

Bargraph Indicators 48 Series

BARGRAPH INDICATOR

Functions & Features

- Small size bargraph indicator
- Displays a process variable in 51-segment bargraph LEDs
- Clear LEDs can be recognized from a distance
- Scale plate can be easily replaced
- Separable terminal block (Separable screwless spring terminal only)
- Displays upper and lower overranges.
- Zero & Span can be adjusted from the unit's front panel.

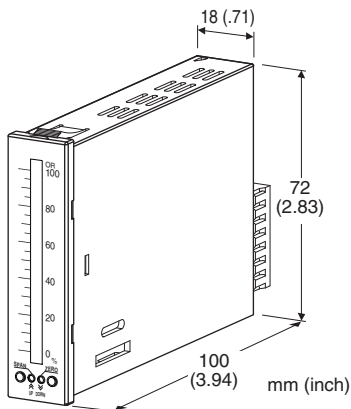

MODEL: 48SV2-[1][2][3][4]-[5]

ORDERING INFORMATION

- Code number: 48SV2-[1][2][3][4]-[5]
- Specify a code from below for each of [1] through [5].
(e.g. 48SV2-RV4WD-R)
- Special input range (For codes Z & 0)
- Bargraph scale (e.g. 0 - 100 %) (See 'SCALE PLATE.')

[1] BAR LED COLOR

- R: Red
- Y: Amber
- G: Green
- B: Blue

[2] MOUNTING DIRECTION

- V: Vertical
- H: Horizontal

[3] INPUT

Current

- A: 4 - 20 mA DC (Input resistance 10 Ω)

- B: 2 - 10 mA DC (Input resistance 20 Ω)
- C: 1 - 5 mA DC (Input resistance 39 Ω)
- D: 0 - 20 mA DC (Input resistance 10 Ω)
- E: 0 - 16 mA DC (Input resistance 12 Ω)
- F: 0 - 10 mA DC (Input resistance 20 Ω)
- G: 0 - 1 mA DC (Input resistance 200 Ω)
- H: 10 - 50 mA DC (Input resistance 5.1 Ω)
- Z: Specify current (See INPUT SPECIFICATIONS)

Voltage

- 3: 0 - 1 V DC (Input resistance 1 MΩ min.)
- 4: 0 - 10 V DC (Input resistance 1 MΩ min.)
- 5: 0 - 5 V DC (Input resistance 1 MΩ min.)
- 6: 1 - 5 V DC (Input resistance 1 MΩ min.)
- 4W: -10 - +10 V DC (Input resistance 1 MΩ min.)
- 5W: -5 - +5 V DC (Input resistance 1 MΩ min.)
- 0: Specify voltage (See INPUT SPECIFICATIONS)

[4] TERMINAL BLOCK

- S: Screwless spring terminal
- D: Separable screwless spring terminal

[5] POWER INPUT

DC Power

- T: 5 V DC
(Operational voltage range 5 V ±10 %, ripple 10 %p-p max.)
- R: 24 V DC
(Operational voltage range 24 V ±15 %, ripple 10 %p-p max.)

SPARE PARTS

- Scale plate

GENERAL SPECIFICATIONS

Construction: Panel flush mounting

Connection

Terminal block "S": Screwless spring terminal

Applicable wire size 0.13 to 1.5 mm², stripped length 8 mm

Terminal block "D": Separable screwless spring terminal

Applicable wire size 0.5 to 1.5 mm², stripped length 7 - 8 mm

Housing material: Flame-resistant resin (gray)

Isolation: Input to power

Zero adjustment accuracy range: -10 - +10 % (front)

Span adjustment accuracy range: 90 to 110 % (front)

Scale plate: Flame resistant resin (white scale & characters on black base)

Zero adj. indicator LED: Green LED turns on at zero adjustment

Span adj. indicator LED: Green LED turns on at span adjustment.

Read rate: 100 samples / sec.

BARGRAPH DISPLAY

LED: 55-segment LED (0 - 100% display: 51)

56 mm (2.2") long, 3.5 mm (.14") wide

Display range: 0 - 100% (No scaling. The first or 55th segment turns on when lower/upper overrange occurs. The 2nd and 54th segments do not turn on.)

Scale

- **Numbers on the scale:** 4 digits max.
(Including decimal point and minus sign)
- **Divisions:** 50 max.
- **Engineering unit:** Max. 4 characters or 2 double-width characters

INPUT SPECIFICATIONS

■ **DC Current:** 0 - 50 mA DC; input resistor incorporated

Minimum span: 1 mA

When specifying a resistance value, choose from below.

5.1 Ω , 10 Ω , 12 Ω , 20 Ω , 39 Ω , 200 Ω

■ **DC Voltage:** -10 - +10 V DC

Input resistance: ≥ 1 M Ω

Minimum span: 0.1 V

Offset: Max. 1.5 times span

INSTALLATION**Power consumption****•DC:**

0.8 W or less @ 5 V rating

1.0 W or less @ 24 V rating

Operating temperature: -5 to +55°C (23 to 131°F)

Operating humidity: 10 to 90 %RH (non-condensing)

Mounting: Panel flush mounting

Weight: 90 g (0.2 lb)

PERFORMANCE in percentage of span

Accuracy: ± 2 % ± 1 digit

Response time: ≤ 0.5 sec.

Insulation resistance: ≥ 100 M Ω with 500 V DC

Dielectric strength: 2000 V AC @ 1 minute

(input to power to ground)

STANDARDS & APPROVALS**EU conformity:**

EMC Directive

EMI EN 61000-6-4

EMS EN 61000-6-2

RoHS Directive

SCALE PLATE

■ WHAT MUST BE SPECIFIED WHEN ORDERING

Following two methods can specify scale plate.

a) Using 'Scale Plate Designer'

Access 'Design Scale Plate' in the M-System web site (in this web site.

english). Scale plate can be designed

By function below, it can be easy to create standard design or original design.

[Design Automatically]

Entering Minimum, Maximum, and Unit allows to create automatically a scale plate. Maximum created scale division number is '50'.

[Specify Division Interval]

Division Interval can be specified according to the application.

[Specify Division Number]

It is available to create originally with scale division number, length of line, position, character size, font and detailed position.

After designing is completed, register code is issued. Place the order with this code.

Once scale plate is designed, it is recorded. The register code can be used any number of times.

b) Specifying scale range and display unit when placing the order

It is available to create by specifying scale range and display unit for right and left.

Regarding design of scale plate such as division number, length of division number line, and character font, they are same as above [Design Automatically], M-System designs them.

■ DESIGNING BY 'DESIGN AUTOMATIFCALLY'

How 'Design Automatically' creates scale design is described succinctly below.

■ TYPES OF DIVISIONS

Five (5) types of divisions are used depending upon the scale span, which determined by the following equation:

$$\text{Scale Span} = (\text{Max. range value} - \text{Min. range value}) \cdot 10^n$$

where n = integer (used to limit the calculated scale span to the minimum of 1.1, below 11.0.)

• Type 1: $1.1 \leq \text{Scale Span} < 1.3$

Number of divisions: 22 to 25.9

Scale: Starts at 0, increments in 0.02 / 0.2 / 2 / 20 / 200.

Min. and max. values are indicated.

4 digits including negative sign and decimal point.

Division lines: Long, Short, Medium, Short, Long
(4 division lines repeating)

• Type 2: $1.3 \leq \text{Scale Span} < 2.0$

Number of divisions: 26 to 39.9

Scale: Starts at 0, increments in 0.03 / 0.3 / 3 / 30 / 300.

Min. and max. values are indicated.

4 digits including negative sign and decimal point.

Division lines: Long, Short, Medium, Short, Medium, Short, Long
(6 divisions repeating)

Minimum Divisions	Maximum Divisions	Bipolar Scale
— 11	— 1.29	— 600
— 10	— 1.2	— 400
— 8	— 1	— 200
— 6	— 0.8	— 0
— 4	— 0.6	— -200
— 2	— 0.4	— -400
— 0	— 0.2	— -600

Minimum Divisions	Maximum Divisions	Bipolar Scale
— 130	— 1.99	— 0.8
— 120	— 1.8	— 0.6
— 90	— 1.5	— 0.3
— 60	— 1.2	— 0.0
— 30	— 0.9	— -0.3
— 0	— 0.6	— -0.6
— 0	— 0.3	— -0.8

• **Type 3: 2.0 Scale Span < 2.6**

Number of divisions: 32 to 41.9

Scale: Starts at 0, increments in 0.05 / 0.5 / 5 / 50 / 500.
Min. and max. values are indicated.

4 digits including negative sign and decimal point.

Division lines: Long, Short, Medium, Short, Medium, Short, Medium, Short, Long
(8 divisions repeating)

Minimum Divisions	Maximum Divisions	Bipolar Scale
20	2.59	120
		100
15	2	50
10	1.5	0
5	1	-50
	0.5	-100
0	0	-120

• **Type 5: 5.5 Scale Span < 11.0**

Number of divisions: 22 to 43.9

Scale: Starts at 0, increments in 0.01 / 0.1 / 1 / 10 / 100 / 1000.
Min. and max. values are indicated.

4 digits including negative sign and decimal point.

Division lines: Long, Medium, Medium, Medium, Long
(5 divisions repeating)

Minimum Divisions	Maximum Divisions	Bipolar Scale
550	10.9	0.5
500	10	0.4
	9	0.3
400	8	0.2
	7	0.1
300	6	0
	5	-0.1
200	4	-0.2
	3	-0.3
100	2	-0.4
	1	-0.4
0	0	-0.5

• **Type 4: 2.6 Scale Span < 5.5**

Number of divisions: 26 to 43.9

Scale: Starts at 0, increments in 0.05 / 0.5 / 5 / 50 / 500.
Min. and max. values are indicated.

4 digits including negative sign and decimal point.

Division lines: Long, Medium, Medium, Medium, Long
(4 divisions repeating)

Minimum Divisions	Maximum Divisions	Bipolar Scale
260	5.49	250
	5	200
	4.5	150
200	4	100
	3.5	50
150	3	0
	2.5	-50
100	2	-100
	1.5	-150
50	1	-200
	0.5	-250
0	0	-250

[Example] : Bargraph range 0 to 300 cm (Type 4)

Scale range: 0 – 300

Scale unit (bargraph): cm

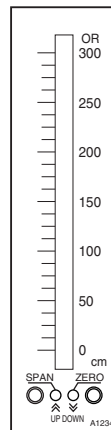

EXTERNAL VIEW

■ VERTICAL MOUNTING

■ HORIZONTAL MOUNTING

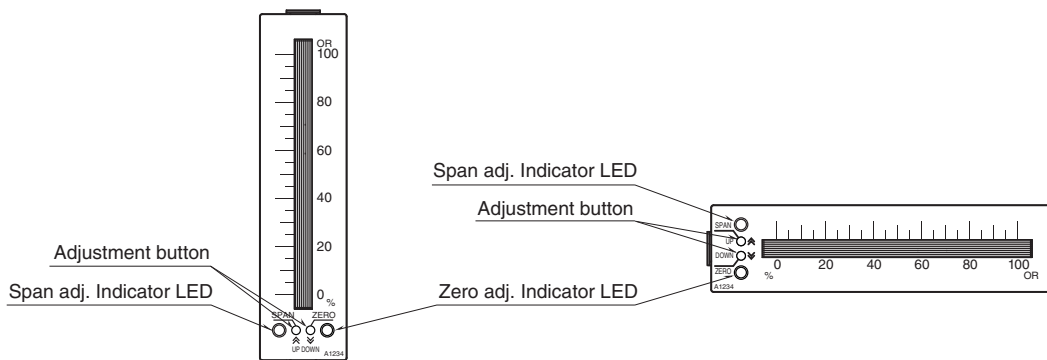

EXTERNAL DIMENSIONS & TERMINAL ASSIGNMENTS unit: mm

■ SCREWLESS SPRING TERMINAL

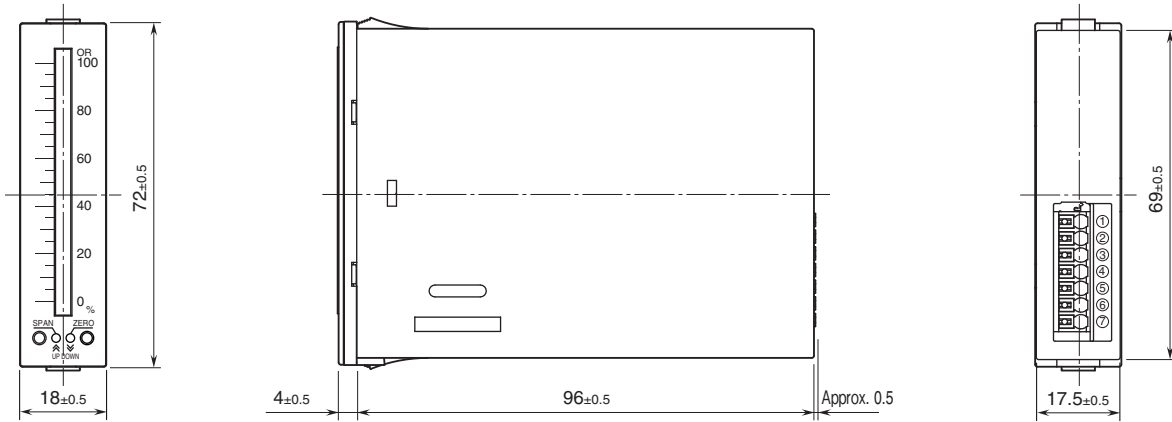

■ SEPARABLE SCREWLESS SPRING TERMINAL

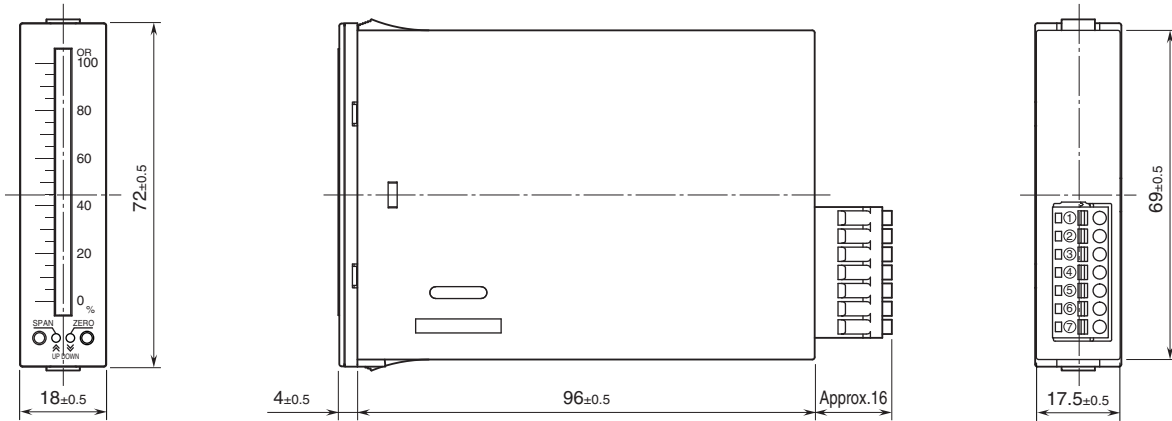

PANEL CUTOUT unit: mm

• VERTICAL MOUNTING

· Single Mounting

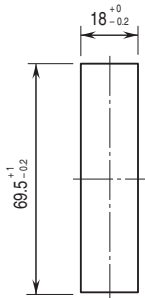

Panel thickness: 0.5 - 2.0

· Clustered Mounting

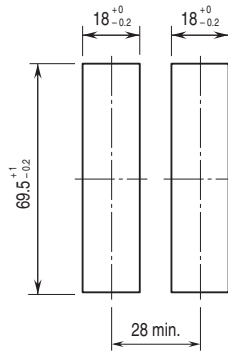

Panel thickness: 0.5 - 2.0

• HORIZONTAL MOUNTING

· Single Mounting

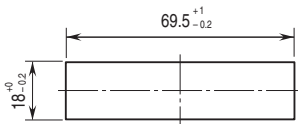

Panel thickness: 0.5 - 2.0

· Clustered Mounting

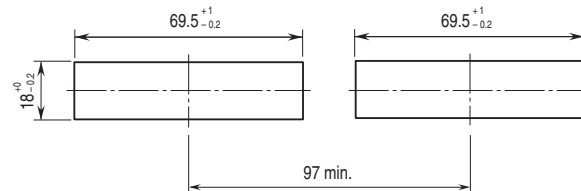

Panel thickness: 0.5 - 2.0

Note 1. When mounting vertically, leave 3 cm or more of space above and below the unit.

1 cm or more of space to right and left the unit.

Note 2. When mounting horizontally, leave 3 cm or more of space above and below the unit.

2.5 cm or more of space to left and right of the unit.

SCHEMATIC CIRCUITRY & CONNECTION DIAGRAM

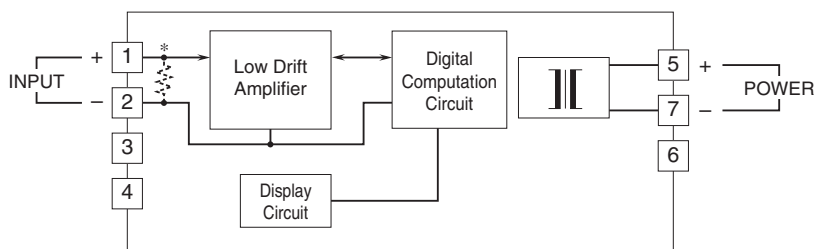

* Input shunt resistor incorporated for current input.



Specifications are subject to change without notice.