

Main

Range of product	OsiSense XS ATEX D
Series name	Application
Sensor type	Inductive proximity sensor
Device application	Rotation monitoring ATEX dust
Sensor name	XSA
Sensor design	Cylindrical M30
Size	81 mm
Body type	Fixed
Detector flush mounting acceptance	Flush mountable
Material	Metal
Enclosure material	Nickel plated brass
[Sn] nominal sensing distance	10 mm
Type of output signal	Discrete
Wiring technique	3-wire
Discrete output function	1 NC
Output circuit type	DC
Discrete output type	PNP
Electrical connection	Cable
Cable length	2 m
[Us] rated supply voltage	12...48 V DC with reverse polarity protection
Switching capacity in mA	<= 200 mA with overload and short-circuit protection
IP degree of protection	IP67 conforming to IEC 60529

Complementary

Thread type	M30 x 1.5
Detection face	Frontal
Front material	PPS
Adjustable frequency range	6...150 cyc/mn
Operating zone	0...8 mm
Differential travel	3...15% of Fr
Repeat accuracy	3% of Sr
Cable composition	3 x 0.34 mm ²
Wire insulation material	PvR
Status LED	1 LED red (output state)
Supply voltage limits	10...58 V DC
Switching frequency	<= 100 Hz
Voltage drop	<= 1.8 V, closed state contact(s)
Current consumption	0...15 mA, no-load
Run-up delay at power-up	9 s standard
Marking	II2 D-Ex tb IIIC T90°C Db IP67
Threaded length	57 mm
Height	30 mm
Length	81 mm

Environment

Standards	EN/IEC 60079-0 EN/IEC 60079-31
Directives	2014/34/EU - ATEX directive
Product certifications	INERIS 04ATEX0022X IEC-Ex INE 17.0006
Ambient air temperature for operation	-20...60 °C
Dust zone	Zone 21 - 22

Offer Sustainability

Sustainable offer status	Green Premium product
RoHS (date code: YYWW)	Compliant - since 0945 - Schneider Electric declaration of conformity Schneider Electric declaration of conformity
REACH	Reference not containing SVHC above the threshold
Product environmental profile	Available Product Environmental
Product end of life instructions	Available End Of Life Manual

Contractual warranty

Warranty period	18 months 18 months
-----------------	---------------------

Dimensions

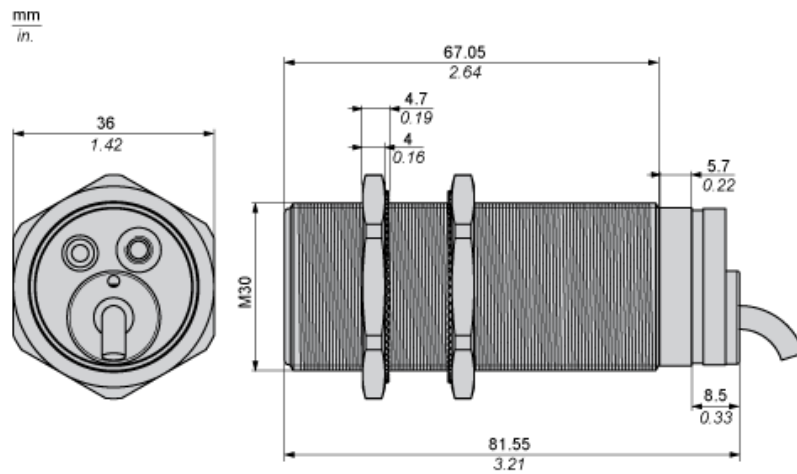

(1) LED

Minimum Mounting Distances

Side by side



e (1) 20 mm/0.79 in

≥

Face to face



e (2) 120 mm/4.72 in

≥

Facing a metal object



e (3) 30 mm/1.18 in.

≥

Wiring Schemes

3-wire DC

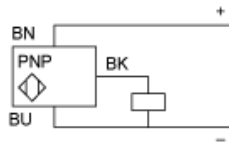

BU : Blue
BN : Brown
BK : Black

Performance Curves

Standard Steel Target : 30x30x1 mm



- (1) Pick-up points
- (2) Drop-out points (object approaching from the side)
- (y) Sensing distance in mm