

Limit switches

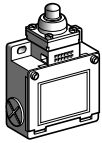

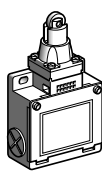

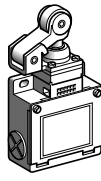

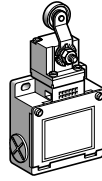
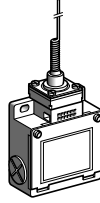



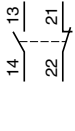









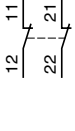









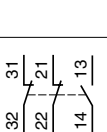

OsiSense XC Standard, Classic format
Metal, type XCK M
Complete switches with 3 cable entries

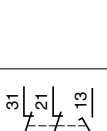
1

Type of head	Plunger (fixing by the body)	Rotary (fixing by the body)	Multi-directional, (fixing by the body)
			
			



Type of operator	Metal end plunger	Steel roller plunger	Thermoplastic roller lever plunger, horizontal actuation in 1 direction	Thermoplastic roller lever (1)	"Cat's whisker" (2)
------------------	-------------------	----------------------	---	--------------------------------	---------------------

References of complete switches with 3 ISO M20 x 1.5 cable entries (3)

2-pole NC + NO snap action (XE2S P2151)	 XCK M110H29 1.8 4.5(P) 0.9 5.5mm	 XCK M102H29 3.1(A) 7.8(P) 1.5 mm	 XCK M121H29 4.6(A) 11.1(P) 2.2 mm	 XCK M115H29 26° 58°(P) 11° 70°	 XCK M106H29 30° 14°
2-pole NC + NO break before make, slow break (XE2N P2151)	 XCK M510H29 1.8 3.2(P) 0 5.5mm	 XCK M502H29 3.1(A) 5.6(P) 0 5.2 mm	 XCK M521H29 4.6(A) 8(P) 0 7.6 mm	 XCK M515H29 26° 42°(P) 0 36° 70°	 XCK M506H29 30° 0 40°
2-pole NC + NC snap action (XE2S P2141)	 ZCK M9H29 + ZCK D10 1.8 4.5(P) 0.9 5.5mm	 ZCK M9H29 + ZCK D02 3.1(A) 7.8(P) 1.5 mm	 ZCK M9H29 + ZCK D21 4.6(A) 11.1(P) 2.2 mm	 ZCK M9H29 + ZCK D15 26° 58°(P) 11° 70°	 ZCK M9H29 + ZCK D06 30° 14°
2-pole NC + NC simultaneous, slow break (XE2N P2141)	 ZCK M7H29 + ZCK D10 1.8 3.2(P) 0 5.5mm	 ZCK M7H29 + ZCK D02 3.1(A) 5.6(P) 9mm	 ZCK M7H29 + ZCK D21 8(P) 4.6(A) mm	 ZCK M7H29 + ZCK D15 42°(P) 26° 70°	 ZCK M7H29 + ZCK D06 30°
3-pole NC + NC + NO snap action (XE3S P2141)	 ZCK MD39H29 + ZCK D10 1.8 4.5(P) mm 0.9 5.5	 ZCK MD39H29 + ZCK D02 3.1(A) 7.8(P) mm 1.5	 ZCK MD39H29 + ZCK D21 4.6(A) 11.1(P) mm 2.2	 ZCK MD39H29 + ZCK D15 26° 58°(P) 11° 70°	 ZCK MD39H29 + ZCK D06 30° 14°
3-pole NC + NC + NO break before make, slow break (XE3N P2141)	 ZCK MD37H29 + ZCK D10 1.8 3.2(P) mm 0 3 5.5	 ZCK MD37H29 + ZCK D02 3.1(A) 3.2(P) mm 0 5.2 5.5	 ZCK MD37H29 + ZCK D21 4.6(A) 8(P) mm 0 7.6	 ZCK MD37H29 + ZCK D15 26° 42°(P) 0 36° 70°	 ZCK MD37H29 + ZCK D06 30° 0 40°
Weight (kg)	0.250	0.255	0.300	0.280	0.250
Contact operation	 closed  open	(A) = cam displacement (P) = positive opening part		 NC contact with positive opening operation	

References of complete switches with 3 Pg 11 cable entries

For complete switches with 3 Pg 11 cable entries, delete H29 from the end of the reference. Example: XCK M110H29 becomes XCK M110.

Characteristics	On end	By 30° cam	By any moving part
Switch actuation	On end	By 30° cam	By any moving part
Type of actuation			
Maximum actuation speed	0.5 m/s	1.5 m/s	1 m/s (any direction)
Mechanical durability (4) (in millions of operating cycles)	20	15	10
Minimum force or torque	For tripping: 15 N For positive opening: 45 N	12 N 36 N	8 N 24 N
Cable entry	3 entries tapped M20 x 1.5 mm for ISO cable gland, clamping capacity 7 to 13 mm		

(1) Adjustable throughout 360° in 5° steps, or in 90° steps by reversing the notched washer.
 (2) Value taken with actuation by moving part at 100 mm from the fixing.
 (3) Switches with gold contacts or eyelet type connections: please consult our Customer Care Centre.
 (4) Limited to 15 million operating cycles for switches with contacts XE3●P.

Limit switches

OsiSense XC Standard, Classic format

Metal, type XCK M

Complete switches with 3 cable entries

XCK M●10
ZCK MD3● + ZCK D10

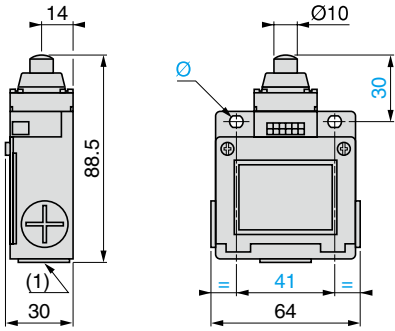

XCK M●02
ZCK MD3● + ZCK D02

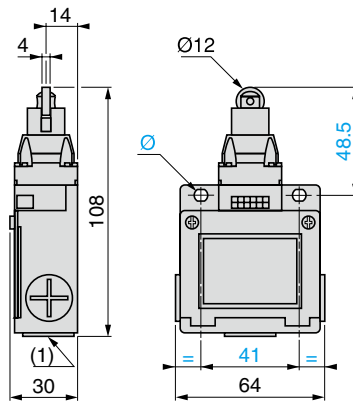

XCK M●21
ZCK MD3● + ZCK D21

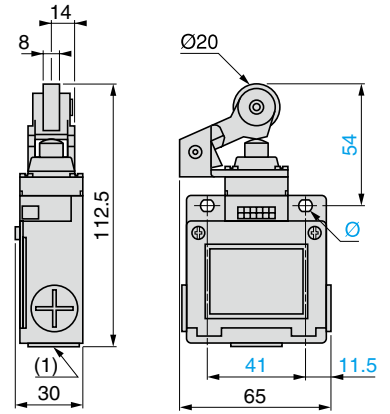

XCK M●15
ZCK MD3● + ZCK D15

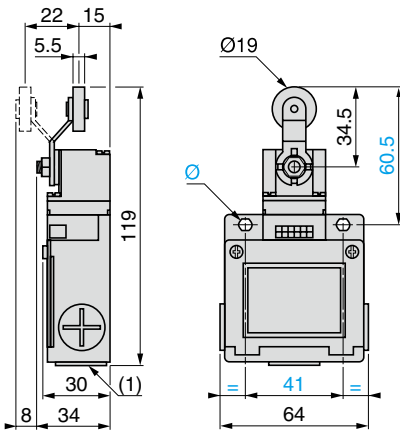

XCK M●06
ZCK MD3● + ZCK D06

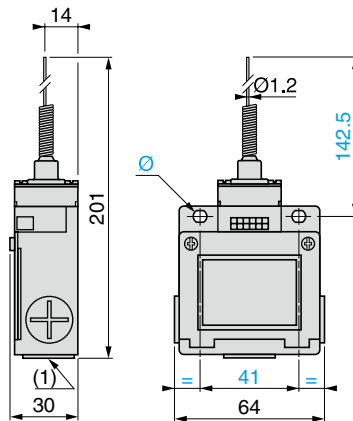

Rear view XCK M●●●, ZCK M●, ZCK MD3●

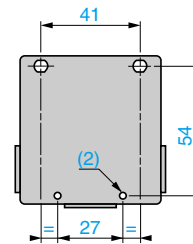

(1) 3 tapped entries for ISO M20 x 1.5 or Pg 11 cable gland or with 1/2" NPT conduit adaptor DE9 RA1012.

(2) 2 x Ø 4 H 11, depth 10.

Ø: 2 elongated holes Ø 5.2 x 6.2

Adaptor for 1/2" NPT conduit
DE9 RA1012

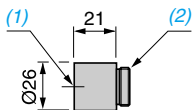

(1) Tapped entry for 1/2" NPT conduit.

(2) Threaded sleeve.

Limit switches

OsiSense XC Standard, Classic format
Metal, types XCK M, XCK L and XCK ML

1

■ XCK M,
with 3 cable entries

□ With head for linear movement
(plunger)

□ With head for rotary movement
(lever) or multi-directional

561643

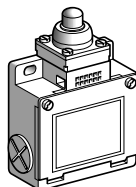

561644

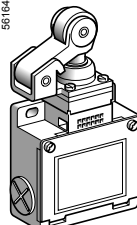

808148

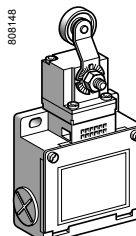

561645

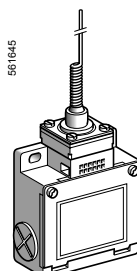

Page 1/76

■ XCK L,
with 1 cable entry

□ With head for linear movement
(plunger)

□ With head for rotary movement
(lever) or multi-directional

808140

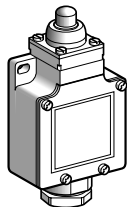

808145

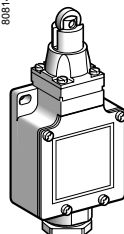

808141

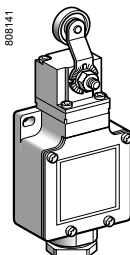

808147

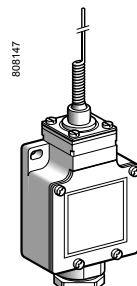

Page 1/78

■ XCK ML,
with 3 cable entries and 2 x 2-pole contacts

□ With head for linear movement
(plunger)

□ With head for rotary movement
(lever)

561639

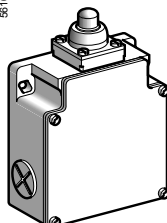

561640

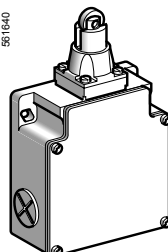

561641

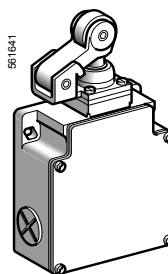

561642

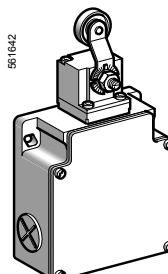

Page 1/80

Environment characteristics

Conformity to standards	Products	IEC 60947-5-1, EN 60947-5-1, UL 508, CSA C22-2 n° 14
	Machine assemblies	IEC 60204-1, EN 60204-1
Product certifications		UL, CSA, CCC (only for XCK M)
Protective treatment	Version	Standard: "TC". Special: "TH"
Ambient air temperature	For operation	- 25...+ 70°C
	For storage	- 40...+ 70°C
Vibration resistance	Conforming to IEC 60068-2-6	25 gn (10...500 Hz)
Shock resistance	Conforming to IEC 60068-2-27	50 gn (11 ms)
Electric shock protection		Class I conforming to IEC 61140 and NF C 20-030
Degree of protection		IP 66 conforming to IEC 60529; IK 05 conforming to EN 50102
Repeat accuracy		XCK ML 0.1 mm; XCK M and XCK L 0.05 mm on the tripping points, with 1 million operating cycles for head with end plunger
Cable entry or connector	Depending on model	XCK M : 3 tapped entries for n° 11 cable gland or tapped ISO M20, or with 1/2" NPT adaptor XCK L : 1 tapped entry incorporating cable gland or 1 entry tapped 1/2" NPT XCK ML : 3 tapped entries for n° 13 cable gland or tapped ISO M20
Materials		Bodies: zamak. Rotary heads: zamak or plastic, depending on product reference. Other heads: plastic

Contact block characteristics		
Rated operational characteristics	XE2● P	~ AC-15; A300 (Ue = 240 V, Ie = 3 A); Ithe = 10 A --- DC-13; Q300 (Ue = 250 V, Ie = 0.27 A), conforming to IEC 60947-5-1 Appendix A, EN 60947-5-1
	XE3● P	~ AC-15; B300 (Ue = 240 V, Ie = 1.5 A); Ithe = 6 A --- DC-13; R300 (Ue = 250 V, Ie = 0.1 A), conforming to IEC 60947-5-1 Appendix A, EN 60947-5-1
Rated insulation voltage	XE2● P	Ui = 500 V degree of pollution 3 conforming to IEC 60947-1 Ui = 300 V conforming to UL 508, CSA C22-2 n° 14
	XE3● P	Ui = 400 V degree of pollution 3 conforming to IEC 60947-1 Ui = 300 V conforming to UL 508, CSA C22-2 n° 14
Rated impulse withstand voltage	XE2● P XE3● P	U imp = 6 kV conforming to IEC 60947-1, IEC 60664 U imp = 4 kV conforming to IEC 60947-1, IEC 60664
Positive operation (depending on model)		NC contacts with positive opening operation conforming to IEC 60947-5-1 Appendix K, EN 60947-5-1
Resistance across terminals		≤ 25 mΩ conforming to IEC 60255-7 category 3
Short-circuit protection	XE2● P	10 A cartridge fuse type gG (gl)
	XE3● P	6 A cartridge fuse type gG (gl)
Connection (screw clamp terminals)	XE2S P21●1	Clamping capacity, min: 1 x 0.34 mm ² , max: 2 x 1.5 mm ²
	XE2N P21●1	Clamping capacity, min: 1 x 0.5 mm ² , max: 2 x 2.5 mm ²
	XES P2151L and XEN P2151L	Clamping capacity, min: 1 x 0.34 mm ² , max: 2 x 1.5 mm ² or 1 x 2.5 mm ²
	XE3N P and XE3S P	Clamping capacity, min: 1 x 0.34 mm ² , max: 1 x 1 mm ² or 2 x 0.75 mm ²
Minimum actuation speed		XE2S P21●1, XES P2151L and XE3S P: 0.01 m/minute XE2N P21●1, XEN P2151L and XE3N P: 6 m/minute

Electrical durability

- Conforming to IEC 60947-5-1 Appendix C
- Utilisation categories AC-15 and DC-13
- Maximum operating rate: 3600 operating cycles/hour
- Load factor: 0.5

AC supply
50/60 Hz ~
mm inductive circuit

XE2S P21●1, XE2S P2141, XES P2151L

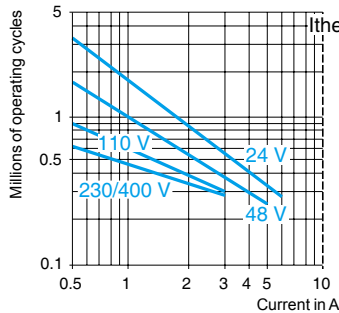

XE2N P21●1, XEN P2151L

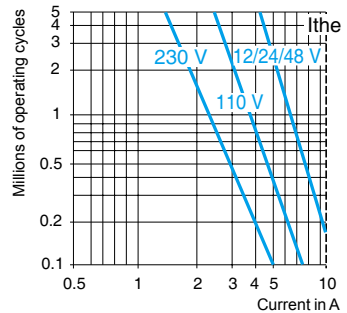

DC supply ---

Power broken in W for 5 million operating cycles.

Voltage	V	24	48	120
mm	W	10	7	4

Power broken in W for 5 million operating cycles.

Voltage	V	24	48	120
mm	W	13	9	7

For XE2S P●151 on ~ or ---, NC and NO contacts simultaneously loaded to the values shown with reverse polarity.

AC supply
50/60 Hz ~
mm inductive circuit

XE3S P●●●●

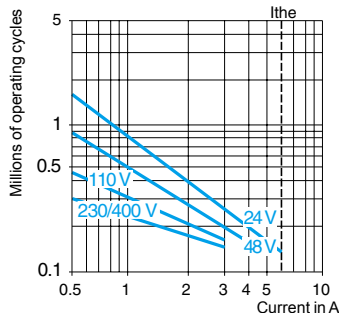

XE3N P●●●●

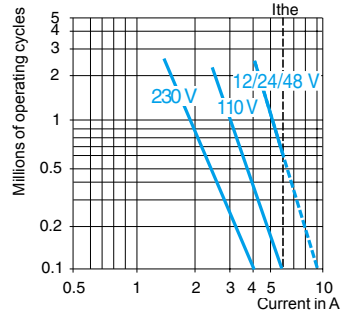

DC supply ---

Power broken in W for 5 million operating cycles.

Voltage	V	24	48	120
mm	W	3	2	1

Power broken in W for 5 million operating cycles.

Voltage	V	24	48	120
mm	W	4	3	2