

**NEW FAN TYPE IONIZER**

ER-F SERIES



Compact size of 150 × 166 × 62 mm  
(5.906 × 6.535 × 2.441 in)

Low-volume fan type also available for various applications



**Standard fan type  
ER-F12**

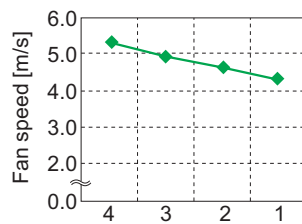

Fan speed select switch

**Low-volume fan type  
ER-F12S**

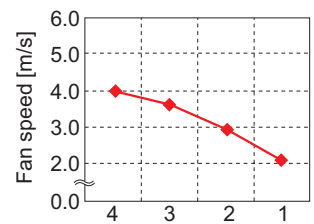

Fan speed select switch

- An ionizer with a 120 mm 4.724 in fan diameter that has a class leading compact size for reducing workbench clutter and increasing efficiency.
- Low-volume fan type with a suppressed fan speed of approx. half is available for charge removal in processes which involve handling of small parts or thin films.

\* Graphs represent typical values at 300mm 11.811 in from directly in front of air outlet, straight louver, with no filter installed.

**Two exchangeable  
louvers to suit your  
needs**

- Just simply replace the louver to change configuration between long distance and wide area ionization.
- The two louvers come with the ionizer main body.

**Straight louver**



Removes charges quickly at long distance

**Angle louver**



Removes charges completely in wide area

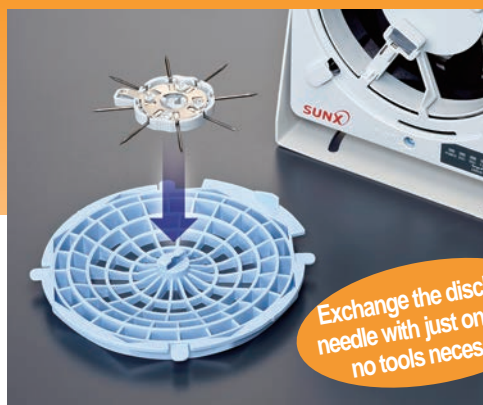

Exchange the discharge needle with just one click, no tools necessary.

**Remove the louver for  
effortless maintenance**

- Because the discharge needle unit is attached to the louver, exchange or maintenance of the needles is made easy without touching the main unit.
- A safe design where once the louver is removed, the high-voltage circuit and the fan will halt.

## SPECIFICATIONS

Type	Standard fan type	Low-volume fan type
Model No.	<b>ER-F12</b>	<b>ER-F12S</b>
Charge removal time	1 sec. approx. (Note 1)	1.5 sec. approx. (Note 1)
Ion balance	±10 V or less (Note 2)	
Power supply voltage	24 V DC ±10%	
Power consumption	700 mA or less	400 mA or less
Discharge method	High-frequency AC method	
Discharge output voltage	± 2 kV approx.	
Max. fan speed	5.3 m/s (Note 2)	4.0 m/s (Note 2)
Max. fan volume	3.68 m <sup>3</sup> /min	2.50 m <sup>3</sup> /min
Main functions	Error output, Discharge halt input	
Indicators	Discharge error (Red), Fan error (Red), Power (Green), Discharge (Green)	
Ozone generation amount	0.04 ppm or less (Note 1)	
Ambient temperature	0 to +50°C 32 to 122°F (No dew condensation) / Storage: -10 to +65°C 14 to 149°F	
Ambient humidity	35 to 65% RH (No dew condensation) / Storage: 35 to 65% RH	
Grounding method	C (capacitor) grounding	
Material	Enclosure: ABS, Louver: ABS, Discharge needle unit: PBT Discharge needle: Tungsten, Bracket: SPHC	
Weight	Main unit: 790 g approx.	
Accessories	Straight louver: 1 pc. (Note 3), Angle louver: 1 pc. Caution label: 1 set, Rubber cushion: 1 pc.	

- Notes: 1) Typical value at 200 mm 7.874 in from directly in front of air outlet, fan speed MAX, straight louver, with no filter installed.  
 2) Typical value at 300 mm 11.811 in from directly in front of air outlet, fan speed MAX, straight louver, with no filter installed.  
 3) The discharge needle unit is loaded on the straight louver before shipment.

## DIMENSIONS (Unit: mm in)

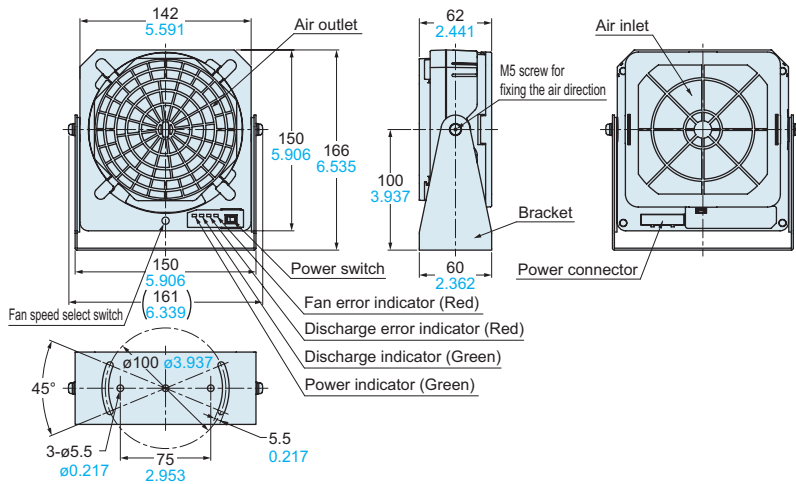

## OPTIONS

- ER-FAPS-J2, ER-FAPS-EX** (Note) / AC adapter  
 • IN: 100 to 240 V AC 50 / 60 Hz • OUT: 24 V DC, 2.0 A  
 • Cable length between connector and AC adaptor: 1.8 m 5.905 ft  
 • AC cable: 125 V rated (an accessory to **ER-FAPS-J2** only)

Note: Please prepare an AC cable separately as it is needed.

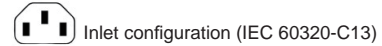

- ER-F12ANT** / Discharge needle unit  
 Unit with tungsten needles (1 pc.)

- ER-F12FX5** / Air filter  
 Replacement filter (5 pcs. per set)

## CHARGE REMOVAL CHARACTERISTICS (TYPICAL)

Measured using a □150 mm □5.906 in CPM (charge plate monitor)  
 (At center of CPM)

\* Solid lines in the graphs show **ER-F12**. Dotted lines show **ER-F12S**.

Charge removal field (Fan speed MAX, straight louver is mounted)

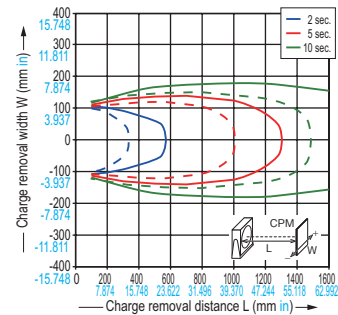

Charge removal field (Fan speed MAX, angle louver is mounted)

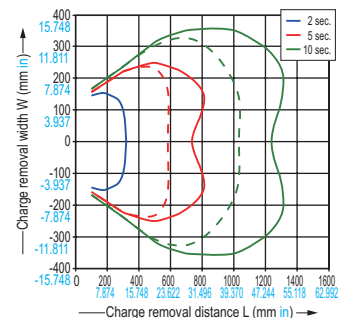

## PRECAUTIONS FOR PROPER USE

- This product does not possess control functions for safety assurance such as accident prevention.
- This product has been developed / produced for industrial use.
- Do not use this product in places where there may be a danger of flammable or combustible items being present.
- If this product is used in an airtight room, ozone emitted from this product may be detrimental. Therefore, in order for this product to be used in an airtight room, be sure to keep the room ventilated.
- Since the tip of the discharge needle is sharp, take sufficient care in handling the discharge needle.
- Clean the discharge needle regularly, otherwise optimum charge removal performance may not be obtained and fire or operating problems may occur.
- Be sure to ground the frame ground (F.G.) terminal.

All information is subject to change without prior notice.