

Variable speed drives Altivar Process ATV900

Catalog

October 2016



Schneider
Electric

General contents

■ General presentation.....	page 2
<i>IP 21, IP 54 or IP 55 variable speed drive selection guide</i>	<i>page 4</i>
<i>IP 23 or IP 54 Drive Systems selection guide</i>	<i>page 6</i>
■ Altivar Process ATV900 variable speed drives presentation	page 8
■ Altivar Process ATV900 Drive Systems presentation	page 16
Altivar Process ATV900 variable speed drives	
■ 200...240 V 50/60 Hz supply, IP 21/UL Type 1	page 18
■ 380...480 V 50/60 Hz supply	page 19
□ IP 21/UL Type 1, with integrated category C2 or C3 EMC filter	page 19
□ IP 55, with integrated category C2 or C3 EMC filter	page 21
□ IP 55, with Vario disconnect switch and integrated category C2 or C3 EMC filter	page 22
■ 380...440 V 50/60 Hz supply	page 20
□ IP 21, floor standing, with integrated category C3 EMC filter	page 20
□ IP 54, floor standing, with integrated category C3 EMC filter	page 23
■ Replacement parts	page 24
■ Accessories	page 25
■ Graphic display terminal.....	page 26
■ Accessories	page 27
■ Web server	page 28
■ DTM libraries and SoMove setup software	page 29
Options	
■ Drive/option combinations	page 30
■ Encoder modules and I/O expansion modules	page 34
■ Communication buses and networks	page 36
■ Braking units and resistors	page 42
■ Passive filters	page 46
■ EMC filters	page 52
■ dv/dt filters	page 54
■ Sinus filters	page 56
■ Common mode filters	page 58
Motor starters	
■ 200...240 V 50/60 Hz supply	page 60
■ 380...415 V 50/60 Hz supply	page 61
■ 440 V 50/60 Hz supply	page 63
Dimensions	
■ Drives	page 66
■ Options	page 70
Services	
■ A whole world of services for your drives.....	page 74
Index	
■ Product reference index.....	page 76

Variable speed drives

Altivar Process ATV900

Process efficiency, real-time intelligence

Altivar Process

Provides the efficiency you deserve

Altivar Process is the new comprehensive range of variable speed drives from Schneider Electric covering the majority of industrial applications with 2 series:

- > ATV600: drives focused on fluid management and processing and energy saving
- > ATV900: drives focused on maximum productivity with exceptional motor control and connectivity

Wall-mounting drives, built-in cabinet, and floor-standing solutions are available with IP 21, IP 23, IP 54, and IP 55 protection degrees, according to customer requirements.

Wall-mounting drives from 0.75 kW to 315 kW

Floor-standing drives from 110 kW to 315 kW

Drive Systems from 110 kW to 800 kW

From basic design to customized offer



Altivar Process drives

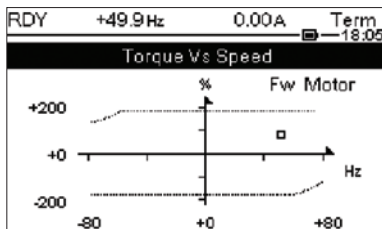

Display screen

Process efficiency

Motor performance and connectivity

- > Excellent motor performance on any type of motor
- > Dual port Ethernet offers maximum services such as connection to the control room and process transparency
- > Network service helps ensure operation continuity even in case of connection breakdown
- > Web server and data logging help reduce downtime through fast troubleshooting and preventive maintenance

Complete control of your applications

- > Maximize your application performance by using Drive-to-Drive communication: total control of any kind of coupling in master/slave applications
- > Total management and flexibility of speed and torque on rigid and elastic coupling
- > Asset monitoring functions to increase production and reduce downtime

Real-time intelligence

Web server and services via Ethernet

- > Embedded web server interface based on the Ethernet network gives you process monitoring with your daily working tools.
- > Local and remote access to energy use and customized dashboards means your energy is visible anywhere, any time, on PC, tablet, or smartphone.



+ Motor control application performance



ODVA organization:
Supports network technologies based on EtherNet/IP



FDT Technology: An international standard with broad acceptance in the automation industry



Achilles™ Level 2 certified



User-friendliness

Simple integration in PLC environments

- > Easy integration thanks to standardized FDT/DTM and ODVA technology
- > Supported by predefined Unity Pro libraries
- > Easy access via PC, tablet, or smartphone
- > Secure connection via “Cyber-secure Ethernet”

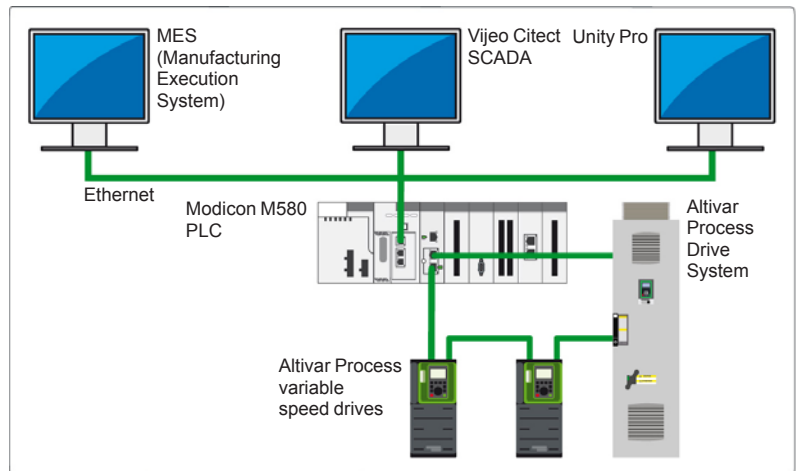

Integration in the Modicon M580 automation platform



Scanning the QR code from a smartphone or tablet

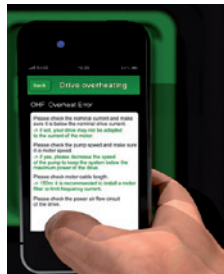

Instant access to online help

Sophisticated service concept

- > Modular design provides easy spare parts logistics
- > Optimized maintenance costs due to dynamic maintenance schedule, with integrated monitoring of individual components
- > Simple exchange of power modules and fans
- > Quick assistance with dynamic QR codes and Customer Care App



Green product

Designed to have a smaller carbon footprint

- > The Green Premium product label, Schneider Electric's eco-mark, indicates your compliance with international environmental standards such as:
 - > RoHS-2 according to EU directive CE 2002/95
 - > REACH according to EU regulation 1907/2006
 - > IEC 62635: The end-of-life instructions comply with the latest recycling rules, 70% of the product components can be recycled.

+ Best in class service concept

IP 21, IP 54, or IP 55 variable speed drives for asynchronous and synchronous motors

Market segments

- Oil & gas
- Mining, minerals & metals
- Food & beverage
- Water & wastewater



Mounting type	Wall-mounting	Floor-standing
Degree of protection	IP 21/UL Type 1	IP 21 without braking unit
Power range for 50...60 Hz line supply (1)	Three-phase: 200...240 V (kW/HP)	0.75...45/1...60
	Three-phase: 380...440 V (kW)	–
	Three-phase: 380...480 V (kW/HP)	110...315
Drive	Output frequency	0.75...220/1...350
	Control type	0.1...500 Hz
Functions	Advanced functions	Standard constant torque, optimized torque mode
	Integrated safety function	PM (Permanent Magnet) motor
Number of integrated I/O	Analog inputs	16
	Digital inputs	3: Configurable as voltage (0...±10 V) or current (0-20 mA/4-20 mA), including 2 for probes (PTC, PT100, PT1000, or KTY84)
I/O extension modules (optional)	Digital outputs	8: Voltage 24 V ⎓ (positive or negative logic)
	Relay outputs	1: Assignable
Relay output module (optional)	Relay outputs	2: Configurable as voltage (0...10 V) or current (0-20 mA)
	Communication	3: 1 with NO/NC contacts and 2 with NO contacts
Configuration and runtime tools	Option modules	2: For safety function STO
	Standards and certifications	2 differential analog inputs configurable via software as current (0-20 mA/ 4-20 mA), or for PTC, PT100 or PT1000, 2 or 3-wire
References	Option modules	6: Voltage 24 V ⎓ (positive or negative logic)
	Page	2: Assignable

Mounting type	Wall-mounting	Floor-standing
Degree of protection	IP 21/UL Type 1	IP 21 without braking unit
Power range for 50...60 Hz line supply (1)	Three-phase: 200...240 V (kW/HP)	0.75...45/1...60
	Three-phase: 380...440 V (kW)	–
	Three-phase: 380...480 V (kW/HP)	110...315
Drive	Output frequency	0.75...220/1...350
	Control type	0.1...500 Hz
Functions	Advanced functions	Standard constant torque, optimized torque mode
	Integrated safety function	PM (Permanent Magnet) motor
Number of integrated I/O	Analog inputs	16
	Digital inputs	3: Configurable as voltage (0...±10 V) or current (0-20 mA/4-20 mA), including 2 for probes (PTC, PT100, PT1000, or KTY84)
I/O extension modules (optional)	Digital outputs	8: Voltage 24 V ⎓ (positive or negative logic)
	Relay outputs	1: Assignable
Relay output module (optional)	Relay outputs	2: Configurable as voltage (0...10 V) or current (0-20 mA)
	Communication	3: 1 with NO/NC contacts and 2 with NO contacts
Configuration and runtime tools	Option modules	2: For safety function STO
	Standards and certifications	2 differential analog inputs configurable via software as current (0-20 mA/ 4-20 mA), or for PTC, PT100 or PT1000, 2 or 3-wire
References	Option modules	6: Voltage 24 V ⎓ (positive or negative logic)
	Page	2: Assignable

ATV930●●●●● | ATV930●●●●●C | ATV930●●●●●F

(1) In "Normal duty" power values are given for applications requiring a slight overload (up to 120%). For power values in "Heavy duty" applications requiring a significant overload (up to 150%), see page 18.

- Oil & gas
- Mining, minerals & metals
- Food & beverage
- Water & wastewater



Mounting type	Wall-mounting	Floor-standing
Degree of protection	IP 55	IP 55 with Vario disconnect switch
Power range for 50...60 Hz line supply (1)	Three-phase: 200...240 V (kW/HP)	0.75...90/1...125
	Three-phase: 380...440 V (kW)	–
	Three-phase: 380...480 V (kW/HP)	110...315
Drive	Output frequency	0.1...500 Hz
	Control type	Standard constant torque, optimized torque mode
Functions	Advanced functions	PM (Permanent Magnet) motor
	Integrated safety function	Performance on motor control with an overload torque up to 180% Tn in an open or closed loop
Number of integrated I/O	Analog inputs	■ Asynchronous, synchronous, special motors: all efficiency classes, brand independent, permanent magnet motors, torque motors, conical sliding rotor, reluctance motor
	Digital inputs	■ Integrated EtherNet/IP and Modbus TCP dual port, cybersecurity (Achilles Level 2)
I/O extension modules (optional)	Digital outputs	■ Smart integration in PlantStruxure and Foxboro Evo Process Automation Systems
	Relay outputs	■ Optimized Energy Efficiency, detection of energy consumption drift of the installation
Relay output module (optional)	Relay outputs	■ Adaptation to the process by dedicated functions with modular design
	Communication	■ Embedded safety functions STO SIL3
Configuration and runtime tools	Option modules	■ Master/slave and load sharing with drive-to-drive capability:
	Standards and certifications	□ torque sharing on rigid coupling
References	Option modules	□ torque sharing on elastic coupling
	Page	■ Contextual access to technical documentation through dynamic QR code

ATV950●●●●● | ATV950●●●●●E | ATV950●●●●●F

(1) In "Normal duty" power values are given for applications requiring a slight overload (up to 120%). For power values in "Heavy duty" applications requiring a significant overload (up to 150%), see page 18.

IP 23 and IP 54 Drive Systems for asynchronous and synchronous motors

Market segments

- Oil & gas
- Mining, minerals & metals
- Food & beverage
- Water & wastewater



Power range for 50...60 Hz line supply	Three-phase: 380...415 V (kW)
Main characteristics	
Variants	
Degree of protection	
Drive	Output frequency Control type
Communication	Integrated Option modules
Interfaces	
Type of drive	
Page	

90...800
High Performance Drive Systems with an integrated line reactor to reduce the current harmonics THDI < 48%
High Performance standard offer Modular with integrated options (ETO) User-definable on request (Full ETO)
IP 23 IP 54 with separate air flows as an option
0.1...500 Hz Standard constant torque, optimized torque mode PM (Permanent Magnet) motor
EtherNet/IP and Modbus/TCP dual port, Modbus serial link PROFINET, CANopen RJ45 Daisy Chain, Sub-D and screw terminals, Profibus DP V1, EtherCAT and DeviceNet
Operating panel in the enclosure door Control terminals inside the enclosure Control terminals can be extended Reading of the parameters via USB interface on the keypad
ATV960●●●Q4X1
For further information, please consult your local Schneider Electric drives expert.

- Oil & gas
- Mining, minerals & metals
- Food & beverage
- Water & wastewater



90...800
Regenerative Drive Systems with active mains rectifier to reduce the current harmonics THDI < 5%
Regenerative standard offer Modular with integrated options (ETO) User-definable on request (Full ETO)
IP 23 IP 54 with separate air flows as an option
0.1...500 Hz Standard constant torque, optimized torque mode PM (Permanent Magnet) motor
EtherNet/IP and Modbus/TCP dual port, Modbus serial link PROFINET, CANopen RJ45 Daisy Chain, Sub-D and screw terminals, Profibus DP V1, EtherCAT and DeviceNet
Operating panel in the enclosure door Control terminals inside the enclosure Control terminals can be extended Reading of the parameters via USB interface on the keypad
ATV980●●●Q4X1
For further information, please consult your local Schneider Electric drives expert.



Altivar Process range

Process automation

The Altivar Process is an IP 21, IP 23, IP 54, or IP 55 variable speed drive for three-phase synchronous and asynchronous motors, specially designed for the following market segments:

- Oil & gas
- Mining, minerals & metals
- Food & beverage
- Water & wastewater

The Altivar Process 900 series is focused on maximum productivity with exceptional motor control and connectivity.

It offers special functionalities for the industrial process segments:

- Excellent motor performance on any type of motor
- Total control of any kind of coupling in master/slave applications
- Network services help ensure operation continuity even in case of connection breakdown
- Web server and data logging help reduce downtime through fast troubleshooting and preventive maintenance

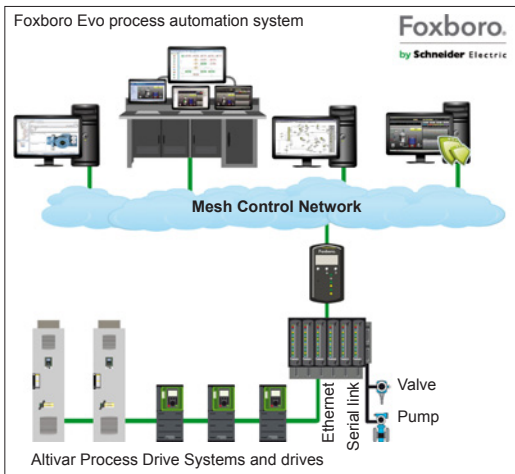

Altivar Process in Foxboro Evo DCS architecture

The association of Altivar Process services with Schneider Electric process automation control systems like Foxboro Evo (for process systems) or M580 ePAC (for hybrid systems) offers a high-performance, global automation and motor control solution with optimized total cost of ownership (TCO).

The solution provides operational integrity for people, processes, and assets, with improved maintenance support to reduce downtime and help ensure operation continuity.

It offers operational insight by accessing more information to optimize the process and to control the energy efficiency.

Based on market standards (FDT/DTM, Ethernet, etc.), it is a sustainable, scalable solution that enables processes to be adapted easily and affordably.



Oil & gas applications

- Hydrocarbon production:
 - Drilling
 - Offshore and onshore extraction
 - Water treatment and re-injection
 - Crude oil storage
 - Separation
 - Pipeline pumping
 - Storage
 - Refining
 - DOF (Digital Oil Field)

Use

- PCP (Progressive Cavity Pump)
- ESP (Electrically Submersible Pump)
- Rod pump
- Mud pump
- Rotary table, top drive
- Draw works
- Regasification compressor



Process automation (continued)

Mining, minerals & metals applications

- Open-pit or underground mining
- Stockpiling/homogenization
- Concentration/mineral separation
- Solid-liquid separation
- Final handling/transport
- Clinker production
- Cement production

Use

- Long distance heavy conveying
- Bucket wheel excavator
- Special cranes:
 - Gantry cranes
 - Grab cranes
- Crushing
- Grinding mills (ball mills, SAG and AG mills)
- Spiral and magnetic separators
- Reclaimers and stackers
- Ship loaders
- Mobile miner
- Vibro feeders
- Crusher
- Long belt conveyor
- Kiln main drive
- Separator for VRM (Vertical Roller Mill)



Food & beverage applications

- Dairy beverage
- Agribusiness

Use

- Conveyors
- Mixers
- Shredders
- Centrifuges
- Hot rotary dryers



Water & wastewater applications

- Treatment plant
- Wastewater treatment

Use

- Decanter



Cooling system with two separate air flows

General presentation of the offer

Altivar Process drives can help improve equipment performance and reduce operating costs by optimizing energy consumption and user comfort.

Altivar Process drives provide a wide range of integrated functions, such as:

- Safety and automation functions that meet the requirements of the most demanding applications
- Various optional fieldbus modules available for seamless integration into the main automation architectures
- Numerous configurable I/O as standard to facilitate adaptation to specific applications
- Intuitive commissioning using the graphic display terminal
- Local and remote access and monitoring using the embedded Web server
- Energy savings and protection of the grid by means of integrated harmonic filters
- Installation EMC conformity by means of integrated EMC filters

Depending on the power range, Altivar Process is available with several mounting types and protection indices:

- Wall-mounting IP 21/UL Type 1 from 0.75 kW/1 HP to 315 kW/500 HP, ready-to-use for easy integration inside or without an enclosure in an electrical room
- Wall-mounting IP 55 from 0.75 kW/1 HP to 90 kW/125 HP, ready-to-use for easy integration in a harsh environment or in an outdoor installation close to the system to reduce the length of the motor cable (the wall-mounting IP 55 offer is available with and without a disconnect switch)
- Floor-standing IP 21 and IP 54 from 110 to 315 kW, ready-to-use with minimum dimensions for easy, optimized integration in an electrical room in a standard or harsh environment

Floor-standing drives

The floor-standing IP 21/IP 54 drive offers integrate:

- The drive power and control modules
- Semiconductor protection fuses
- Line chokes to limit THDI levels
- A filter to help protect the motor against the effects of dv/dt
- Accessible busbars to simplify the motor wiring and power wiring

The IP 54 variant is fitted with additional equipment, such as:

- A main switch with external handle
- A system for separating the cooling air flow between the power and control parts, allowing operation in a very polluted environment as well as optimum management of thermal stress in the plant room

Altivar Process drives can also be supplied as Engineered Drive System variants from 110 kW to 800 kW, developed by Schneider Electric based on customer specifications.

Rugged

Altivar Process drives are designed to adapt to the harshest environments.

- Ambient operating temperature
 - Wall-mounting drives:
 - IP 21: - 15...+ 50 °C/+ 5...122 °F as standard
+ 50...60 °C/+ 122...140 °F with derating (1)
 - IP 55: - 15...+ 40 °C/+ 5...104 °F as standard
+ 40...50 °C/+ 104...122 °F with derating
 - a patented flange-mounting kit for evacuating the dissipated heat from the power section to outside the enclosure (see page 23)
 - Floor-standing IP 21/IP 54 drives:
 - 0...+ 40 °C/+ 32...104 °F as standard
 - + 40...50 °C/+ 104...122 °F with derating
- Storage and transport temperature: - 40...+ 70 °C/- 40...+ 158 °F (2)
- Operating altitude:
 - 0...1,000 m/0...3,281 ft without derating
 - 1,000...4,800 m/3,281...15,748 ft with derating of 1% per 100 m/328 ft
- Withstand to harsh environments:
 - Chemical class 3C3 conforming to IEC/EN 60721
 - Mechanical class 3S3 conforming to IEC/EN 60721
 - Electronic cards with protective coating
- Protection to suit requirements:
 - IP 21/UL type 1 for wall mounting in a plant room and in an enclosure
 - IP 55 for wall mounting, with protection against dust and water jets
 - Floor-standing IP 21
 - Floor-standing IP 54, with protection against dust and water jets

(1) For ATV930C22N4 and ATV930C22N4C...C31N4C drives, the ambient operating temperature range is - 10...+ 40 °C/+ 14...104 °F as standard and +40...60 °C/+ 104...140 °F with derating.

(2) For ATV930C22N4 and ATV930C22N4C...C31N4C drives, the storage and transport temperature range is - 25...+ 70 °C/- 13...+ 158 °F.

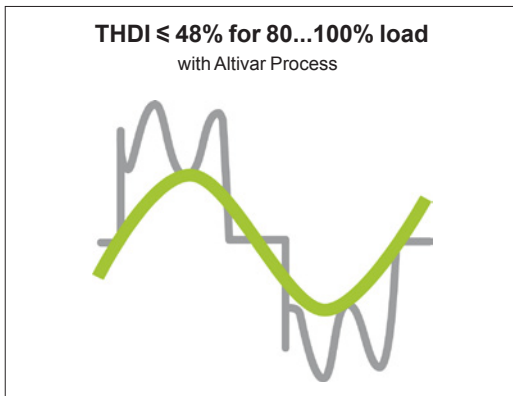

Altivar Process drive THDI

General presentation of the offer (continued)

Energy

Altivar Process drives help to optimize power consumption by reducing the rms input current for the same load.

- Standard offer:
 - THDI $\leq 48\%$ for 80 to 100% load, which is used to maintain an optimum power factor on the most common operating range
- Low harmonic offer compatible with standard IEEE 519

Environment

The Altivar Process drive has been developed to meet the requirements of directives regarding protection of the environment and anticipate future changes in regulations:

- RoHS-2 (1)
- REACh (2) + Solution for REACh Substitute It Now (halogen-free wiring and plastics)
- PEP (Product Environmental Profile) eco-passport Program for reducing the carbon footprint and conserving raw materials
- EoLI (End of Life Instruction) (3)
- More than 70% recyclable materials (new ruling)
- Efficient energy management: 30% reduction in consumption

Electromagnetic compatibility (EMC)

Compliance with electromagnetic compatibility requirements has been incorporated into the design of the drive, which simplifies installation and provides an economical means of helping to ensure equipment meets CE marking requirements.

Altivar Process drives have a category C2 or C3 EMC filter, except ATV930●●●M3 and ATV930●●●M3C models that can be equipped with an additional filter to meet more stringent requirements (see page 53).

Installation/Maintenance

Altivar Process drives are ergonomically designed to adapt to any type of installation:

- Products, systems, or integrated in iMCC
- IP 21, UL type 1; IP 55, IP 54
- Easy installation of products and systems:
 - Cable entry equipped with Romex cable clamps to maintain an EMC connection for the power and control cable
 - Color code for connections to the removable terminal blocks on the HMI block
 - Long cable: Up to 150 m with category C3 EMC filter, depending on model
- Asynchronous or synchronous motor in open loop or closed loop for 0.1...500 Hz output frequency
- Special motors: Conical sliding rotor, reluctance motor
- Lower maintenance costs due to drive's ergonomic design:
 - Fans can be replaced in less than 5 minutes
 - No maintenance tool required
 - Limited number of parts
- Embedded Web server:
 - Compatible process elements for easier implementation
 - Direct worldwide access to monitoring and maintenance functions:
 - Reading values
 - Modifying data
 - Configuring parameters
 - Changing controller status

(1) European directive 2002/95/EC Restriction Of Hazardous Substances (applicable in 2016)

(2) European regulation 1907/2006

(3) According to IEC 62635 Enhanced Guidelines

Integrated functions

Altivar Process drives include numerous advanced functions for the more complex applications in each market segment.

Advanced functions

- Performance on motor control with an overload torque up to 180% Tn in an open or closed loop
- Asynchronous, synchronous, special motors: all efficiency classes, brand independent, permanent magnet motors, torque motors, conical sliding rotor, reluctance
- Integrated EtherNet/IP and Modbus TCP dual port, cybersecurity (Achilles Level 2)
- Smart integration in PlantStruxure and Foxboro Evo process automation systems
- Optimized energy efficiency, detection of energy consumption drift of the installation
- Adaptation to the process by dedicated functions with modular design
- Embedded safety functions STO SIL3
- Master/slave and load sharing with drive-to-drive capability:
 - torque sharing on rigid coupling
 - torque sharing on elastic coupling
- Contextual access to technical documentation through dynamic QR code
- Continuous and historical real-time measurements with customizable dashboards
- Predictive maintenance (e.g.: temperatures with PT100/1000 probe, fan monitoring, etc.)

Power measurement function

Altivar Process drives integrate a power measurement function accurate to within 5%, based on measurement of the motor voltage and the power supply:

- Process drift detection for installation reliability throughout its entire service life
- Useful system performance information provided by comparing the energy used with the energy produced:
 - Typical KPIs:
 - Specific energy consumption

Users are therefore able to monitor and analyze input power, energy produced, and the KPIs directly from the drive or from the process management system.

Safety and monitoring functions

The Safety function STO and numerous monitoring functions are provided to help protect people and equipment.

- Advantages:
 - Time savings in terms of installation design and compliance
 - Fewer components and cables
 - Optimum space
 - Simplified setup of machines
 - Improved maintenance performance; limited machine intervention time and installation downtime
 - Optimized conditions for maintenance operations
- Conformity to standards EN/IEC 61508, EN/ISO 13849, IEC 61800-5-2
- Integrated STO (Safe Torque Off) function, SIL3/Plc
- Monitoring function to help protect against premature wear

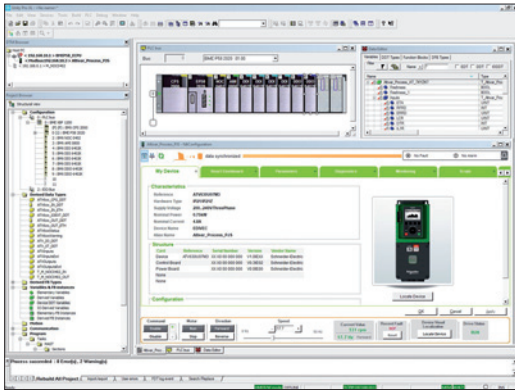

Altivar Process DTM in Unity Pro

Integration

Fieldbus protocols

- EtherNet/IP and Modbus/TCP Dual port and Modbus serial link:
 - Standard Modbus and Ethernet protocols
 - Connection of configuration and runtime tools
 - Control and supervision of the Altivar Process in process architectures (controllers, SCADA, HMIs, etc.) in industrial networks (read/write data)
 - Diagnostic, supervision, and fieldbus management functions
- Ethernet services:
 - SNMP, SNTP, BootP & DHCP, IP v6, cybersecurity services, FDR
 - Open Ethernet topologies

Integration of configuration and runtime tools

- FDT/DTM technology (see page 29):
 - Drive configuration, diagnostics, and control using Unity Pro or Foxboro Evo software

Configuration and runtime tools

- Graphic display terminal (see page 26):
 - Drive control, adjustment, and configuration
 - Display of current values (motor, I/O, etc.)
 - Configuration storage and download
 - Duplication of one drive configuration on another drive from a PC or another drive
 - Remote use by means of appropriate accessories (see page 27)
 - Connection to several drives using multidrop link components (see page 27)
- Embedded web server (see page 28):
 - Easily accessible from any PC, iPhone, iPad, Android system, and major web browsers
 - Network diagnostics in real time
 - Read/write values
- SoMove software (see page 29):
 - Advanced functions for configuration, setup, and maintenance of Altivar Process drives

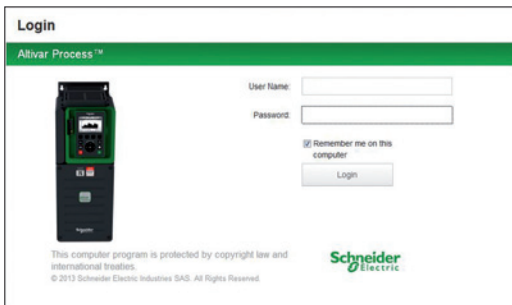

Embedded web server login screen

Integrated services

Altivar Process drives feature integrated services to achieve optimum time savings:

- Simplified communication:
 - Ethernet dual port with embedded web server
- Energy management (integrated power measurement)
- Dynamic predictive maintenance
- 3 QR codes:
 - 1: Access to the Customer Care Center application and product data sheet
 - 2: Direct access to description of the functions
 - 3: QR code generated in the event of a detected error (red screen): Identification of the detected error, probable causes and remedies



ATV930...N4F, ATV950...N4, ATV950...N4E, ATV930...M3

Extensive offer

The Altivar Process offer covers motor power ratings from 0.75...315 kW for three-phase voltages between 200...240 V and 380...480 V.

Three-phase power supply	Motor power	Degree of protection	Reference
200...240 V	0.75 kW...75 kW 1...100 HP	IP 21 UL type 1	ATV930U07M3...D45M3 ATV930D30M3C...D75M3C
380...480 V	0.75 kW...315 kW 1...500 HP	IP 21 UL type 1 IP 55	ATV930U07N4... C22N4 ATV930D55N4C...C31N4C ATV950U07N4...D90N4 ATV950U07N4E...D90N4E (1)
380...440 V	110 kW...315 kW	IP 21 IP 54	ATV930C11N4F...C31N4F ATV950C11N4F...C31N4F

(1) Integrated disconnect switch

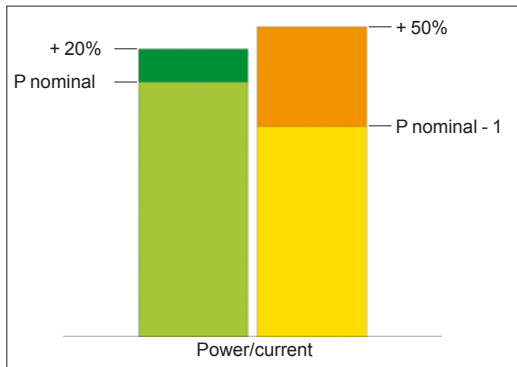

Normal duty and Heavy duty modes

Altivar Process variable speed drives are designed for use in two operating modes that can optimize the drive nominal rating according to the system constraints.

These two modes are:

- Normal duty (ND): Dedicated mode for applications requiring a slight overload (up to 120%) with a motor power no higher than the drive nominal power
- Heavy duty (HD): Dedicated mode for applications requiring a significant overload (up to 150%) with a motor power no higher than the drive nominal power derated by one rating

Accessories and options

Altivar Process drives are designed to take numerous accessories and options to increase their functionality and also their capacity for integration and adaptation.

Accessories

- Drive:
- Fan kit (see page 24)
- Graphic display terminal:
- Remote mounting kit for mounting on enclosure door (see page 27)
- Multidrop connection accessories for connecting several drives to the RJ45 terminal port (see page 27)

Options

- Modules (see page 35):
- I/O extension:
 - 2 analog inputs
 - 6 digital inputs
 - 2 digital outputs
- With relay output:
 - 3 NO contacts
- Communication:
 - CANopen bus: RJ45 daisy chain, SUB-D, 5-way screw terminals
 - PROFINET bus
 - Profibus DP V1 bus
 - EtherCAT
 - DeviceNet bus
- Encoder modules (see page 34):
- Digital interface encoder module 5/12 V
- Resolver interface module
- Analog interface encoder module
- Braking units and braking resistors (see page 42)
- Passive filters (see page 46)
- Additional EMC input filters for reducing conducted emissions on the line (see page 52)
- Output filters:
 - dv/dt filters (see page 54)
 - Sinus filters (see page 56)
 - Common mode filters (see page 58)

Motor starters

Schneider Electric offers combinations of circuit breakers and contactors to be able to use Altivar Process drives in optimum conditions (see page 60). For prospective line short circuit current up to 100 kA, please contact our Customer Care Center.



Engineered drive system based on the ATV960C50Q4X1 drive



Full ETO drive system

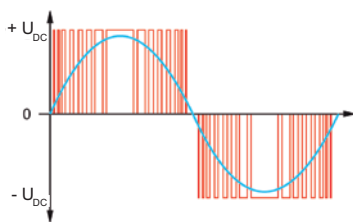

2-level technology

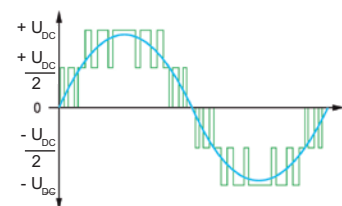

3-level technology

Engineered drive systems

Engineered drive systems from 0.75 to 1,200 kW based on the Altivar Process platform offer solutions ranging from compact enclosed systems to complex outdoor skids including third-party components or transformers, independent of the power range.

All engineered drive systems are fully tested and ready-to-connect drive solutions.

Several solutions are available depending on customer requirements.

Compact drive systems

Compact drive systems are enclosure units with a built-in variable speed drive to control the speed of asynchronous or synchronous motors. The modular construction makes it possible to adapt the enclosure unit to particular requirements.

Compact design

- Less space required in the control room
- Generous connection area for power cables
- Easy access to components
- Control panel for numerous options

The energy-saving drive solution

- Up to 60% energy savings without additional costs
- Intelligent control of internal fans, depending on the operation
- Optimal energy efficiency over the entire life cycle
- Logging and graphic presentation of absorbed power

Low harmonic drive systems

This new technology reaches a total harmonic distortion (THD(i)) of ~ 2%, and fulfills the requirements of the IEEE 519 standard for THD(i) < 5% in the event of distorted AC supply.

Extended motor lifetime with 3-level concept

The 3-level technology of the active mains rectifier reduces the voltage load at the motor significantly, compared to other low harmonic variable speed drives. The fluctuating adaptation of the DC link voltage helps extend the motor lifetime.

Reduced losses with 3-level concept

In comparison with the traditional circuit structure of active mains rectifiers, the switching frequency is increased and the current load is reduced at the same time when using 3-level technology.

Compact dimensions thanks to 3-level concept

A significant advantage of the 3-level technology is the reduced dimensions of the integrated filter components. Due to the increased switching frequency and to its location inside the forced cooling air channel, the dimensions of the filter can be almost halved.



People

- Worldwide network, 24/7:
- 400 highly qualified and certified experts
- Field service engineers, online experts

Engineered Drive Systems (continued)

Superior services

Our industry experts help you get the maximum return from your investments and optimize the value of your installations throughout their life cycle. Whether you need a brief telephone consultation, an on-site analysis, or the development of an entire system solution, our experts are at your disposal.

Audits and consultancy services

- From the selection of drives and accessories to the development of entire system solutions
- On-site analysis
- Line supply consultancy (compensation, filtering, harmonics, etc.)

Bespoke project management

- Measurement and analysis of your site
- Target definition
- Identification of opportunities to save energy and reduce costs
- Calculation of return on investment

Customized training

- Our experienced specialists offer training, either at our premises or at your site

Commissioning and on-site services

- Our specialists, experienced in a wide range of industrial sectors, leverage their extensive product and application knowledge to commission your systems

Digital services

- On-screen and event-specific QR codes help operators diagnose detected errors quickly
- Online troubleshooting with step-by-step procedures
- Track and analyze events related to your drive
- Automatic creation of technical support requests

For further information, please consult your local Schneider Electric drives expert.

Variable speed drives

Altivar Process ATV900

Three-phase supply voltage: 200...240 V 50/60 Hz



ATV930D11M3



ATV930D15M3



ATV930D30M3

IP 21/UL Type 1 drives - Wall mounting (1)										
Motor		Line supply				Altivar Process				
Power indicated on rating plate (2)		Line current (3)		Apparent power	Prospective line Isc	Maximum continuous current (2)	Maximum transient current for 60 s	Reference (1)	Weight	
		200 V	240 V							240 V
ND:	Normal duty (4)									
HD:	Heavy duty (5)									
	kW	HP	A	A	kVA	kA	A	A	kg/lb	
Three-phase supply voltage: 200...240 V 50/60 Hz										
ND	0.75	1	3	2.6	1.1	50	4.6	5.5	ATV930U07M3	4.300/9.480
HD	0.37	0.5	1.7	1.5	0.6	50	3.3	5		
ND	1.5	2	5.9	5	2.1	50	8	9.6	ATV930U15M3	4.300/9.480
HD	0.75	1	3.3	3	1.2	50	4.6	6.9		
ND	2.2	3	8.4	7.2	3	50	11.2	13.4	ATV930U22M3	4.500/9.921
HD	1.5	2	6	5.3	2.2	50	8	12		
ND	3	–	11.5	9.9	4.1	50	13.7	16.4	ATV930U30M3	4.500/9.921
HD	2.2	3	8.7	7.6	3.2	50	11.2	16.8		
ND	4	5	15.1	12.9	5.4	50	18.7	22.4	ATV930U40M3	4.600/10.141
HD	3	–	11.7	10.2	4.2	50	13.7	20.6		
ND	5.5	7.5	20.2	17.1	7.1	50	25.4	30.5	ATV930U55M3	7.700/16.976
HD	4	5	15.1	13	5.4	50	18.7	28.1		
ND	7.5	10	27.1	22.6	9.4	50	32.7	39.2	ATV930U75M3	13.800/30.424
HD	5.5	7.5	20.1	16.9	7	50	25.4	38.1		
ND	11	15	39.3	32.9	13.7	50	46.8	56.2	ATV930D11M3	13.800/30.424
HD	7.5	10	27.2	23.1	9.6	50	32.7	49.1		
ND	15	20	52.6	45.5	18.9	50	63.4	76.1	ATV930D15M3	27.300/60.186
HD	11	15	40.1	34.3	14.3	50	46.8	70.2		
ND	18.5	25	66.7	54.5	22.7	50	78.4	94.1	ATV930D18M3	27.300/60.186
HD	15	20	53.1	44.9	18.7	50	63.4	95.1		
ND	22	30	76.0	64.3	26.7	50	92.6	111.1	ATV930D22M3	27.300/60.186
HD	18.5	25	64.8	54.5	22.7	50	78.4	117.6		
ND	30	40	104.7	88.6	36.8	50	123	147.6	ATV930D30M3	57.600/126.986
HD	22	30	78.3	67.1	27.9	50	92.6	138.9		
ND	37	50	128.0	107.8	44.8	50	149	178.8	ATV930D37M3	57.600/126.986
HD	30	40	104.7	88.6	36.8	50	123	184.5		
ND	45	60	155.1	130.4	54.2	50	176	211.2	ATV930D45M3	57.600/126.986
HD	37	50	128.5	108.5	45.1	50	149	223.5		

IP 21/UL Type 1 drives without braking unit - Wall mounting (1)										
Motor		Line supply				Altivar Process				
Power indicated on rating plate (2)		Line current (3)		Apparent power	Prospective line Isc	Maximum continuous current (2)	Maximum transient current for 60 s	Reference (1)	Weight	
		200 V	240 V							240 V
ND:	Normal duty (4)									
HD:	Heavy duty (5)									
	kW	HP	A	A	kVA	kA	A	A	kg/lb	
Three-phase supply voltage: 200...240 V 50/60 Hz										
ND	30	40	104.7	88.6	36.8	50	123	147.6	ATV930D30M3C	56.600/124.782
HD	22	30	78.3	67.1	27.9	50	92.6	138.9		
ND	37	50	128.0	107.6	44.8	50	149	178.8	ATV930D37M3C	56.600/124.782
HD	30	40	104.7	88.6	36.8	50	123	184.5		
ND	45	60	155.1	130.4	54.2	50	175	211.2	ATV930D45M3C	56.600/124.782
HD	37	50	128.5	108.5	45.1	50	149	223.5		
ND	55	75	189	161	61.1	50	211	253.2	ATV930D55M3C	82.000/180.779
HD	45	60	156	134	50	50	176	264	(6)	
ND	75	100	256	215	83.7	50	282	338.4	ATV930D75M3C	82.000/180.779
HD	55	75	189	161	61.1	50	211	316.5	(6)	

- (1) Altivar Process **ATV930...M3** drives have been designed without an EMC filter. An additional filter can be added to help meet more stringent requirements and reduce electromagnetic emissions.
- (2) These values are given for a nominal switching frequency of 4 kHz up to **ATV930D22M3** or 2.5 kHz for **ATV930D30M3...D45M3** and **ATV930D30M3C...D75M3C**, for use in continuous operation. The switching frequency is adjustable. Above 2.5 or 4 kHz (depending on the rating), the drive will automatically reduce the switching frequency in the event of an excessive temperature rise. For continuous operation above the nominal switching frequency, derate the nominal drive current (see derating curves on our website www.schneider-electric.com).
- (3) Typical value for the indicated motor power and for the prospective line Isc.
- (4) Values given for applications requiring a slight overload (up to 120%).
- (5) Values given for applications requiring a significant overload (up to 150%).
- (6) The power parts are accessible at the bottom of the drive. Product supplied as IP 00 for mounting in an enclosure. For IP 21 wall mounting, order the IP 21/UL Type 1 conformity kit **VW3A9704** separately (see page 25).

Note: Consult the summary tables of possible drive, option, and accessory combinations (see page 30).

Presentation: page 8

Configuration and runtime tools: page 26

Combinations: page 30

Dimensions: page 66

Variable speed drives

Altivar Process ATV900

Three-phase supply voltage: 380...480 V 50/60 Hz



ATV930D15N4



ATV930D30N4



ATV930D55N4

IP 21/UL Type 1 drives with category C2 or C3 integrated EMC filter - Wall mounting ⁽¹⁾										
Motor		Line supply				Altivar Process				
Power indicated on rating plate ⁽²⁾		Line current ⁽³⁾		Apparent power	Prospective line Isc	Maximum continuous current ⁽²⁾	Maximum transient current for 60 s	Reference	Weight	
		380 V	480 V	380 V						
ND:	Normal duty ⁽⁴⁾									
HD:	Heavy duty ⁽⁵⁾									
kW	HP	A	A	kVA	kA	A	A		kg/lb	
Three-phase supply voltage: 380...480 V 50/60 Hz ⁽⁴⁾										
ND	0.75	1	1.5	1.3	1.1	50	2.2	2.6	ATV930U07N4	4.500/9.921
HD	0.37	0.5	0.9	0.8	0.7	50	1.5	2.3		
ND	1.5	2	3	2.6	2.2	50	4	4.8	ATV930U15N4	4.500/9.921
HD	0.75	1	1.7	1.5	1.2	50	2.2	3.3		
ND	2.2	3	4.3	3.8	3.2	50	5.6	6.7	ATV930U22N4	4.500/9.921
HD	1.5	2	3.1	2.9	2.4	50	4	6		
ND	3	–	5.8	5.1	4.2	50	7.2	8.6	ATV930U30N4	4.600/10.141
HD	2.2	3	4.5	4	3.3	50	5.6	8.4		
ND	4	5	7.6	6.7	5.6	50	9.3	11.2	ATV930U40N4	4.600/10.141
HD	3	–	6	5.4	4.5	50	7.2	10.8		
ND	5.5	7.5	10.4	9.1	7.6	50	12.7	15.2	ATV930U55N4	4.700/10.362
HD	4	5	8	7.2	6.0	50	9.3	14		
ND	7.5	10	13.8	11.9	9.9	50	16.5	19.8	ATV930U75N4	7.700/16.976
HD	5.5	7.5	10.5	9.2	7.6	50	12.7	19.1		
ND	11	15	19.8	17	14.1	50	23.5	28.2	ATV930D11N4	7.700/16.976
HD	7.5	10	14.1	12.5	10.4	50	16.5	24.8		
ND	15	20	27	23.3	19.4	50	31.7	38	ATV930D15N4	13.600/29.983
HD	11	15	20.6	18.1	15.0	50	23.5	35.3		
ND	18.5	25	33.4	28.9	24	50	39.2	47	ATV930D18N4	14.200/31.306
HD	15	20	27.7	24.4	20.3	50	31.7	47.6		
ND	22	30	39.6	34.4	28.6	50	46.3	55.6	ATV930D22N4	14.300/31.526
HD	18.5	25	34.1	29.9	24.9	50	39.2	58.8		
ND	30	40	53.3	45.9	38.2	50	61.5	73.8	ATV930D30N4	28.000/61.729
HD	22	30	40.5	35.8	29.8	50	46.3	69.5		
ND	37	50	66.2	57.3	47.6	50	74.5	89.4	ATV930D37N4	28.200/62.170
HD	30	40	54.8	48.3	40.2	50	61.5	92.3		
ND	45	60	79.8	69.1	57.4	50	88	105.6	ATV930D45N4	28.700/63.273
HD	37	50	67.1	59.0	49.1	50	74.5	111.8		
ND	55	75	97.2	84.2	70	50	106	127.2	ATV930D55N4	57.500/126.766
HD	45	60	81.4	71.8	59.7	50	88	132		
ND	75	100	131.3	112.7	93.7	50	145	174	ATV930D75N4	59.000/125.663
HD	55	75	98.9	86.9	72.2	50	106	159		
ND	90	125	156.2	135.8	112.9	50	173	207.6	ATV930D90N4	59.500/131.174
HD	75	100	134.3	118.1	98.2	50	145	217.5		
ND	220	350	397	324	247	50	427	512	ATV930C22N4	172.000/379.195
HD	160	250	296	246	187	50	302	453	(6)	

(1) Category C2 EMC filter for ATV930U07N4...D45N4. Category C3 EMC filter above ATV930D45N4.
 (2) These values are given for an adjustable nominal switching frequency of 4 kHz for ATV930U07N4...ATV930D45N4 or 2.5 kHz for ATV930D55N4...C22N4, for use in continuous operation.
 Above 2.5 or 4 kHz (depending on the rating), the drive will automatically reduce the switching frequency in the event of an excessive temperature rise. For continuous operation above the nominal switching frequency, derate the nominal drive current (see derating curves on our website www.schneider-electric.com).
 (3) Typical value for the indicated motor power and for the prospective line Isc.
 (4) Values given for applications requiring a slight overload (up to 120%).
 (5) Values given for applications requiring a significant overload (up to 150%).
 (6) Product supplied as IP 00 for mounting in an enclosure. For IP 21/UL Type 1 wall mounting, a conformity kit should be ordered separately (see page 25).

Note: Consult the summary tables of possible drive, option, and accessory combinations (see page 30).

Variable speed drives

Altivar Process ATV900

Three-phase supply voltage: 380...480 V, 380...440 V
50/60 Hz



ATV930C11N4C



ATV930C25N4C



ATV930C16N4F

IP 21/UL Type 1 drives with category C3 integrated EMC filter without braking unit - Wall mounting										
Motor	Line supply						Altivar Process		Reference	Weight
	Line current (2)		Apparent power	Prospective line Isc	Maximum continuous current (1)	Maximum transient current for 60 s				
	380 V	480 V					380 V			
ND: Normal duty (3)										
HD: Heavy duty (4)										
kW	HP	A	A	kVA	kA	A	A	kg/lb		
Three-phase supply voltage: 380...480 V 50/60 Hz (3)										
ND	55	75	97.2	84.2	70.0	50	106	127.2	ATV930D55N4C	56.500/124.561
HD	45	60	81.4	71.8	59.7	50	88	132		
ND	75	100	131.3	112.7	93.7	50	145	174.0	ATV930D75N4C	58.000/127.868
HD	55	75	98.9	86.9	72.2	50	106	159		
ND	90	125	156.2	135.8	112.9	50	173	207.6	ATV930D90N4C	58.500/128.970
HD	75	100	134.3	118.1	98.2	50	145	217.5		
ND	110	150	201	165	121.8	50	211	253	ATV930C11N4C	82.000/180.779
HD	90	125	170	143	102.6	50	173	259.5	(5)	
ND	132	200	237	213	161.4	50	250	300	ATV930C13N4C	82.000/180.779
HD	110	150	201	165	121.8	50	211	270	(5)	
ND	160	250	284	262	201.3	50	302	362	ATV930C16N4C	82.000/180.779
HD	132	200	237	213	161.4	50	250	360	(5)	
ND	220	350	397	324	247	50	427	512	ATV930C22N4C	172.000/319.195
HD	160	250	296	246	187	50	302	453	(5)	
ND	250	400	451	366	279	50	481	577	ATV930C25N4C	203.000/447.538
HD	200	300	365	301	229	50	387	581	(5)	
ND	315	500	569	461	351	50	616	739	ATV930C31N4C	203.000/447.538
HD	250	400	457	375	286	50	481	722	(5)	

IP 21 drives with category C3 integrated EMC filter - Floor standing (6)										
Motor	Line supply						Altivar Process		Reference	Weight
	Line current (2)		Apparent power	Maximum prospective line Isc	Maximum continuous current (1)	Maximum transient current for 60 s				
	380 V	400 V					380 V			
ND: Normal duty (3)										
HD: Heavy duty (4)										
kW	HP	A	A	kVA	kA	A	A	kg/lb		
Three-phase supply voltage: 380...440 V 50/60 Hz (3)										
ND	110	-	207	195	135	50	211	253	ATV930C11N4F	300.000/661.386
HD	90	-	174	164	113	50	173	260		
ND	132	-	250	232	161	50	250	300	ATV930C13N4F	300.000/661.386
HD	110	-	207	197	136	50	211	317		
ND	160	-	291	277	192	50	302	362	ATV930C16N4F	300.000/661.386
HD	132	-	244	232	161	50	250	375		
ND	200	-	369	349	242	50	370	444	ATV930C20N4F	400.000/881.848
HD	160	-	302	286	198	50	302	453		
ND	250	-	453	432	299	50	477	572	ATV930C25N4F	400.000/881.848
HD	200	-	369	353	244	50	370	555		
ND	315	-	566	538	373	50	590	708	ATV930C31N4F	400.000/881.848
HD	250	-	453	432	299	50	477	716		

(1) These values are given for a nominal switching frequency of 2.5 kHz for use in continuous operation. The switching frequency is adjustable for all ratings. Above 2.5 kHz, the drive will automatically reduce the switching frequency in the event of an excessive temperature rise. For continuous operation above the nominal switching frequency, derate the nominal drive current (see derating curves on our website www.schneider-electric.com).

(2) Typical value for the indicated motor power and for the maximum prospective line Isc.

(3) Values given for applications requiring a slight overload (up to 120%).

(4) Values given for applications requiring a significant overload (up to 150%).

(5) Product supplied as IP 00 for mounting in an enclosure. For IP 21/UL Type 1 wall mounting, a conformity kit should be ordered separately (see page 25).

(6) Integrated motor chokes allowing a shielded motor cable length up to 300 m/984 ft in category C3 and an unshielded cable length up to 450 m/1,476 ft in category C4.

Note: Consult the summary tables of possible drive, option, and accessory combinations (see page 30).



ATV950D15N4



ATV950D30N4



ATV950D55N4

IP 55 drives with category C2 or C3 integrated EMC filter - Wall mounting (1)										
Motor	Line supply						Altivar Process			
Power indicated on rating plate (2)	Line current (3)		Apparent power	Prospective line Isc	Maximum continuous current (2)	Maximum transient current for 60 s	Reference (6)	Weight		
	380 V	480 V							380 V	
ND: Normal duty (4)										
HD: Heavy duty (5)										
	kW	HP	A	A	kVA	kA	A	A		kg/lb
Three-phase supply voltage: 380...480 V 50/60 Hz (4)										
ND	0.75	1	1.5	1.3	1.1	50	2.2	2.6	ATV950U07N4	10.500/23.149
HD	0.37	0.5	0.9	0.8	0.7	50	1.5	2.3		
ND	1.5	2	3	2.6	2.2	50	4	4.8	ATV950U15N4	10.500/23.149
HD	0.75	1	1.7	1.5	1.2	50	2.2	3.3		
ND	2.2	3	4.3	3.8	3.2	50	5.6	6.7	ATV950U22N4	10.500/23.149
HD	1.5	2	3.1	2.9	2.4	50	4	6		
ND	3	–	5.8	5.1	4.2	50	7.2	8.6	ATV950U30N4	10.600/23.369
HD	2.2	3	4.5	4	3.3	50	5.6	8.4		
ND	4	5	7.6	6.7	5.6	50	9.3	11.2	ATV950U40N4	10.600/23.369
HD	3	–	6	5.4	4.5	50	7.2	10.8		
ND	5.5	7.5	10.4	9.1	7.6	50	12.7	15.2	ATV950U55N4	10.700/23.589
HD	4	5	8	7.2	6.0	50	9.3	14		
ND	7.5	10	13.8	11.9	9.9	50	16.5	19.8	ATV950U75N4	13.700/30.203
HD	5.5	7.5	10.5	9.2	7.6	50	12.7	19.1		
ND	11	15	19.8	17	14.1	50	23.5	28.2	ATV950D11N4	13.700/30.203
HD	7.5	10	14.1	12.5	10.4	50	16.5	24.8		
ND	15	20	27	23.3	19.4	50	31.7	38	ATV950D15N4	19.600/43.211
HD	11	15	20.6	18.1	15	50	23.5	35.3		
ND	18.5	25	33.4	28.9	24	50	39.2	47	ATV950D18N4	20.600/45.415
HD	15	20	27.7	24.4	20.3	50	31.7	47.6		
ND	22	30	39.6	34.4	28.6	50	46.3	55.6	ATV950D22N4	20.600/45.415
HD	18.5	25	34.1	29.9	24.9	50	39.2	58.8		
ND	30	40	53.3	45.9	38.2	50	61.5	73.8	ATV950D30N4	50.000/110.231
HD	22	30	40.5	35.8	29.8	50	46.3	69.5		
ND	37	50	66.2	57.3	47.6	50	74.5	89.4	ATV950D37N4	50.000/110.231
HD	30	40	54.8	48.3	40.2	50	61.5	92.3		
ND	45	60	79.8	69.1	57.4	50	88	105.6	ATV950D45N4	50.000/110.231
HD	37	50	67.1	59	49.1	50	74.5	111.8		
ND	55	75	97.2	84.2	70	50	106	127.2	ATV950D55N4	87.000/191.802
HD	45	60	81.4	71.8	59.7	50	88	132		
ND	75	100	131.3	112.7	93.7	50	145	174	ATV950D75N4	87.000/191.802
HD	55	75	98.9	86.9	72.2	50	106	159		
ND	90	125	156.2	135.8	112.9	50	173	207.6	ATV950D90N4	87.700/193.345
HD	75	100	134.3	118.1	98.2	50	145	217.5		

(1) Category C2 EMC filter for ATV950U07N4...D45N4. Category C3 EMC filter above ATV950D45N4.

(2) These values are given for an adjustable nominal switching frequency of 4 kHz up to ATV950D45N4 or 2.5 kHz for ATV950D55N4...D90N4, for use in continuous operation.

Above 2.5 or 4 kHz (depending on the rating), the drive will automatically reduce the switching frequency in the event of an excessive temperature rise. For continuous operation above the nominal switching frequency, derate the nominal drive current, see derating curves on our website www.schneider-electric.com.

(3) Typical value for the indicated motor power and for the prospective line Isc.

(4) Values given for applications requiring a slight overload (up to 120%).

(5) Values given for applications requiring a significant overload (up to 150%).

(6) Supplied with cable gland.

Note: Consult the summary tables of possible drive, option and accessory combinations (see page 30).

Variable speed drives

Altivar Process ATV900

Three-phase supply voltage: 380...480 V 50/60 Hz



ATV950D15N4E



ATV950D30N4E



ATV950D55N4E

IP 55 drives with Vario disconnect switch and category C2 or C3 integrated EMC filter - Wall mounting (1)										
Motor	Line supply						Altivar Process			
	Power indicated on rating plate (2)		Line current (3)		Apparent power	Prospective line Isc	Maximum continuous current (2)	Maximum transient current for 60 s	Reference (6)	Weight
ND:	HP	380 V	480 V	380 V	A					
HD:	HP			kVA	kA					
Three-phase supply voltage: 380...480 V 50/60 Hz (4)										
ND	0.75	1	1.5	1.3	1.1	50	2.2	2.6	ATV950U07N4E	10.500/ 23.149
HD	0.37	0.5	0.9	0.8	0.7	50	1.5	2.3		
ND	1.5	2	3	2.6	2.2	50	4	4.8	ATV950U15N4E	10.500/ 23.149
HD	0.75	1	1.7	1.5	1.2	50	2.2	3.3		
ND	2.2	3	4.3	3.8	3.2	50	5.6	6.7	ATV950U22N4E	10.500/ 23.149
HD	1.5	2	3.1	2.9	2.4	50	4	6		
ND	3	-	5.8	5.1	4.2	50	7.2	8.6	ATV950U30N4E	10.600/ 23.369
HD	2.2	3	4.5	4	3.3	50	5.6	8.4		
ND	4	5	7.6	6.7	5.6	50	9.3	11.2	ATV950U40N4E	10.600/ 23.369
HD	3	-	6	5.4	4.5	50	7.2	10.8		
ND	5.5	7.5	10.4	9.1	7.6	50	12.7	15.2	ATV950U55N4E	10.700/ 23.589
HD	4	5	8	7.2	6.0	50	9.3	14		
ND	7.5	10	13.8	11.9	9.9	50	16.5	19.8	ATV950U75N4E	13.700/ 30.203
HD	5.5	7.5	10.5	9.2	7.6	50	12.7	19.1		
ND	11	15	19.8	17	14.1	50	23.5	28.2	ATV950D11N4E	13.700/ 30.203
HD	7.5	10	14.1	12.5	10.4	50	16.5	24.8		
ND	15	20	27	23.3	19.4	50	31.7	38	ATV950D15N4E	19.600/ 43.211
HD	11	15	20.6	18.1	15	50	23.5	35.3		
ND	18.5	25	33.4	28.9	24	50	39.2	47	ATV950D18N4E	20.600/ 45.415
HD	15	20	27.7	24.4	20.3	50	31.7	47.6		
ND	22	30	39.6	34.4	28.6	50	46.3	55.6	ATV950D22N4E	20.600/ 45.415
HD	18.5	25	34.1	29.9	24.9	50	39.2	58.8		
ND	30	40	53.3	45.9	38.2	50	61.5	73.8	ATV950D30N4E	52.000/ 114.640
HD	22	30	40.5	35.8	29.8	50	46.3	69.5		
ND	37	50	66.2	57.3	47.6	50	74.5	89.4	ATV950D37N4E	52.000/ 114.640
HD	30	40	54.8	48.3	40.2	50	61.5	92.3		
ND	45	60	79.8	69.1	57.4	50	88	105.6	ATV950D45N4E	52.000/ 114.640
HD	37	50	67.1	59	49.1	50	74.5	111.8		
ND	55	75	97.2	84.2	70	50	106	127.2	ATV950D55N4E	89.300/ 196.873
HD	45	60	81.4	71.8	59.7	50	88	132		
ND	75	100	131.3	112.7	93.7	50	145	174	ATV950D75N4E	89.300/ 196.872
HD	55	75	98.9	86.9	72.2	50	106	159		
ND	90	125	156.2	135.8	112.9	50	173	207.6	ATV950D90N4E	90.000/ 198.416
HD	75	100	134.3	118.1	98.2	50	145	217.5		

(1) Category C2 EMC filter for ATV950U07N4E...D45N4E. Category C3 EMC filter above ATV950D45N4E.

(2) These values are given for an adjustable nominal switching frequency of 4 kHz up to ATV950D45N4E or 2.5 kHz for ATV950D55N4E...D90N4E, for use in continuous operation.

Above 2.5 or 4 kHz (depending on the rating), the drive will automatically reduce the switching frequency in the event of an excessive temperature rise. For continuous operation above the nominal switching frequency, derate the nominal drive current (see derating curves on our website www.schneider-electric.com).

(3) Typical value for the indicated motor power and for the prospective line Isc.

(4) Values given for applications requiring a slight overload (up to 120%).

(5) Values given for applications requiring a significant overload (up to 150%).

(6) Supplied with cable gland.

Note: Consult the summary tables of possible drive, option, and accessory combinations (see page 30).

PF151221



ATV950C31N4F

IP 54 drives with switch and category C3 integrated EMC filter - Floor standing ⁽¹⁾										
Motor			Line supply				Altivar Process			
Power indicated on rating plate			Line current ⁽²⁾		Apparent power	Maximum prospective line Isc	Maximum continuous current	Maximum transient current for 60 s	Reference	Weight
			380 V	400 V						
ND:	Normal duty ⁽³⁾									
HD:	Heavy duty ⁽⁴⁾									
	kW	HP	A	A	kVA	kA	A	A		kg/lb
Three-phase supply voltage: 380...440 V 50/60 Hz ⁽³⁾										
ND	110	–	207	195	135	50	211	253	ATV950C11N4F	310.000/ 683.433
HD	90	–	174	164	113	50	173	260		
ND	132	–	250	232	161	50	250	300	ATV950C13N4F	310.000/ 683.433
HD	110	–	207	197	136	50	211	317		
ND	160	–	291	277	192	50	302	362	ATV950C16N4F	310.000/ 683.433
HD	132	–	244	232	161	50	250	375		
ND	200	–	369	349	242	50	370	444	ATV950C20N4F	420.000/ 925.941
HD	160	–	302	286	198	50	302	453		
ND	250	–	453	432	299	50	477	572	ATV950C25N4F	420.000/ 925.941
HD	200	–	369	353	244	50	370	555		
ND	315	–	566	538	373	50	590	708	ATV950C31N4F	420.000/ 925.941
HD	250	–	453	432	299	50	477	716		

(1) Integrated motor chokes allowing a shielded motor cable length up to 300 m/984 ft in category C3 and an unshielded cable length up to 450 m/1,476 ft in category C4.

(2) Typical value for the indicated motor power and for the maximum prospective line Isc.

(3) Values given for applications requiring a slight overload (up to 120%).

(4) Values given for applications requiring a significant overload (up to 150%).

Note: Consult the summary tables of possible drive, option, and accessory combinations (see page 30).

Replacement parts			
Description	For drive	Reference	Weight kg/lb
Fan kit for wall-mounting drives			
Power fan for IP 21 and IP 55 drives, bracket, instruction sheets	ATV930U07M3...U40M3, ATV930U07N4...U55N4, ATV950U07N4...U55N4, ATV950U07N4E...U55N4E	VX5VPS1001	–
	ATV930U55M3, ATV930U75N4...D11N4, ATV950U75N4...D11N4, ATV950U75N4E...D11N4E	VX5VPS2001	–
	ATV930U75M3...D11M3, ATV930D15N4...D22N4, ATV950D15N4...D22N4, ATV950D15N4E...D22N4E	VX5VPS3001	–
	ATV930D15M3...D22M3, ATV930D30N4...D45N4, ATV950D30N4...D45N4, ATV950D30N4E...D45N4E	VX5VPS4001	–
	ATV930D30M3...D45M3, ATV930D30M3C...D45M3C, ATV930D55N4...D90N4, ATV950D55N4...D90N4, ATV950D55N4E...D90N4E	VX5VPS5001	–
	ATV930D55M3C...D75M3C, ATV930C11N4C...C16N4C	VX5VPS6001	–
Control fan for IP 55 drives, bracket, instruction sheets	ATV950U07N4...D22N4, ATV950U07N4E...D22N4E	VX5VP50A001	–
	ATV950D30N4...D90N4, ATV950D30N4E...D90N4E	VX5VP50BC001	–
Fan kit for floor-standing drives			
Power fan, bracket, instruction sheets	ATV930C11N4F...C31N4F, ATV950C11N4F...C31N4F	VX5VPM001	–
Door fan, bracket, instruction sheets	ATV930C11N4F...C31N4F, ATV950C11N4F...C31N4F	VX5VPM002	–
Enclosure grid filter pads			
223 x 223 mm/8.78 x 8.78 in. enclosure grid filter pad	ATV950C11N4F...C16N4F	NSYCAF223	–
291 x 291 mm/11.46 x 11.46 in. enclosure grid filter pad	ATV950C20N4F...C31N4F	NSYCAF291	–

Accessories for flange-mounting					
Description	For use with	Enclosure max. height (mm/in.)	Enclosure max. width (mm/in.)	Reference	Weight kg/lb
Mounting bracket for flange-mounting kit	NSYPTDS1, NSYPTDS2, NSYPTDS3	–	–	NSYAEFPFPTD	–
Flange-mounting kit for separate air flow (1)	ATV930U07M3...U40M3, ATV930U07N4...U55N4	360/14.17	235/9.25	NSYPTDS1	–
	ATV930U55M3, ATV930U75N4...D11N4	420/16.54	265/10.43	NSYPTDS2	–
	ATV930U75M3...D11M3, ATV930D15N4...D22N4	555/2.85	295/11.61	NSYPTDS3	–
	ATV930D15M3...D22M3, ATV930D30N4...D45N4	800/31.50	385/15.16	NSYPTDS4	–
	ATV930D30M3...D45M3, ATV930D30M3C...D45M3C, ATV930D55N4...D90N4, ATV930D55N4C...D90N4C	975/38.39	427/16.81	NSYPTDS5	–

IP 21/UL Type 1 conformity kits				
Description	For use with	Use with braking unit	Reference	Weight kg/lb
IP 21/UL Type 1 conformity kit	ATV930D55M3C...D75M3C, ATV930C11N4C...C16N4C	–	VW3A9704	–
UL Type 1 conformity kit	ATV930C22N4, ATV930C22N4C	–	VW3A9212	–
	ATV930C25N4C, ATV930C31N4C	Without braking unit	VW3A9213	–
		With braking unit	VW3A9214	–
IP 21 conformity kit	ATV930C22N4, ATV930C22N4C	–	VW3A9112	–
	ATV930C25N4C, ATV930C31N4C	Without braking unit	VW3A9113	–
		With braking unit	VW3A9114	–

(1) RUE-2192 patented system.



Graphic display terminal
(example shows dynamic speed and torque)



Detected fault: The screen's red backlight
is activated automatically



Embedded dynamic QR codes for contextual,
instantaneous access to online help



Scanning the QR code from a smartphone
or tablet

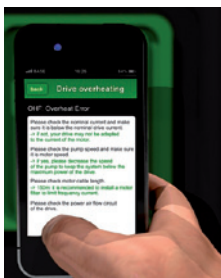

Instant access to online help

Graphic display terminal (supplied with the drive)

This terminal can be:

- Connected and mounted on the front of the drive
- Connected and mounted on an enclosure door using a remote mounting accessory
- Connected to a PC to exchange files via a Mini USB/USB connection (1)
- Connected to several drives in multidrop mode (see page 27)

This terminal is used to:

- Control, adjust, and configure the drive
- Display current values (motor, I/O, and process data)
- Display graphic dashboards such as the energy consumption monitoring dashboard
- Store and download configurations (several configuration files can be stored in the 16 MB memory)
- Duplicate the configuration of one powered-up drive on another powered-up drive
- Copy configurations from a PC or drive and duplicate them on another drive (the drives must be powered on for the duration of the duplication operations)

Other characteristics:

- 24 integrated languages (complete alphabets) covering the majority of countries around the world (other languages can be added; please consult our website www.schneider-electric.com)
- 2-color backlit display (white and red); if an error is detected, the red backlight is activated automatically (function can be disabled)
- Operating range: -15...50 °C/+5...122 °F
- Degree of protection: IP 65
- Trend curves: Graphic display of changes over time in monitoring variables, energy data, and process data
- Embedded dynamic QR codes for contextual, instantaneous access to online help (diagnostics and settings, etc.) using a smartphone or tablet
- Real-time clock with 10-year backup battery providing data acquisition and event timestamping functions even when the drive is stopped

Description

Display:

- 8 lines, 240 x 160 pixels
- Displays bar charts, gauges, and trend charts
- 4 function keys to facilitate navigation and provide contextual links for enabling functions
- "STOP/RESET" button: Local control of motor stop command/clearing detected errors
- "RUN" button: Local control of motor run command
- Navigation buttons:
 - OK button: Saves the current value (ENT)
 - Turn ±: Increases or decreases the value, goes to the next or previous line
 - "ESC" button: Aborts a value, parameter, or menu to return to the previous selection
 - Home: Root menu
 - Information (i): Contextual help

References

Description	Reference	Weight kg/ lb
Graphic display terminal	VW3A1111	0.200/ 0.441

Communication accessory

Description	Reference	Weight kg/ lb
IP 20 WiFi dongle remote mounting of the Ethernet port for connection of WiFi equipment (PC, tablet, smartphone, etc.) powered by internal rechargeable battery	TCSEGWB13FA0	0.350/ 0.772

(1) Graphic display terminal used only as a handheld terminal.

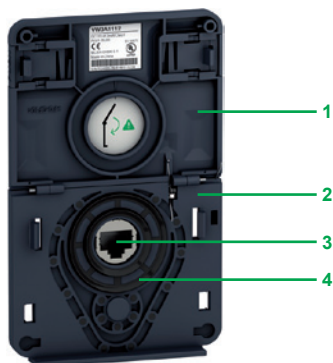

Remote mounting kit for mounting graphic display terminal on enclosure door (front panel)

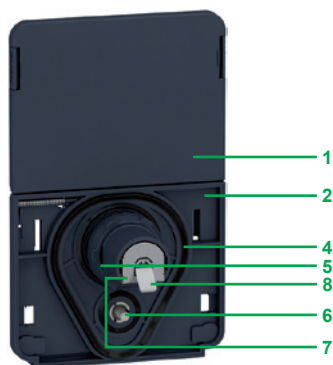

Remote mounting kit for graphic display terminal (rear panel)

Accessories for graphic display terminal

■ Remote mounting kit for mounting on enclosure door with IP 65 degree of protection as standard

The kit comprises:

- Tightening tool (also sold separately under the reference ZB5AZ905)

- 1 Cover plate to maintain IP 65 protection when there is no terminal connected
- 2 Mounting plate
- 3 RJ45 port for the graphic display terminal
- 4 Seal
- 5 Fixing nut
- 6 Anti-rotation pin
- 7 RJ45 port for connecting the remote-mounting cordset (10 m/32.81 ft maximum)
Cordsets should be ordered separately depending on the length required
- 8 Grounding connector

Drilling a hole with a standard $\varnothing 22$ tool, as used for a pushbutton, allows the unit to be mounted without needing a cut-out in the enclosure ($\varnothing 22.5$ mm/ $\varnothing 0.89$ in. drill hole).

References

Description	Length m/ ft	IP	Reference	Weight kg/ lb
Remote mounting kit Order with remote-mounting cordset VW3A1104R●●●	–	65	VW3A1112	–
Tightening tool for remote mounting kit	–	–	ZB5AZ905	0.016/ 0.035
Remote-mounting cordset equipped with 2 RJ45 connectors	1/ 3.28 3/ 9.84 5/ 16.40 10/ 32.81	–	VW3A1104R10 VW3A1104R30 VW3A1104R50 VW3A1104R100	0.050/ 0.110 0.150/ 0.331 0.250/ 0.551 0.500/ 1.102
USB/Mini B USB cable for connecting the display terminal to a PC	–	–	TCSXCNAMUM3P	–
IP 65 remote mounting kit for Ethernet (1) $\varnothing 22$ RJ45 female/female adapter with seal	–	65	VW3A1115	0.200/ 0.441

Multidrop connection accessories

These accessories are used to connect a graphic display terminal to several drives via a multidrop link. This multidrop connection uses the RJ45 terminal port on the front of the drive.

Connection accessories

Description	Sold in lots of	Unit reference	Weight kg/ lb
Modbus splitter box 10 RJ45 connectors and 1 screw terminal block	–	LU9GC3	0.500/ 1.102
Modbus T-junction boxes			
With 0.3 m/0.98 ft integrated cable	–	VW3A8306TF03	0.190/ 0.419
With 1 m/3.28 ft integrated cable	–	VW3A8306TF10	0.210/ 0.463
Modbus line terminator			
For RJ45 connector	R = 120 Ω C = 1 nf	2 VW3A8306RC	0.010/ 0.022

Cordsets (equipped with 2 RJ45 connectors)

Used for	Length m/ ft	Reference	Weight kg/ lb
Serial link	0.3/ 0.98	VW3A8306R03	0.025/ 0.055
	1/ 3.28	VW3A8306R10	0.060/ 0.132
	3/ 9.84	VW3A8306R30	0.130/ 0.287

(1) Used to connect a remote PC to the RJ45 port on an IP 21 drive mounted in an enclosure or on a wall. Drill hole with a standard $\varnothing 22$ tool, as used for a pushbutton. (Requires a remote-mounting cordset VW3A1104R●●● equipped with 2 RJ45 connectors).

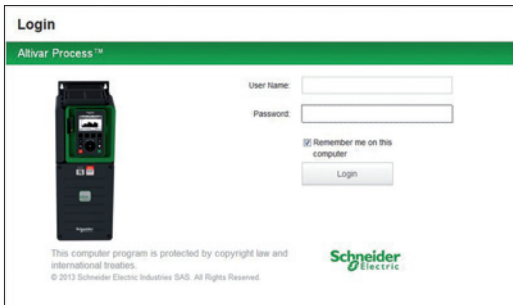

Login screen

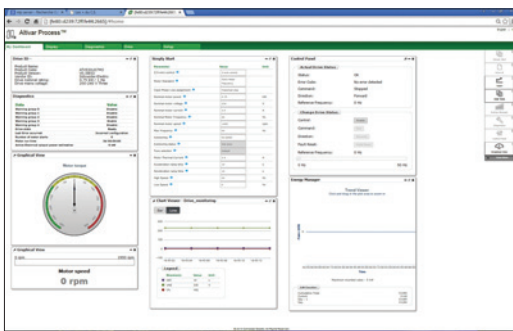

Customizable widgets

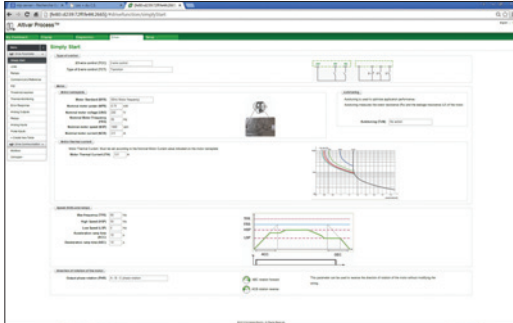

Drive adjustment parameters

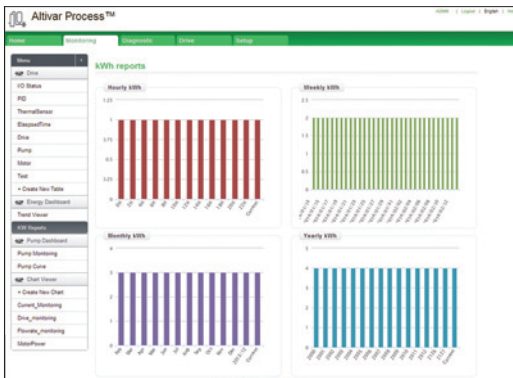

Energy dashboard

Web server

Presentation

- The Web server can be accessed:
 - For a drive not connected to an Ethernet network
 - Via an Ethernet cable or the Schneider Electric WiFi dongle (the drive then appears as a network device)
 - For a drive connected to an Ethernet network
 - From any point on the network by entering the drive IP address
- The Web server is used for:
 - Commissioning the drive (setting configuration parameters and enabling the main functions)
 - Monitoring energy and process data, as well as drive and motor data
 - Diagnostics (drive status, file transfer, detected error and warning logs)

Description

The Web server is structured around 5 tabs.

- “My dashboard” tab:
 - Configurable using a wide choice of widgets; groups all the information and dashboards selected by the user on one page
- “Display” tab:
 - Monitors energy indicators, efficiency, and performance
 - Displays process data
 - Monitors drive parameters and status
 - Shows the I/O state and assignment
- “Diagnostics” tab:
 - Drive status
 - Time and date-stamped warning and detected error logs
 - Network diagnostics
 - Access to drive self-tests
- “Drive” tab:
 - Access to the main drive adjustment parameters with contextual help
- “Setup” tab:
 - Network configuration
 - Access management
 - Transferring and retrieving drive configurations
 - Exporting data acquisition files and logs
 - Customizing pages (colors, logos, etc.)

Other characteristics:

- Ease of connection via the RJ45 port or WiFi connection
- Password-protected authentication (modifiable password; access rights can be configured by administrator)
- No downloads or installation necessary
- Web server can be disabled
- Works in a similar way on PCs, iPhones, iPads, Android systems, and the following major web browsers:
 - Internet Explorer® (version 8 or higher)
 - Google Chrome® (version 11 or higher)
 - Mozilla Firefox® (version 4 or higher)
 - Safari® (version 5.1.7 or higher)

DTM

Presentation

Using FDT/DTM technology it is possible to configure, control, and diagnose Altivar Process drives directly in Unity Pro and SoMove software by means of the same software brick (DTM).

FDT/DTM technology standardizes the communication interface between field devices and host systems. The DTM contains a uniform structure for managing drive access parameters.

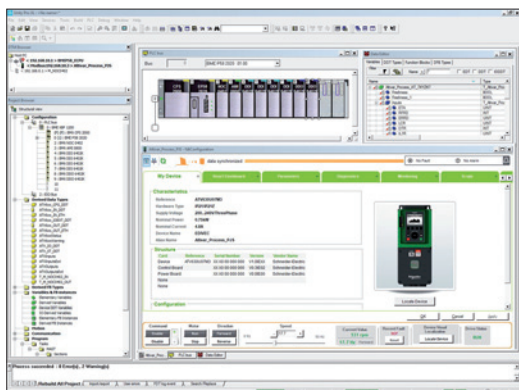

Altivar Process DTM in Unity

Specific functions of the Altivar Process DTM

- Offline or online access to drive data
- Drive firmware updates
- Transfer of configuration files from and to the drive
- Customization (dashboard, My Menu, etc.)
- Access to drive parameters and option cards
- Oscilloscope function
- Graphic interface to assist with configuration of the Altivar Process functions
- Energy and process dashboards
- Graphic display of system operation and comparison with optimum operation (dynamic speed and torque curves)
- Detected error and warning logs (with timestamping)

Advantages of the DTM library in Unity Pro:

- Single tool for configuration, setup, and diagnostics
- Network scan for automatic recognition of network configuration
- Ability to add/remove, copy/paste configuration files from other drives in the same architecture
- Single input point for all parameters shared between the ePAC (programmable controller) and the Altivar Process drive
- Creation of drive profiles for implicit communication with the ePAC as well as dedicated profiles for programs with DFBs (derived function blocks)
- Integration in the fieldbus topology
- Drive configuration is an integral part of the Unity Pro project file (STU) and the archive file (STA)

Advantages of the DTM library in SoMove:

- Drive-oriented software environment
- Wired connection to the Ethernet communication port
- Standard cable (file transfer performance)
- Function block library for Unity Pro
- Display blocks for Vijeo Citect

■ Third-party software and downloads:

The Altivar Process DTM library is a flexible, open, and interactive tool that can be used in a third-party FDT.

DTMs can be downloaded from our website www.schneider-electric.com.

SoMove software

Presentation

SoMove software for PC is used to configure, set up, and maintain Altivar Process drives.

In addition to the functions offered by the Web server, SoMove software features the oscilloscope function for accurate display of data samples, as well as access to multi-drive applications.

The software can be connected to Altivar Process variable speed drives via:

- A Bluetooth® wireless connection with the Bluetooth/Modbus adapter TCSWAAC13FB
- Ethernet Modbus and WiFi connection with the WiFi dongle TCSEGWB13FA0
- Ethernet Modbus TCP connection

For more information on SoMove setup software, please consult the “SoMove: Setup Software” catalog available on our website www.schneider-electric.com.



SoMove software

Table showing possible combinations of options for ATV930●●●M3/M3C, ATV930●●●N4/N4C drives																
Motor	Drive	Accessories			Options				EMC filters	IP 21 kit for EMC filter	dv/dt filters	IP 21 kit for dv/dt filter	Sinus filter	IP 21 kit for sinus filter	Common mode filters (2)	
		Flange-mounting kit	UL Type 1 conformity kit	IP 21 conformity kit	Passive filters (50 Hz)		Passive filters (60 Hz)									
kW	HP				THDI < 10%	THDI < 5%	THDI < 10%	THDI < 5%								
Three-phase supply voltage: 200...240 V 50/60 Hz - IP 21/UL Type 1																
0.75	1	ATV930U07M3	NSYPTDS1	–	–	–	–	–		VW3A4701	VW3A47901	VW3A5301	VW3A53902	VW3A5401	VW3A53901	VW3A5502
1.5	2	ATV930U15M3	NSYPTDS1	–	–	–	–	–		VW3A4701	VW3A47901	VW3A5302	VW3A53902	VW3A5402	VW3A53901	VW3A5502
2.2	3	ATV930U22M3	NSYPTDS1	–	–	–	–	–		VW3A4702	VW3A47902	VW3A5302	VW3A53902	VW3A5402	VW3A53901	VW3A5502
3	–	ATV930U30M3	NSYPTDS1	–	–	–	–	–		VW3A4702	VW3A47902	VW3A5302	VW3A53902	VW3A5402	VW3A53901	VW3A5502
4	5	ATV930U40M3	NSYPTDS1	–	–	–	–	–		VW3A4703	VW3A47903	VW3A5303	VW3A53902	VW3A5403	VW3A53902	VW3A5502
5.5	7.5	ATV930U55M3	NSYPTDS2	–	–	–	–	–		VW3A4703	VW3A47903	VW3A5304	VW3A53903	VW3A5404	VW3A53903	VW3A5502
7.5	10	ATV930U75M3	NSYPTDS3	–	–	–	–	–		VW3A4703	VW3A47903	VW3A5304	VW3A53903	VW3A5404	VW3A53903	VW3A5504
11	15	ATV930D11M3	NSYPTDS3	–	–	–	–	–		VW3A4704	VW3A47904	VW3A5304	VW3A53903	VW3A5404	VW3A53903	VW3A5504
15	20	ATV930D15M3	NSYPTDS4	–	–	–	–	–		VW3A4705	VW3A47905	VW3A5305	VW3A53905	VW3A5405	VW3A53904	VW3A5504
18.5	25	ATV930D18M3	NSYPTDS4	–	–	–	–	–		VW3A4706	VW3A47906	VW3A5305	VW3A53905	VW3A5405	VW3A53904	VW3A5504
22	30	ATV930D22M3	NSYPTDS4	–	–	–	–	–		VW3A4706	VW3A47906	VW3A5305	VW3A53905	VW3A5405	VW3A53904	VW3A5504
30	40	ATV930D30M3	NSYPTDS5	–	–	–	–	–		VW3A4707	VW3A47907	VW3A5306	–	VW3A5406	–	VW3A5504
37	50	ATV930D37M3	NSYPTDS5	–	–	–	–	–		VW3A4707	VW3A47907	VW3A5306	–	VW3A5406	–	VW3A5504
45	60	ATV930D45M3	NSYPTDS5	–	–	–	–	–		VW3A4708	VW3A47908	VW3A5306	–	VW3A5406	–	VW3A5504
Three-phase supply voltage: 200...240 V 50/60 Hz - IP 21/UL Type 1 without braking unit																
45	60	ATV930D30M3C	NSYPTDS5	–	–	–	–	–		VW3A4707	VW3A47907	VW3A5306	–	VW3A5406	–	VW3A5504
45	60	ATV930D37M3C	NSYPTDS5	–	–	–	–	–		VW3A4707	VW3A47907	VW3A5306	–	VW3A5406	–	VW3A5504
45	60	ATV930D45M3C	NSYPTDS5	–	–	–	–	–		VW3A4708	VW3A47908	VW3A5306	–	VW3A5406	–	VW3A5504
55	75	ATV930D55M3C	–	VW3A9704	VW3A9704	–	–	–		VW3A4709	–	VW3A5307	–	–	–	VW3A5506
75	100	ATV930D75M3C	–	VW3A9704	VW3A9704	–	–	–		VW3A4710	–	VW3A5307	–	VW3A5407 (1)	–	VW3A5506
Three-phase supply voltage: 380...480 V 50/60 Hz - IP 21/UL Type 1																
0.75	–	ATV930U07N4	NSYPTDS1	–	–	VW3A46101	VW3A46120	VW3A46139	VW3A46158	VW3A4701	VW3A47901	VW3A5301	VW3A53902	VW3A5401	VW3A53901	VW3A5502
1.5	2	ATV930U15N4	NSYPTDS1	–	–	VW3A46101	VW3A46120	VW3A46139	VW3A46158	VW3A4701	VW3A47901	VW3A5301	VW3A53902	VW3A5401	VW3A53901	VW3A5502
2.2	3	ATV930U22N4	NSYPTDS1	–	–	VW3A46101	VW3A46120	VW3A46139	VW3A46158	VW3A4701	VW3A47901	VW3A5301	VW3A53902	VW3A5401	VW3A53901	VW3A5502
3	–	ATV930U30N4	NSYPTDS1	–	–	VW3A46101	VW3A46120	VW3A46139	VW3A46158	VW3A4702	VW3A47902	VW3A5302	VW3A53902	VW3A5402	VW3A53901	VW3A5502
4	5	ATV930U40N4	NSYPTDS1	–	–	VW3A46102	VW3A46121	VW3A46140	VW3A46159	VW3A4702	VW3A47902	VW3A5302	VW3A53902	VW3A5402	VW3A53901	VW3A5502
5.5	7.5	ATV930U55N4	NSYPTDS1	–	–	VW3A46102	VW3A46121	VW3A46140	VW3A46159	VW3A4702	VW3A47902	VW3A5302	VW3A53902	VW3A5402	VW3A53901	VW3A5502
7.5	10	ATV930U75N4	NSYPTDS2	–	–	VW3A46103	VW3A46122	VW3A46141	VW3A46160	VW3A4703	VW3A47903	VW3A5303	VW3A53902	VW3A5403	VW3A53902	VW3A5502
11	15	ATV930D11N4	NSYPTDS2	–	–	VW3A46104	VW3A46123	VW3A46142	VW3A46161	VW3A4703	VW3A47903	VW3A5303	VW3A53902	VW3A5403	VW3A53902	VW3A5502
15	20	ATV930D15N4	NSYPTDS3	–	–	VW3A46105	VW3A46124	VW3A46143	VW3A46162	VW3A4703	VW3A47903	VW3A5304	VW3A53903	VW3A5404	VW3A53903	VW3A5504
18.5	25	ATV930D18N4	NSYPTDS3	–	–	VW3A46106	VW3A46125	VW3A46144	VW3A46163	VW3A4704	VW3A47904	VW3A5304	VW3A53903	VW3A5404	VW3A53903	VW3A5504
22	30	ATV930D22N4	NSYPTDS3	–	–	VW3A46107	VW3A46126	VW3A46145	VW3A46164	VW3A4704	VW3A47904	VW3A5304	VW3A53903	VW3A5404	VW3A53903	VW3A5504
30	40	ATV930D30N4	NSYPTDS4	–	–	VW3A46108	VW3A46127	VW3A46146	VW3A46165	VW3A4705	VW3A47905	VW3A5305	VW3A53905	VW3A5405	VW3A53904	VW3A5504
37	50	ATV930D37N4	NSYPTDS4	–	–	VW3A46109	VW3A46128	VW3A46147	VW3A46166	VW3A4706	VW3A47906	VW3A5305	VW3A53905	VW3A5405	VW3A53904	VW3A5504
45	60	ATV930D45N4	NSYPTDS4	–	–	VW3A46110	VW3A46129	VW3A46148	VW3A46167	VW3A4706	VW3A47906	VW3A5305	VW3A53905	VW3A5405	VW3A53904	VW3A5504
55	75	ATV930D55N4	NSYPTDS5	–	–	VW3A46111	VW3A46130	VW3A46149	VW3A46168	VW3A4707	VW3A47907	VW3A5306	–	VW3A5406	–	VW3A5504
75	100	ATV930D75N4	NSYPTDS5	–	–	VW3A46112	VW3A46131	VW3A46150	VW3A46169	VW3A4708	VW3A47908	VW3A5306	–	VW3A5406	–	VW3A5504
90	125	ATV930D90N4	NSYPTDS5	–	–	VW3A46113	VW3A46132	VW3A46151	VW3A46170	VW3A4708	VW3A47908	VW3A5306	–	VW3A5406	–	VW3A5504
200	350	ATV930C22N4	–	VW3A9212	VW3A9112	VW3A46118	VW3A46137	VW3A46155	VW3A46174	VW3A4411	–	VW3A5106	–	VW3A5209	–	–
Three-phase supply voltage: 380...480 V 50/60 Hz - IP 21/UL Type 1 without braking unit																
55	75	ATV930D55N4C	NSYPTDS5	–	–	VW3A46111	VW3A46130	VW3A46149	VW3A46168	VW3A4707	VW3A47907	VW3A5306	–	VW3A5406	–	VW3A5504
75	100	ATV930D75N4C	NSYPTDS5	–	–	VW3A46112	VW3A46131	VW3A46150	VW3A46169	VW3A4708	VW3A47908	VW3A5306	–	VW3A5406	–	VW3A5504
90	125	ATV930D90N4C	NSYPTDS5	–	–	VW3A46113	VW3A46132	VW3A46151	VW3A46170	VW3A4708	VW3A47908	VW3A5306	–	VW3A5406	–	VW3A5504
110	150	ATV930C11N4C	–	VW3A9704	VW3A9704	VW3A46114	VW3A46133	VW3A46152	VW3A46171	VW3A4709	–	VW3A5307	–	–	–	VW3A5506
132	200	ATV930C13N4C	–	VW3A9704	VW3A9704	VW3A46115	VW3A46134	VW3A46153	VW3A46172	VW3A4709	–	VW3A5307	–	VW3A5407 (1)	–	VW3A5506
160	250	ATV930C16N4C	–	VW3A9704	VW3A9704	VW3A46116	VW3A46135	VW3A46154	VW3A46173	VW3A4710	–	VW3A5307	–	VW3A5407 (1)	–	VW3A5506
220	350	ATV930C22N4C	–	VW3A9212	VW3A9112	VW3A46118	VW3A46137	VW3A46155	VW3A46174	VW3A4411	–	VW3A5106	–	VW3A5209	–	–
250	400	ATV930C25N4C	–	VW3A9213 (3) VW3A9214 (4)	VW3A9113 (3) VW3A9114 (4)	VW3A46119	VW3A46138	VW3A46157	VW3A46176	VW3A4411	–	VW3A5107	–	VW3A5210	–	–
315	500	ATV930C31N4C	–	VW3A9213 (3) VW3A9214 (4)	VW3A9113 (3) VW3A9114 (4)	2 x VW3A46116	2 x VW3A46135	2 x VW3A46153	2 x VW3A46172	VW3A4411	–	VW3A5107	–	VW3A5210	–	–
Pages	18		24	25	25	46	48	50	51	52	53	54	55	56	57	58

(1) In "Normal Duty", apply a derating of Pn-1 to the drive nominal power with a minimum switching frequency of 4 kHz. For example: an ATV630D75M3 drive with sinus filter can be used on a 55 kW motor.
 (2) Maximum length of unshielded cable: 300 m. For other lengths or for shielded cables, see page 58.
 (3) Without braking resistor.
 (4) With braking resistor.

Table showing possible combinations of options for ATV950...N4/N4E drives

Motor	Drive	Accessories		Options				EMC filters	IP 21 kit for EMC filter	dv/dt filters	IP 21 kit for dv/dt filter	Sinus filter	IP 21 kit for sinus filter	Common mode filters (3)	
		Flange-mounting kit	Kit for IP 21 / UL Type 1 conformity	Passive filters (50 Hz)		Passive filters (60 Hz)									
kW	HP			THDI < 10%	THDI < 5%	THDI < 10%	THDI < 5%								
Three-phase supply voltage: 380...480 V 50/60 Hz - IP 55															
0.75	1	ATV950U07N4	–	–	VW3A46101 (1)	VW3A46120 (1)	VW3A46139 (1)	VW3A46158 (1)	VW3A4701	–	VW3A5301	–	VW3A5401 (1)	–	VW3A5502
1.5	2	ATV950U15N4	–	–	VW3A46101 (1)	VW3A46120 (1)	VW3A46139 (1)	VW3A46158 (1)	VW3A4701	–	VW3A5301	–	VW3A5401 (1)	–	VW3A5502
2.2	3	ATV950U22N4	–	–	VW3A46101 (1)	VW3A46120 (1)	VW3A46139 (1)	VW3A46158 (1)	VW3A4701	–	VW3A5301	–	VW3A5401 (1)	–	VW3A5502
3	–	ATV950U30N4	–	–	VW3A46101 (1)	VW3A46120 (1)	VW3A46139 (1)	VW3A46158 (1)	VW3A4702	–	VW3A5302	–	VW3A5402 (1)	–	VW3A5502
4	5	ATV950U40N4	–	–	VW3A46102 (1)	VW3A46121 (1)	VW3A46140 (1)	VW3A46159 (1)	VW3A4702	–	VW3A5302	–	VW3A5402 (1)	–	VW3A5502
5.5	7.5	ATV950U55N4	–	–	VW3A46102 (1)	VW3A46121 (1)	VW3A46140 (1)	VW3A46159 (1)	VW3A4702	–	VW3A5302	–	VW3A5402 (1)	–	VW3A5502
7.5	10	ATV950U75N4	–	–	VW3A46103 (1)	VW3A46122 (1)	VW3A46141 (1)	VW3A46160 (1)	VW3A4703	–	VW3A5303	–	VW3A5403 (1)	–	VW3A5502
11	15	ATV950D11N4	–	–	VW3A46104 (1)	VW3A46123 (1)	VW3A46142 (1)	VW3A46161 (1)	VW3A4703	–	VW3A5303	–	VW3A5403 (1)	–	VW3A5502
15	20	ATV950D15N4	–	–	VW3A46105 (1)	VW3A46124 (1)	VW3A46143 (1)	VW3A46162 (1)	VW3A4703	–	VW3A5304	–	VW3A5404 (1)	–	VW3A5504
18.5	25	ATV950D18N4	–	–	VW3A46106 (1)	VW3A46125 (1)	VW3A46144 (1)	VW3A46163 (1)	VW3A4704	–	VW3A5304	–	VW3A5404 (1)	–	VW3A5504
22	30	ATV950D22N4	–	–	VW3A46107 (1)	VW3A46126 (1)	VW3A46145 (1)	VW3A46164 (1)	VW3A4704	–	VW3A5304	–	VW3A5404 (1)	–	VW3A5504
30	40	ATV950D30N4	–	–	VW3A46108 (1)	VW3A46127 (1)	VW3A46146 (1)	VW3A46165 (1)	VW3A4705	–	VW3A5305	–	VW3A5405 (1)	–	VW3A5504
37	50	ATV950D37N4	–	–	VW3A46109 (1)	VW3A46128 (1)	VW3A46147 (1)	VW3A46166 (1)	VW3A4706	–	VW3A5305	–	VW3A5405 (1)	–	VW3A5504
45	60	ATV950D45N4	–	–	VW3A46110 (1)	VW3A46129 (1)	VW3A46148 (1)	VW3A46167 (1)	VW3A4706	–	VW3A5305	–	VW3A5405 (1)	–	VW3A5504
55	75	ATV950D55N4	–	–	VW3A46111 (1)	VW3A46130 (1)	VW3A46149 (1)	VW3A46168 (1)	VW3A4707	–	VW3A5306	–	VW3A5406 (1)	–	VW3A5504
75	100	ATV950D75N4	–	–	VW3A46112 (1)	VW3A46131 (1)	VW3A46150 (1)	VW3A46169 (1)	VW3A4708	–	VW3A5306	–	VW3A5406 (1)	–	VW3A5504
90	125	ATV950D90N4	–	–	VW3A46113 (1)	VW3A46132 (1)	VW3A46151 (1)	VW3A46170 (1)	VW3A4708	–	VW3A5306	–	VW3A5406 (1)	–	VW3A5504

Three-phase supply voltage: 380...480 V 50/60 Hz - IP 55 with Vario disconnect switch

0.75	1	ATV950U07N4E	–	–	VW3A46101 (1)	VW3A46120 (1)	VW3A46139 (1)	VW3A46158 (1)	VW3A4701	–	VW3A5301	–	VW3A5401 (1)	–	VW3A5502
1.5	2	ATV950U15N4E	–	–	VW3A46101 (1)	VW3A46120 (1)	VW3A46139 (1)	VW3A46158 (1)	VW3A4701	–	VW3A5301	–	VW3A5401 (1)	–	VW3A5502
2.2	3	ATV950U22N4E	–	–	VW3A46101 (1)	VW3A46120 (1)	VW3A46139 (1)	VW3A46158 (1)	VW3A4701	–	VW3A5301	–	VW3A5401 (1)	–	VW3A5502
3	–	ATV950U30N4E	–	–	VW3A46101 (1)	VW3A46120 (1)	VW3A46139 (1)	VW3A46158 (1)	VW3A4702	–	VW3A5302	–	VW3A5402 (1)	–	VW3A5502
4	5	ATV950U40N4E	–	–	VW3A46102 (1)	VW3A46121 (1)	VW3A46140 (1)	VW3A46159 (1)	VW3A4702	–	VW3A5302	–	VW3A5402 (1)	–	VW3A5502
5.5	7.5	ATV950U55N4E	–	–	VW3A46102 (1)	VW3A46121 (1)	VW3A46140 (1)	VW3A46159 (1)	VW3A4702	–	VW3A5302	–	VW3A5402 (1)	–	VW3A5502
7.5	10	ATV950U75N4E	–	–	VW3A46103 (1)	VW3A46122 (1)	VW3A46141 (1)	VW3A46160 (1)	VW3A4703	–	VW3A5303	–	VW3A5403 (1)	–	VW3A5502
11	15	ATV950D11N4E	–	–	VW3A46104 (1)	VW3A46123 (1)	VW3A46142 (1)	VW3A46161 (1)	VW3A4703	–	VW3A5303	–	VW3A5403 (1)	–	VW3A5502
15	20	ATV950D15N4E	–	–	VW3A46105 (1)	VW3A46124 (1)	VW3A46143 (1)	VW3A46162 (1)	VW3A4703	–	VW3A5304	–	VW3A5404 (1)	–	VW3A5504
18.5	25	ATV950D18N4E	–	–	VW3A46106 (1)	VW3A46125 (1)	VW3A46144 (1)	VW3A46163 (1)	VW3A4704	–	VW3A5304	–	VW3A5404 (1)	–	VW3A5504
22	30	ATV950D22N4E	–	–	VW3A46107 (1)	VW3A46126 (1)	VW3A46145 (1)	VW3A46164 (1)	VW3A4704	–	VW3A5304	–	VW3A5404 (1)	–	VW3A5504
30	40	ATV950D30N4E	–	–	VW3A46108 (1)	VW3A46127 (1)	VW3A46146 (1)	VW3A46165 (1)	VW3A4705	–	VW3A5305	–	VW3A5405 (1)	–	VW3A5504
37	50	ATV950D37N4E	–	–	VW3A46109 (1)	VW3A46128 (1)	VW3A46147 (1)	VW3A46166 (1)	VW3A4706	–	VW3A5305	–	VW3A5405 (1)	–	VW3A5504
45	60	ATV950D45N4E	–	–	VW3A46110 (1)	VW3A46129 (1)	VW3A46148 (1)	VW3A46167 (1)	VW3A4706	–	VW3A5305	–	VW3A5405 (1)	–	VW3A5504
55	75	ATV950D55N4E	–	–	VW3A46111 (1)	VW3A46130 (1)	VW3A46149 (1)	VW3A46168 (1)	VW3A4707	–	VW3A5306	–	VW3A5406 (1)	–	VW3A5504
75	100	ATV950D75N4E	–	–	VW3A46112 (1)	VW3A46131 (1)	VW3A46150 (1)	VW3A46169 (1)	VW3A4708	–	VW3A5306	–	VW3A5406 (1)	–	VW3A5504
90	125	ATV950D90N4E	–	–	VW3A46113 (1)	VW3A46132 (1)	VW3A46151 (1)	VW3A46170 (1)	VW3A4708	–	VW3A5306	–	VW3A5406 (1)	–	VW3A5504

Pages	21	–	–	46	48	50	51	52	–	54	–	56	–	58
--------------	----	---	---	----	----	----	----	----	---	----	---	----	---	----

I/O extension modules

Description	Reference	Page
Module with digital and analog I/O	VW3A3203	35
Module with relay outputs	VW3A3204	35

Encoder interface modules

Description	Reference	Page
Digital interface encoder module	VW3A3420	34
Analog interface encoder module	VW3A3422	34
Resolver interface module	VW3A3423	18

List of fieldbus modules (2)

Description	Reference	Page
CANopen Daisy chain	VW3A3608	39
CANopen SUB-D	VW3A3618	39
CANopen screw terminal block	VW3A3628	40
PROFINET	VW3A3627	41
PROFIBUS DP V1	VW3A3607	41
DeviceNet	VW3A3609	41

(1) When used with ATV950U07N4/N4E...D90N4/N4E drives, the filter must be mounted in a separate enclosure to maintain IP 55 protection for the installation.
 (2) For module compatibility table, see opposite.

Module compatibility table

Module type	Digital and analog I/O VW3A3203 (4)	Relay outputs VW3A3204 (4)	Fieldbuses VW3A36... (5)	Encoder interface modules VW3A3420, VW3A3422 and VW3A3423 (5)
Digital and analog I/O VW3A3203	■	■	■	■
Relay outputs VW3A3204	■	■	■	■
Fieldbuses VW3A36...	■	■	■	■
Encoder interface modules VW3A3420, VW3A3422 and VW3A3423	■	■	■	■

■ Combination possible

■ Combination impossible

(3) Maximum length of unshielded cable: 300 m. For other lengths or for shielded cables, see page 58.

(4) Maximum combination involving two types of module is 2.

(5) Maximum combination involving two types of module is 1.



VW3A3423 resolver encoder interface module



VW3A3420 digital interface encoder module 5/12 V



VW3A3422 analog interface encoder module

Presentation

Encoder interface modules are used for Flux Vector Control operation with sensor (FVC mode) for asynchronous motors, or for Vector Control operation with speed feedback (FSY mode) for synchronous motors.

They improve drive performance irrespective of the motor load state:

- Zero speed torque
- Accurate speed regulation
- Torque accuracy
- Shorter response times on a torque surge
- Improved dynamic performance in transient state

For asynchronous motors, in the other control modes (voltage vector control, voltage/frequency ratio), encoder interface modules improve static speed accuracy.

Depending on the model, encoder interface modules can also be used for monitoring, irrespective of the control type:

- Overspeed detection
- Load slipping detection

They can also transmit a reference value provided by the encoder input to the Altivar variable speed drive. This specific feature is used to synchronize the speed of several drives. The encoder options have a thermal sensor input to monitor one standard temperature sensor.

3 modules are available depending on the encoder technology:

- Resolver encoder
- Encoder with digital output
- Encoder with analog output

The Altivar variable speed drive can only be equipped with one of the encoder interface modules. The interface encoder module is inserted in a dedicated slot. It is protected against encoder supply short circuits and overloads.

References

Description	Technology type	Used with encoder (1)	Power supply	Maximum current	Maximum cable length	Maximum operating frequency	Supported thermal sensors	Reference	Weight
			V ~	mA	m/ft	kHz			kg/lb
Resolver interface module	Resolver	–	–	50	100/328	3...12	PTC (digital/linear), PT100, PT1000, Klixon	VW3A3423	0.150/ 0.331
Digital interface encoder module 5/12 V	A/B/I	XCC1●●●●●●R XCC1●●●●●●X	5, 12 or 24	250, 100	100/328	1,000	PTC (digital/linear), PT100, PT1000, Klixon	VW3A3420	0.150/ 0.331
	SSI	XCC2●●●●●●S●● XCC3●●●●●●S●●	5, 12 or 24	250, 100	50/164 (2)	1,000 (2)			
	EnDat® 2.2		5, 12 or 24	250, 100	50/164 (2)	1,000 (2)			
Analog interface encoder module	1 Vpp		5, 12 or 24	250, 100	100/328	100	PTC (digital/linear), PT100, PT1000, Klixon	VW3A3422	0.150/ 0.331
	SinCos Hiperface®		5, 12 or 24	250, 100	100/328	100			

Connection accessories (3)

Description	Composition	Length m/ft	Reference	Weight kg/lb
Cordset				
Cordset equipped with 1 x 15-way high density male SUB-D connector for digital or analog encoder modules	–	1/3.28	VW3M4701	–
Connecting cable				
Cable for creating cordsets for encoder interface modules	5 x (2 x 0.25 mm ² /AWG 24) + 1 x (2 x 0.5 mm ² /AWG 20)	100/328	VW3M8221R1000	21.000/ 46.297

(1) To determine the complete reference, please refer to the "Detection for the automation solution - OsiSense" catalog or our website www.schneider-electric.com.

(2) With propagation delay compensation on EnDat® up to 100 m/328 ft and higher maximum frequencies possible, SSI 300 kHz up to 100m/328ft possible.

(3) See the complete list of connection accessories on our website www.schneider-electric.com.

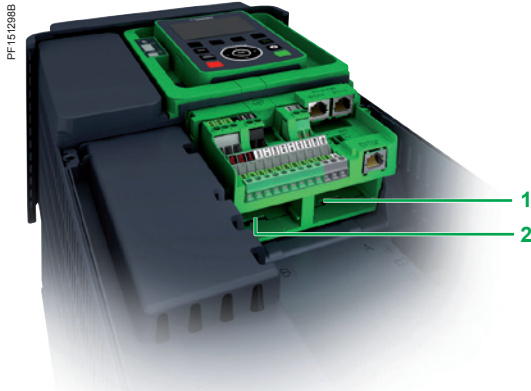

I/O extension modules

Presentation

By installing I/O extension modules Altivar Process drives can be adapted to meet the needs of applications that manage additional sensors or specific sensors.

2 extension modules are available:

- Module with digital and analog I/O
- Module with relay outputs

These modules are inserted in slots A and B on Altivar Process drives:

- 1 Slot A for I/O extension or fieldbus modules
- 2 Slot B for I/O extension modules and encoder modules

Module with digital and analog I/O

- 2 differential analog inputs configurable via software as current (0-20 mA/4-20 mA), or for PTC, PT100, or PT1000, 2 or 3-wire
- 14-bit resolution
- 6 x 24 V $\overline{\text{V}}$ positive or negative digital inputs
- Sampling: 1 ms max
- 2 assignable digital outputs
- 2 removable spring terminal blocks

Module with relay outputs

- 3 relay outputs with NO contacts
- 1 fixed screw terminal block



VW3A3203



VW3A3204

I/O extension modules

Description	I/O type				Reference	Weight kg/lb
	Digital inputs	Digital outputs	Analog inputs	Relay outputs		
Module with digital and analog I/O	6	2	2 (1)	–	VW3A3203	–
Module with relay outputs	–	–	–	3 (2)	VW3A3204	–

(1) Differential analog inputs configurable via software as current (0-20 mA/4-20 mA), or for PTC, PT100, or PT1000, 2 or 3-wire. When configured as PTC probe inputs, they must never be used to protect an ATEX motor in applications in explosive atmospheres. Please refer to the ATEX guide on our website www.schneider-electric.com.

(2) NO contacts.

Note: Digital and analog I/O modules and relay output modules can go in either slot A or slot B on Altivar Process drives.

However, the drives cannot take 2 modules of the same type (e.g., 2 digital and analog I/O modules or 2 relay output modules).

Presentation

Altivar Process drives have 3 built-in RJ45 communication ports as standard:

- 1 EtherNet/IP and Modbus TCP dual port
- 1 serial port

Integrated communication protocols

Altivar Process drives integrate the EtherNet/IP and Modbus TCP and Modbus serial link communication protocols as standard.

■ EtherNet/IP and Modbus TCP dual port

This offers standard services regularly used in industrial networks: Connection to the Modbus TCP or EtherNet/IP network

- EtherNet IP adapter including standard CIP objects (AC/DC drive objects, CIP energy objects, etc.), compliant to ODVA specification
- The RSTP connection allows ring topology to help ensure continuity of service.
- Dual port allows daisy chain connection to simplify cabling and network infrastructure (no need to use a switch).
- Modbus TCP message handling is based on the Modbus protocol and is used to exchange process data with other network devices (e.g., a PLC). It provides Altivar Process drives with access to the Modbus protocol and to the high performance of the Ethernet network, which is the communication standard for numerous devices.
- SNMP (Simple Network Management Protocol) offers standard diagnostics services for network management tools.
- The FDR (Fast Device Replacement) service allows automatic reconfiguration of a new device installed to replace an existing device.
- Device security is reinforced by disabling some unused services as well as managing a list of authorized devices.
- Setup and adjustment tools (SoMove, Unity with DTM) can be connected locally or remotely.
- The embedded Web server is used to display operating data and dashboards as well as to configure and diagnose system elements from any web browser.

These numerous services offered by Altivar Process drives simplify integration into Schneider Electric process automation control systems like M580 ePAC or Foxboro Evo DCS.

■ Serial port

- Field network operation for exchanging data with other devices via the Modbus protocol
- Multidrop connection of the following HMIs and configuration tools:
 - The graphic display terminal supplied with the drive
 - A Magelis industrial HMI terminal
 - A PC with SoMove or Unity setup software

The detailed specifications for the EtherNet/IP or serial communication ports, and the Modbus and Modbus TCP protocols are available on our website www.schneider-electric.com.

Description

- 1 2 x RJ45 EtherNet/IP and Modbus TCP port
- 2 RJ45 serial port
- 3 Slot A for I/O extension or fieldbus modules
- 4 Slot B for I/O extension modules and encoder modules
- 5 Removable screw terminal blocks for 24 V $\bar{\text{---}}$ power supply and integrated I/O
- 6 RJ45 serial link for HMI (graphic display terminal, Magelis terminal, etc.)

Altivar Process drives can only take one fieldbus module, in slot A **3** only. They cannot take 2 modules of the same type (e.g., 2 digital and analog I/O modules or 2 relay output modules). The drives can take one digital and analog I/O module and one relay output module in either slot A **3** or slot B **4**.

Note: The user manuals and description files (*gsd*, *eds*) for devices on the fieldbuses and networks are available on our website www.schneider-electric.com.

PF151298B

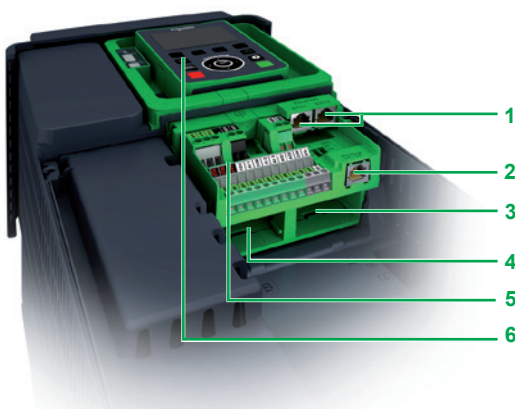

Optional fieldbus modules

The Altivar Process drive can also be connected to other industrial fieldbuses and networks by using one of the fieldbus modules available as an option. Fieldbus modules are supplied in "cassette" format for ease of mounting/removal.

Dedicated fieldbus modules:

- CANopen:
- RJ45 Daisy Chain
- Sub-D
- Screw terminal block
- EtherCAT
- PROFINET
- PROFIBUS DP V1
- DeviceNet

PROFINET and PROFIBUS DP V1 modules also support the Profidrive and CiA402 profiles.

It is possible to maintain communication using a separate power supply for the control and power sections. Monitoring and diagnostics via the network are possible even if there is no power supplied to the power section.

Functions

The drive functions can be accessed via the various communication networks:

- Configuration
- Adjustment
- Control
- Monitoring

Altivar Process drives offer a high degree of interfacing flexibility with the possibility to assign, by configuration, the different control sources (I/O, communication networks, and HMI terminal) to control functions in order to meet the requirements of complex applications.

Network services and parameters are configured using the SoMove drive setup software, or using Unity software if the drive is being integrated into a PlantStruXure architecture.

Communication is monitored according to the specific criteria for each protocol. However, regardless of the protocol, it is possible to configure how the drive responds to a detected communication interruption, as follows:

- Define the type of stop when a communication interruption is detected
- Maintain last command received
- Fallback position at preset speed
- Ignore the detected communication interruption

Variable speed drives

Altivar Process ATV900

Communication buses and networks

Integrated ports

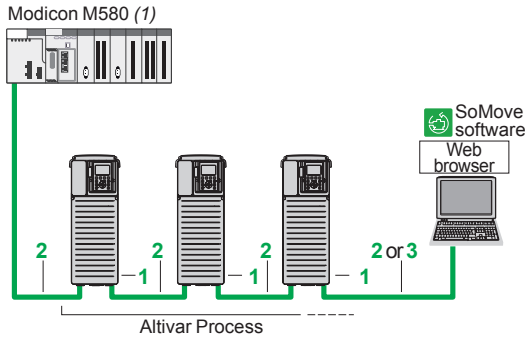

Example of connection on an EtherNet/IP network

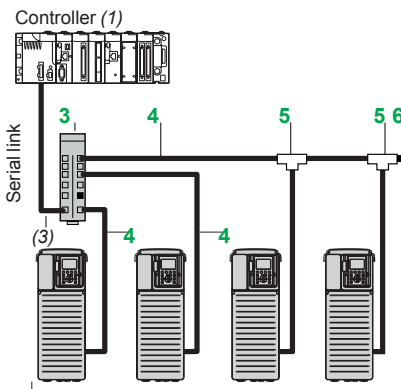

Example of serial link architecture

Integrated EtherNet/IP and Modbus TCP dual port

Description	Item	Length m/ ft	Unit reference	Weight kg/ lb
ConneXium cordsets (2)				
Straight shielded twisted pair cables equipped with 2 RJ45 connectors conforming to EIA/TIA-568 category 5 and IEC 11801/EN 50173-1, class D	2	2/ 6.56	490NTW00002	–
	5	16.40	490NTW00005	–
	12/ 39.37	490NTW00012	–	
Crossover shielded twisted pair cables equipped with 2 RJ45 connectors conforming to EIA/TIA-568 category 5 and IEC 11801/EN 50173-1, class D	3	5/ 16.40	490NTC00005	–
	15/ 49.21	490NTC00015	–	
Straight shielded twisted pair cables equipped with 2 RJ45 connectors conforming to UL and CSA 22.1	2	2/ 6.56	490NTW00002U	–
	5	16.40	490NTW00005U	–
	12/ 39.37	490NTW00012U	–	
Crossover shielded twisted pair cables equipped with 2 RJ45 connectors conforming to UL and CSA 22.1	3	5/ 16.40	490NTC00005U	–
	15/ 49.21	490NTC00015U	–	

Integrated serial port

Description	Item	Length m/ ft	Unit reference	Weight kg/ lb	
Connection accessories					
Splitter box 10 RJ45 connectors and 1 screw terminal block	3	–	LU9GC3	0.500/ 1.102	
Modbus T-junction boxes	With 0.3m/0.98 ft integrated cable	5	0.3/ 0.98	VW3A8306TF03	0.190/ 0.419
	With 1 m/3.28 ft integrated cable	5	1/ 3.28	VW3A8306TF10	0.210/ 0.463
Modbus line terminator (4) For RJ45 connector	R = 120 Ω C = 1 nf	6	–	VW3A8306RC	0.010/ 0.022
Cordsets equipped with 2 RJ45 connectors	4	0.3/ 0.98	VW3A8306R03	0.025/ 0.055	
	1/ 3.28	VW3A8306R10	0.060/ 0.132		
	3/ 9.84	VW3A8306R30	0.130/ 0.287		

(1) Please refer to the "Modicon automation platform" catalogs on our website www.schneider-electric.com.

(2) Also exist in 40 and 80 m/131 and 262 ft lengths. For other ConneXium connection accessories, please consult our website www.schneider-electric.com.

(3) Cable depends on the PLC.

(4) Sold in lots of 2.

Variable speed drives

Altivar Process ATV900

Communication buses and networks

Option: Communication modules



VW3A3608



VW3A3618

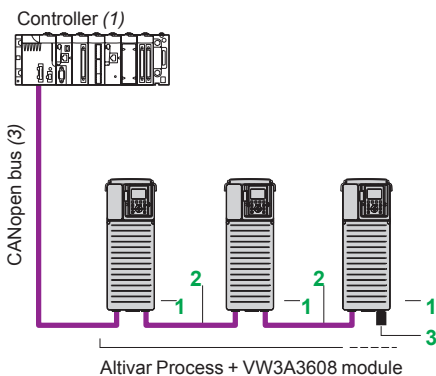

Optimized solution for daisy chain connection to the CANopen bus

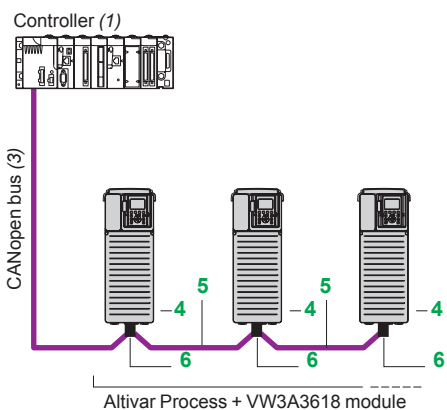

Example of connection to the CANopen bus via SUB-D connector

CANopen bus (1)

Description	Item	Length m/ ft	Unit reference	Weight kg/ lb
-------------	------	--------------------	-------------------	---------------------

Fieldbus module

CANopen Daisy chain module Ports: 2 RJ45 connectors	1	–	VW3A3608	–
---	----------	---	-----------------	---

Connection to RJ45 connector (optimized solution for daisy chain connection on CANopen bus)

CANopen cordsets equipped with 2 RJ45 connectors	2	0.3/ 0.98	VW3CANCARR03	0.050/ 0.110
		1/ 3.28	VW3CANCARR1	0.500/ 1.102

CANopen line terminator for RJ45 connector	3	–	TCSCAR013M120	–
---	----------	---	----------------------	---

Fieldbus module

CANopen SUB-D module Ports: 1 x 9-way male SUB-D connector	4	–	VW3A3618	–
--	----------	---	-----------------	---

Connection to SUB-D connector

CANopen cables (3) (4) Standard cable, CE mark Low smoke zero halogen. Flame-retardant (IEC 60332-1)	5	50/ 164.04	TSXCANCA50	4.930/ 10.869
		100/ 328.08	TSXCANCA100	8.800/ 19.401
		300/ 984.25	TSXCANCA300	24.560/ 54.145

CANopen cables (3) (4) UL certification, CE mark Flame-retardant (IEC 60332-2)	5	50/ 164.04	TSXCANCB50	3.580/ 7.893
		100/ 328.08	TSXCANCB100	7.840/ 17.284
		300/ 984.25	TSXCANCB300	21.870/ 48.215

CANopen cables (3) (4) Cable for harsh environments or mobile installations, CE mark Low smoke zero halogen Flame-retardant (IEC 60332-1)	5	50/ 164.04	TSXCANCD50	3.510/ 7.738
		100/ 328.08	TSXCANCD100	7.770/ 17.130
		300/ 984.25	TSXCANCD300	7.770/ 17.130

IP 20 straight CANopen connector (5) 9-way female SUB-D connector with line terminator that can be deactivated For connecting CAN-H, CAN-L, CAN-GND	6	–	TSXCANKCDF180T	0.049/ 0.108
--	----------	---	-----------------------	-----------------

- (1) Altivar Process drives can only take one fieldbus module.
 (2) Please refer to the "Modicon automation platform" catalogs on our website www.schneider-electric.com.
 (3) Cable depends on the PLC.
 (4) Standard environment:
 - No particular environmental constraints
 - Operating temperature between +5 °C and +60 °C/+41 °F and +140 °F
 - Fixed installation
 Harsh environment:
 - Resistance to hydrocarbons, industrial oils, detergents, solder splashes
 - Relative humidity up to 100%
 - Saline atmosphere
 - Operating temperature between -10 °C and +70 °C/+14 °F and 158 °F
 - Significant temperature variations
 (5) Only straight connectors are compatible with Altivar Process drives.

Variable speed drives

Altivar Process ATV900

Communication buses and networks

Option: Communication modules



VW3A3628

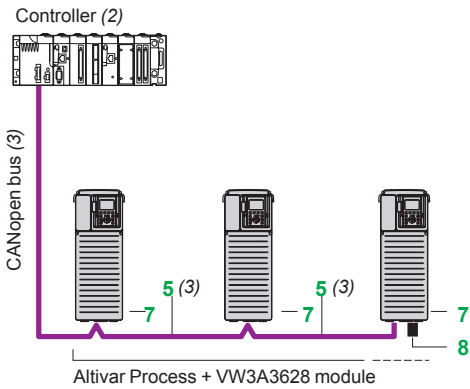

Example of connection to the CANopen bus with a screw terminal block

CANopen bus (continued) (1)

Description	Item	Length m/ ft	Unit reference	Weight kg/ lb
-------------	------	--------------------	-------------------	---------------------

Fieldbus module

CANopen module Port: 1 x 5-way screw terminal block	7	–	VW3A3628	–
---	---	---	----------	---

Connection to screw terminal block

CANopen IP 20 cordsets (3) equipped with 2 x 9-way female SUB-D connectors Standard cable, C€ mark. Low smoke zero halogen Flame-retardant (IEC 60332-1)	5	0.3/ 0.98	TSXCANCADD03	0.091/ 0.201
		1/ 3.28	TSXCANCADD1	0.143/ 0.315
		3/ 9.84	TSXCANCBDD3	0.268/ 0.591
		5/ 16.40	TSXCANCBDD5	0.400/ 0.882

IP 20 CANopen tap junction boxes equipped with: ■ 4 x 9-way male SUB-D connectors + screw terminal block for trunk cable tap link ■ Line terminator	–	–	TSXCANTDM4	0.196/ 0.432
--	---	---	------------	-----------------

IP 20 CANopen tap junction boxes equipped with: ■ 2 screw terminal blocks for trunk cable tap link ■ 2 RJ45 connectors for connecting drives ■ 1 RJ45 connector for connecting a PC	–	–	VW3CANTAP2	–
--	---	---	------------	---

CANopen line terminator for screw terminal connector (4)	8	–	TCSCAR01NM120	–
---	---	---	---------------	---

(1) Altivar Process drives can only take one fieldbus module.
 (2) Please refer to the "Modicon automation platform" catalogs on our website www.schneider-electric.com.
 (3) Cable depends on the PLC.
 (4) Sold in lots of 2.

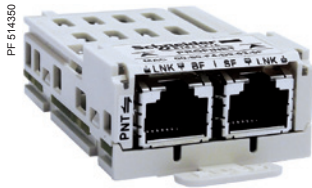

VW3A3627



VW3A3607



VW3A3601



VW3A3609

PROFINET bus (1)

Description	Reference	Weight kg/ lb
Fieldbus module		
PROFINET module equipped with 2 RJ45 connectors	VW3A3627	0.290/ 0.639

PROFIBUS DP V1 bus (1)

Description	Reference	Weight kg/ lb
Fieldbus module		
PROFIBUS DP V1 module Port: 1 x 9-way female SUB-D connector Conforming to PROFIBUS DP V1 Profiles supported: ■ CiA 402 drive ■ Profidrive Offers several message handling modes based on DP V1	VW3A3607	0.140/ 0.309

SUB-D connection

IP 20 straight connectors (2) for Profibus module	LU9AD7	–
--	---------------	---

EtherCAT bus (1)

Description	Reference	Weight kg/ lb
Fieldbus module		
EtherCAT module equipped with 2 RJ45 connectors	VW3A3601	0.290/ 0.639

DeviceNet bus (1)

Description	Reference	Weight kg/ lb
Fieldbus module		
DeviceNet module Port: 1 removable 5-way screw connector Profiles supported: ■ CIP AC DRIVE ■ CiA 402 drive	VW3A3609	0.300/ 0.661

(1) Altivar Process drives can only take one fieldbus module.

(2) Only straight connectors are compatible with Altivar Process drives.

Presentation

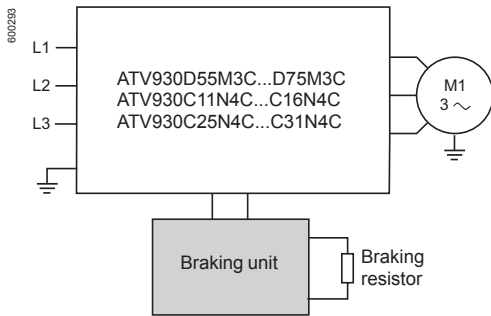

Braking units allow Altivar Process drives to operate while braking to a standstill or during "generator" operation, by dissipating the energy in the braking resistor.

ATV930U07M3...D45M3, ATV930U07N4...C22N4 and ATV950U07N4...D90N4 drives have a built-in dynamic brake transistor.

For ATV930D55M3C...D75M3C, ATV930C11N4C...C16N4C and ATV930C25N4C...C31N4C drives, a braking unit must be used.

Braking units provide IP 20 protection. Thermal protection is given by an integrated temperature probe.

Applications

High-inertia machines, machines with slow and fast cycles, high-power machines performing vertical movements.

References

For drives	Power		Losses	Cable (drive-braking unit)		Cable (braking unit-resistors)		Percentage of conduction time	Minimum resistor value	Reference	Weight
	Continuous	Maximum	At continuous power	Cross-section	Maximum length	Cross-section	Maximum length				
	kW	kW	W	mm ²	m	mm ²	m	%	Ohms		kg/lb
Supply voltage: 200...240 V 50/60 Hz											
ATV930D55M3C ...D75M3C	60	80	400	3 x 120	10	3 x 120	10	5% at 150 kW 15% at 120 kW 50% at 95 kW	1	VW3A7106	28.000/ 61.729
Supply voltage: 380...480 V 50/60 Hz											
ATV930C11N4C ...C16N4C	100	160	400	2 x 120	5	2 x 120	5	5% at 320 kW 15% at 250 kW 50% at 200 kW	2	VW3A7105	28.000/ 61.729
ATV930C25N4C	200	420	550	– (1)	– (1)	2 x 95	50	5% at 420 kW 15% at 320 kW 50% at 250 kW	1	VW3A7101	30.000/ 66.139
ATV930C31N4C	400	1050	1050	2 x 150	1	2 x 150	50	5% at 750 kW 15% at 550 kW 50% at 440 kW	0.7	VW3A7102	80.000/ 176.370

(1) For the ATV930C25N4C variable speed drive, the braking unit is connected to the drive with internal connections.

Presentation

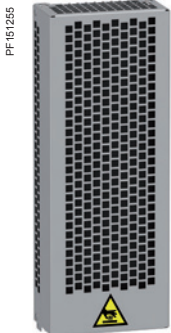

VW3A7741

Braking resistors allow Altivar Process drives to operate while braking to a standstill, by dissipating the braking energy. They enable maximum transient braking torque.

Braking resistors are designed to be located outside the enclosure, but should not inhibit natural cooling. Air inlets and outlets must not be obstructed in any way. The air must be free of dust, corrosive gas, and condensation.

Several resistor models are available, depending on the drive rating:

- With IP 20 and IP 23 casing and thermal protection provided by temperature-controlled switch or by the drive

The internal circuits of Altivar Process drives rated 90 kW or less have a built-in dynamic brake transistor.

An external braking unit is necessary for wall-mounting Altivar Process drives between 110 kW and 315 kW at 400...480 V as well as 55 kW and 75 kW at 200...240 V.

Applications

Braking resistors are designed for a defined cycle (see the 3 cycle types defined below).

Depending on your own applications and cycles, you can use these resistors or define a new value.

- Braking resistors for light braking cycles for machines with cycles and inertia. The braking power is limited to 1.5 Tn for 0.8 s every 40 s.
- Braking resistors for medium braking cycles for machines with high inertia and conveyors. The braking power is limited to 1.35 Tn for 4 s every 40 s.
- Braking resistors for severe braking cycles for machines with very high inertia and vertical movements (hoisting). The braking power is limited to 1.65 Tn for 6 s and Tn for 54 s every 120 s.

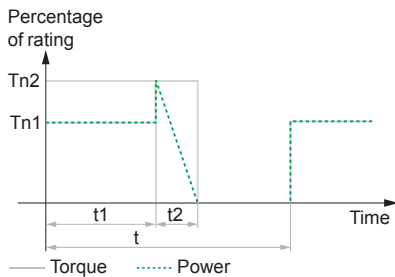

Light Cycle

$t = 40 \text{ s}$	t : period
$t1 = 0 \text{ s}$	$Tn1$: braking torque
$t2 = 0.8 \text{ s}$	$Tn2$: braking torque
$Tn1 = 0$	Tn : nominal torque
$Tn2 = 1.5 \times Tn$	

References for a light braking cycle

For drives	Degree of protection of the resistor	Ohmic value at 20 °C/ 68 °F	Average power available at 50 °C/ 122 °F (1)	Quantity required per drive	Reference	Weight
		Ω	kW			
Supply voltage: 200...240 V or 380...480 V 50/60 Hz						
ATV930U07M3	IP20	100	0.1	1	VW3A7730	1.500/ 3.307
ATV930U07N4...U40N4						
ATV950U07N4...U40N4						
ATV950U07N4E...U40N4E						
ATV930U15M3...U22M3	IP20	60	0.16	1	VW3A7731	2.000/ 4.409
ATV930U55N4...U75N4						
ATV950U55N4...U75N4						
ATV950U55N4E...U75N4E						
ATV930U30M3...U40M3	IP20	28	0.3	1	VW3A7732	3.000/ 6.614
ATV930D11N4...D15N4						
ATV950D11N4...D15N4						
ATV950D11N4E...D15N4E						
ATV930U55M3...U75M3	IP20	16	1.1	1	VW3A7733	4.000/ 8.818
ATV930D18N4...D30N4						
ATV950D18N4...D30N4						
ATV950D18N4E...D30N4E						
ATV930D11M3	IP20	10	1.1	1	VW3A7734	5.500/ 12.125
ATV930D37N4...D45N4						
ATV950D37N4...D45N4						
ATV950D37N4E...D45N4E						
ATV930D15M3	IP20	8	1.1	1	VW3A7735	5.500/ 12.125
ATV930D55N4						
ATV950D55N4						
ATV950D55N4E						
ATV930D18M3...D22M3	IP23	5	1.9	1	VW3A7736	18.000/ 39.683
ATV930D75N4...D90N4						
ATV950D75N4...D90N4						
ATV950D75N4E...D90N4E						
ATV930D30M3...D45M3	IP23	2.5	3.2	1	VW3A7737	21.000/ 46.297
ATV930C11N4C...C16N4C						
ATV930C31N4C	IP23	2.5	3.2	2		
ATV930D55M3C...D75M3C	IP23	1.4	1.5	1	VW3A7738	16.000/ 35.274
ATV930C22N4	IP23	1.4	5.1	1	VW3A7748	29.000/ 69.934
ATV930C25N4C						

(1) Load factor for resistors: The value of the average power that can be dissipated at 50 °C/122 °F from the resistor into the casing is determined for a load factor during braking that corresponds to the majority of normal applications:

- Normal duty: 0.8 s braking with a 1.2 Tn braking torque for a 40 s cycle
- Heavy duty: 0.8 s braking with a 1.5 Tn braking torque for a 40 s cycle

Variable speed drives

Altivar Process ATV900

Option: Braking resistors

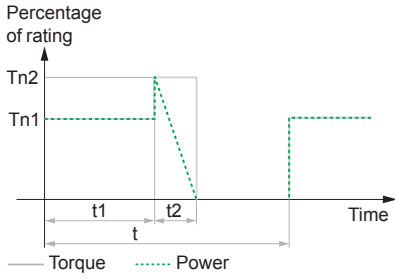

Medium Cycle	
$t = 40\text{ s}$	t : period
$t1 = 0\text{ s}$	$Tn1$: braking torque
$t2 = 4\text{ s}$	$Tn2$: braking torque
$Tn1 = 0$	Tn : nominal torque
$Tn2 = 1.35 \times Tn$	

References for a medium braking cycle						
For drives	Degree of protection of the resistor	Ohmic value at 20 °C/ 68 °F	Average power available at 50 °C/ 122 °F (1)	Quantity required per drive	Reference	Weight
		Ω	kW			kg/lb
Supply voltage: 200...240 V or 380...480 V 50/60 Hz						
ATV930U07M3 ATV930U07N4...U15N4 ATV950U07N4...U15N4 ATV950U07N4E...U15N4E	IP20	100	0.1	1	VW3A7730	1.500/ 3.307
ATV930U15M3...U22M3	IP20	60	0.16	1	VW3A7731	2.000/ 4.409
ATV930U30M3...U40M3	IP20	28	0.3	1	VW3A7732	3.000/ 6.614
ATV930U55M3...U75M3	IP20	16	1.1	1	VW3A7733	4.000/ 8.818
ATV930D11M3	IP20	10	1.1	1	VW3A7734	5.500/ 12.125
ATV930D15M3	IP20	8	1.1	1	VW3A7735	5.500/ 12.125
ATV930D18M3...D22M3	IP23	5	1.9	1	VW3A7736	18.000/ 39.684
ATV930D30M3...D45M3	IP23	2.5	3.2	1	VW3A7737	20.000/ 44.092
ATV930U22N4...U40N4 ATV950U22N4...U40N4 ATV950U22N4E...U40N4E	IP20	100	0.26	1	VW3A7740	2.500/ 5.512
ATV930U55N4...U75N4 ATV950U55N4...U75N4 ATV950U55N4E...U75N4E	IP20	60	0.5	1	VW3A7741	4.500/ 9.921
ATV930D11N4...D15N4 ATV950D11N4...D15N4 ATV950D11N4E...D15N4E	IP20	28	1.1	1	VW3A7742	4.000/ 8.818
ATV930D18N4...D30N4 ATV950D18N4...D30N4 ATV950D18N4E...D30N4E	IP20	16	2.2	1	VW3A7743	7.000/ 15.432
ATV930D37N4...D45N4 ATV950D37N4...D45N4 ATV950D37N4E...D45N4E	IP20	10	3.4	1	VW3A7744	11.500/ 25.353
ATV930D55N4 ATV950D55N4 ATV950D55N4E	IP23	8	3.8	1	VW3A7745	23.000/ 50.706
ATV930D75N4...D90N4 ATV950D75N4...D90N4 ATV950D75N4E...D90N4E	IP23	5	6.9	1	VW3A7746	27.000/ 59.525
ATV930C11N4C...C16N4C	IP23	2.5	11	1	VW3A7747	43.000/ 94.799
ATV930D55M3C...D75M3C	IP23	1.4	5.1	1	VW3A7748	25.000/ 55.116
ATV930C22N4 ATV930C25N4C...C31N4C	IP23	1.4	29	1	VW3A7757	121.000/ 69.934

(1) Load factor for resistors: The value of the average power that can be dissipated at 50 °C/122 °F from the resistor into the casing is determined for a load factor during braking that corresponds to the majority of normal applications:

- Normal duty: 4 s braking with a 1.35 Tn braking torque for a 40 s cycle
- Heavy duty: 4 s braking with a 1.65 Tn braking torque for a 40 s cycle

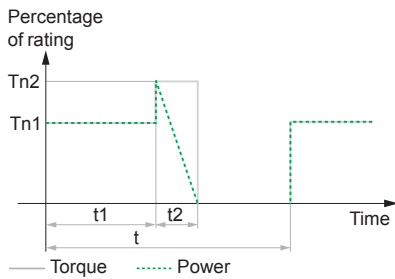

Severe Cycle	
$t = 120\text{ s}$	t : period
$t_1 = 54\text{ s}$	T_{n1} : braking torque
$t_2 = 6\text{ s}$	T_{n2} : braking torque
$T_{n1} = T_n$	T_n : nominal torque
$T_{n2} = 1.65 \times T_n$	

References for a severe braking cycle (hoisting applications)

For drives	Degree of protection of the resistor	Ohmic value at 20 °C/ 68 °F	Average power available at 50 °C/ 122 °F (1)	Quantity required per drive	Reference	Weight
		Ω	kW			kg/lb
Supply voltage: 200...240 V or 380...480 V 50/60 Hz						
ATV930U07M3	IP20	100	0.26	1	VW3A7740	2.500/ 5.512
ATV930U15M3	IP20	60	0.5	1	VW3A7741	4.500/ 9.921
ATV930U22M3	IP20	60	3.4	1	VW3A7751	10.000/ 22.046
ATV930U30M3	IP20	28	1.1	1	VW3A7742	4.000/ 8.818
ATV930U55M3	IP20	16	2.2	1	VW3A7743	7.000/ 15.432
ATV930D11M3	IP20	10	3.4	1	VW3A7744	11.500/ 25.353
ATV930D18M3	IP23	5	6.9	1	VW3A7746	27.000/ 59.524
ATV930U07N4...U40N4 ATV950U07N4...U40N4 ATV950U07N4E...U40N4E	IP20	100	1.7	1	VW3A7750	5.500/ 12.125
ATV930U55N4...U75N4 ATV950U55N4...U75N4 ATV950U55N4E...U75N4E	IP20	60	3.4	1	VW3A7751	10.000/ 22.046
ATV930U40M3 ATV930D11N4...D15N4 ATV950D11N4...D15N4 ATV950D11N4E...D15N4E	IP23	28	5.1	1	VW3A7752	25.000/ 55.116
ATV930U75M3 ATV930D18N4...D30N4 ATV950D18N4...D30N4 ATV950D18N4E...D30N4E	IP23	16	14	1	VW3A7753	47.000/ 103.617
ATV930D37N4...D45N4 ATV950D37N4...D45N4 ATV950D37N4E...D45N4E	IP23	10	19	1	VW3A7754	67.000/ 147.710
ATV930D90N4 ATV950D90N4 ATV950D90N4E	IP23	10	19	2		
ATV930D15M3 ATV930D55N4 ATV950D55N4 ATV950D55N4E	IP23	8	25	1	VW3A7755	86.000/ 189.597
ATV930D22M3 ATV930D75N4 ATV950D75N4 ATV950D75N4E	IP23	5	32	1	VW3A7756	126.000/ 277.782
ATV930D30M3...D45M3 ATV930C11N4C...C16N4C	IP23	5	32	2		
ATV930C22N4 ATV930C25N4C	IP23	5	32	3		
ATV930C31N4C	IP23	5	32	4		
ATV930D55M3C...D75M3C	IP23	1.4	29	1	VW3A7757	114.000/ 251.327

(1) Load factor for resistors: The value of the average power that can be dissipated at 50 °C/122 °C from the resistor into the casing is determined for a load factor during braking that corresponds to the majority of normal applications:

- Heavy duty: 54 s braking with a 1 T_n braking torque and 6 s braking with a 1.65 T_n braking torque for a 120 s cycle

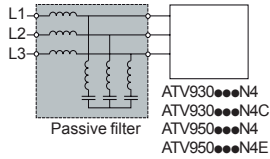

Presentation

Passive filters are used to obtain total harmonic distortion of less than 10% or 5%.
Reactive power increases at no load or low load. To help reduce this reactive power, the filter capacitors can be disconnected (see the diagrams on our website www.schneider-electric.com).
Passive filters provide IP 20 protection.

Applications

Reduction of current harmonics in order to use drives in the first environment (restricted distribution, domestic applications, sale conditional on the competence of the user and the distributor in terms of reducing current harmonics).



Passive filters: 400 V 50 Hz three-phase supply

Motor rating		For Altivar Process drives	Filter Nominal current		Quantity required per drive	Reference (1)	Weight
kW	HP		input A	output A			
THDI < 10%							
0.75	1	ATV930U07N4 ATV950U07N4 ATV950U07N4E	6	6.2	1	VW3A46101	12.000/ 26.455
1.5	2	ATV930U15N4 ATV950U15N4 ATV950U15N4E					
2.2	3	ATV930U22N4 ATV950U22N4 ATV950U22N4E					
3	–	ATV930U30N4 ATV950U30N4 ATV950U30N4E					
4	5	ATV930U40N4 ATV950U40N4 ATV950U40N4E	10	10.4	1	VW3A46102	13.500/ 29.762
5.5	7.5	ATV930U55N4 ATV950U55N4 ATV950U55N4E					
7.5	10	ATV930U75N4 ATV950U75N4 ATV950U75N4E	14	14.5	1	VW3A46103	16.300/ 35.935
11	15	ATV930D11N4 ATV950D11N4 ATV950D11N4E	22	23	1	VW3A46104	22.000/ 48.502
15	20	ATV930D15N4 ATV950D15N4 ATV950D15N4E	29	30	1	VW3A46105	25.000/ 55.116
18.5	25	ATV930D18N4 ATV950D18N4 ATV950D18N4E	35	37	1	VW3A46106	37.000/ 81.571
22	30	ATV930D22N4 ATV950D22N4 ATV950D22N4E	43	45	1	VW3A46107	39.000/ 85.980
30	40	ATV930D30N4 ATV950D30N4 ATV950D30N4E	58	60	1	VW3A46108	44.000/ 97.003
37	50	ATV930D37N4 ATV950D37N4 ATV950D37N4E	72	75	1	VW3A46109	56.000/ 123.459
45	60	ATV930D45N4 ATV950D45N4 ATV950D45N4E	86	90	1	VW3A46110	62.000/ 136.686
55	75	ATV930D55N4 ATV930D55N4C ATV950D55N4 ATV950D55N4E	101	105	1	VW3A46111	74.000/ 163.142
75	100	ATV930D75N4 ATV930D75N4C ATV950D75N4 ATV950D75N4E	144	150	1	VW3A46112	85.000/ 187.393
90	125	ATV930D90N4 ATV930D90N4C ATV950D90N4 ATV950D90N4E	180	187	1	VW3A46113	102.000/ 224.871

(1) When used with ATV950U07N4/N4E...D90N4/N4E drives, the filter must be mounted in a separate enclosure to maintain IP 55 protection for the installation.

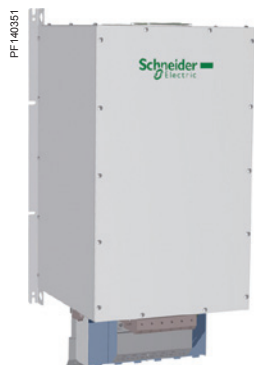

VW3A46116

Passive filters: 400 V 50 Hz three-phase supply							
Motor rating		For Altivar Process drives	Filter		Quantity required per drive	Reference	Weight
kW	HP		Nominal current input	output			
			A	A			kg/ lb
THDI < 10% (continued)							
110	150	ATV930C11N4C	217	225	1	VW3A46114	119.000/ 262.350
132	200	ATV930C13N4C	252	262	1	VW3A46115	136.000/ 299.828
160	250	ATV930C16N4C	304	316	1	VW3A46116	142.000/ 313.056
220	350	ATV930C22N4 ATV930C22N4C	380	395	1	VW3A46118	185.000/ 407.855
250	400	ATV930C25N4C	433	450	1	VW3A46119	203.000/ 447.538
315	500	ATV930C31N4C	304	316	2	VW3A46116	142.000/ 313.056

Variable speed drives

Altivar Process ATV900

Option: Passive filters



VW3A46126

Passive filters: 400 V 50 Hz three-phase supply							
Motor rating		For Altivar Process drives	Filter		Quantity required per drive	Reference (1)	Weight
kW	HP		Nominal current input	Nominal current output			
			A	A			kg/lb
THDI < 5%							
0.75	1	ATV930U07N4 ATV950U07N4 ATV950U07N4E	6	6.2	1	VW3A46120	16.000/ 35.274
1.5	2	ATV930U15N4 ATV950U15N4 ATV950U15N4E					
2.2	3	ATV930U22N4 ATV950U22N4 ATV950U22N4E					
3	–	ATV930U30N4 ATV950U30N4 ATV950U30N4E					
4	5	ATV930U40N4 ATV950U40N4 ATV950U40N4E	10	10.4	1	VW3A46121	18.000/ 39.683
5.5	7.5	ATV930U55N4 ATV950U55N4 ATV950U55N4E					
7.5	10	ATV930U75N4 ATV950U75N4 ATV950U75N4E	14	14.5	1	VW3A46122	20.000/ 44.092
11	15	ATV930D11N4 ATV950D11N4 ATV950D11N4E	22	23	1	VW3A46123	30.000/ 66.139
15	20	ATV930D15N4 ATV950D15N4 ATV950D15N4E	29	30	1	VW3A46124	34.000/ 74.957
18.5	25	ATV930D18N4 ATV950D18N4 ATV950D18N4E	35	37	1	VW3A46125	53.000/ 116.845
22	30	ATV930D22N4 ATV950D22N4 ATV950D22N4E	43	45	1	VW3A46126	58.000/ 127.868
30	40	ATV930D30N4 ATV950D30N4 ATV950D30N4E	58	60	1	VW3A46127	76.000/ 167.551
37	50	ATV930D37N4 ATV950D37N4 ATV950D37N4E	72	75	1	VW3A46128	98.000/ 216.053
45	60	ATV930D45N4 ATV950D45N4 ATV950D45N4E	86	90	1	VW3A46129	104.000/ 229.281
55	75	ATV930D55N4 ATV930D55N4C ATV950D55N4 ATV950D55N4E	101	105	1	VW3A46130	106.000/ 233.690
75	100	ATV930D75N4 ATV930D75N4C ATV950D75N4 ATV950D75N4E	144	150	1	VW3A46131	126.000/ 277.782
90	125	ATV930D90N4 ATV930D90N4C ATV950D90N4 ATV950D90N4E	180	187	1	VW3A46132	135.000/ 297.623

(1) When used with ATV950U07N4/N4E...D90N4/N4E drives, the filter must be mounted in a separate enclosure to maintain IP 55 protection for the installation.



VW3A46135

Passive filters: 400 V 50 Hz three-phase supply

Motor rating		For Altivar Process drives	Filter		Quantity required per drive	Reference	Weight
kW	HP		Nominal current				
			input	output			kg/ lb
			A	A			
THDI < 5% (continued)							
110	150	ATV930C11N4C	217	225	1	VW3A46133	172.000/ 379.195
132	200	ATV930C13N4C	252	262	1	VW3A46134	206.000/ 454.152
160	250	ATV930C16N4C	304	316	1	VW3A46135	221.000/ 487.221
220	350	ATV930C22N4 ATV930C22N4C	380	395	1	VW3A46137	265.000/ 584.225
250	400	ATV930C25N4C	433	450	1	VW3A46138	272.000/ 599.657
315	500	ATV930C31N4C	304	316	2	VW3A46135	221.000/ 487.222

Variable speed drives

Altivar Process ATV900

Option: Passive filters



VW3A46144

Passive filters: 460 V 60 Hz three-phase supply							
Motor rating		For Altivar Process drives	Filter		Quantity required per drive	Reference (1)	Weight
kW	HP		Nominal current input	Nominal current output			
			A	A			kg/lb
THDI < 10%							
0.75	1	ATV930U07N4 ATV950U07N4 ATV950U07N4E	6	6.2	1	VW3A46139	12.000/ 26.455
1.5	2	ATV930U15N4 ATV950U15N4 ATV950U15N4E					
2.2	3	ATV930U22N4 ATV950U22N4 ATV950U22N4E					
3	–	ATV930U30N4 ATV950U30N4 ATV950U30N4E					
4	5	ATV930U40N4 ATV950U40N4 ATV950U40N4E	10	10.4	1	VW3A46140	13.500/ 29.762
5.5	7.5	ATV930U55N4 ATV950U55N4 ATV950U55N4E					
7.5	10	ATV930U75N4 ATV950U75N4 ATV950U75N4E	14	14.5	1	VW3A46141	16.300/ 35.935
11	15	ATV930D11N4 ATV950D11N4 ATV950D11N4E	19	19.5	1	VW3A46142	22.000/ 48.502
15	20	ATV930D15N4 ATV950D15N4 ATV950D15N4E	25	26	1	VW3A46143	23.000/ 50.706
18.5	25	ATV930D18N4 ATV950D18N4 ATV950D18N4E	31	32	1	VW3A46144	33.000/ 72.752
22	30	ATV930D22N4 ATV950D22N4 ATV950D22N4E	36	37	1	VW3A46145	37.000/ 81.571
30	40	ATV930D30N4 ATV950D30N4 ATV950D30N4E	48	50	1	VW3A46146	39.000/ 85.980
37	50	ATV930D37N4 ATV950D37N4 ATV950D37N4E	60	62	1	VW3A46147	43.000/ 94.799
45	60	ATV930D45N4 ATV950D45N4 ATV950D45N4E	73	76	1	VW3A46148	55.000/ 121.254
55	75	ATV930D55N4 ATV930D55N4C ATV950D55N4 ATV950D55N4E	95	99	1	VW3A46149	62.000/ 136.686
75	100	ATV930D75N4 ATV930D75N4C ATV950D75N4 ATV950D75N4E	118	122	1	VW3A46150	74.000/ 163.142
90	125	ATV930D90N4 ATV930D90N4C ATV950D90N4 ATV950D90N4E	154	160	1	VW3A46151	85.000/ 187.393
110	150	ATV930C11N4C	183	190	1	VW3A46152	102.000/ 224.871
132	200	ATV930C13N4C	231	240	1	VW3A46153	119.000/ 262.350
160	250	ATV930C16N4C	291	302.5	1	VW3A46154	142.000/ 313.056
220	350	ATV930C22N4 ATV930C22N4C	355	369	1	VW3A46155	162.000/ 357.149
250	400	ATV930C25N4C	436	450	2	VW3A46157	205.000/ 451.948
315	500	ATV930C31N4C	231	240	2	VW3A46153	119.000/ 262.350

(1) When used with ATV950U07N4/N4E...D90N4/N4E drives, the filter must be mounted in a separate enclosure to maintain IP 55 protection for the installation.



VW3A46164

Passive filters: 460 V 60 Hz three-phase supply

Motor rating	For Altivar Process drives	Filter	Nominal current		Quantity required per drive	Reference (1)	Weight
			input	output			
kW	HP		A	A			kg/lb
THDI < 5%							
0.75	1	ATV930U07N4 ATV950U07N4 ATV950U07N4E	6	6.2	1	VW3A46158	16.000/ 35.274
1.5	2	ATV930U15N4 ATV950U15N4 ATV950U15N4E					
2.2	3	ATV930U22N4 ATV950U22N4 ATV950U22N4E					
3	–	ATV930U30N4 ATV950U30N4 ATV950U30N4E					
4	5	ATV930U40N4 ATV950U40N4 ATV950U40N4E	10	10.4	1	VW3A46159	18.000/ 39.683
5.5	7.5	ATV930U55N4 ATV950U55N4 ATV950U55N4E					
7.5	10	ATV930U75N4 ATV950U75N4 ATV950U75N4E	14	14.5	1	VW3A46160	20.000/ 44.092
11	15	ATV930D11N4 ATV950D11N4 ATV950D11N4E	19	19.5	1	VW3A46161	30.000/ 66.139
15	20	ATV930D15N4 ATV950D15N4 ATV950D15N4E	25	26	1	VW3A46162	34.000/ 74.957
18.5	25	ATV930D18N4 ATV950D18N4 ATV950D18N4E	31	32	1	VW3A46163	52.000/ 114.640
22	30	ATV930D22N4 ATV950D22N4 ATV950D22N4E	36	37	1	VW3A46164	53.000/ 116.845
30	40	ATV930D30N4 ATV950D30N4 ATV950D30N4E	48	50	1	VW3A46165	57.000/ 125.663
37	50	ATV930D37N4 ATV950D37N4 ATV950D37N4E	60	62	1	VW3A46166	75.000/ 165.347
45	60	ATV930D45N4 ATV950D45N4 ATV950D45N4E	73	76	1	VW3A46167	97.000/ 213.848
55	75	ATV930D55N4 ATV930D55N4C ATV950D55N4 ATV950D55N4E	95	99	1	VW3A46168	104.000/ 229.281
75	100	ATV930D75N4 ATV930D75N4C ATV950D75N4 ATV950D75N4E	118	122	1	VW3A46169	106.000/ 233.690
90	125	ATV930D90N4 ATV930D90N4C ATV950D90N4 ATV950D90N4E	154	160	1	VW3A46170	126.000/ 277.782
110	150	ATV930C11N4C	183	190	1	VW3A46171	135.000/ 297.624
132	200	ATV930C13N4C	231	240	1	VW3A46172	170.000/ 374.786
160	250	ATV930C16N4C	291	316	1	VW3A46173	221.000/ 487.221
220	350	ATV930C22N4 ATV930C22N4C	355	369	1	VW3A46174	229.000/ 504.859
250	400	ATV930C25N4C	436	450	1	VW3A46176	270.000/ 595.248
315	500	ATV930C31N4C	231	240	2	VW3A46172	170.000/ 374.786

(1) When used with ATV950U07N4/N4E...D90N4/N4E drives, the filter must be mounted in a separate enclosure to maintain IP 55 protection for the installation.

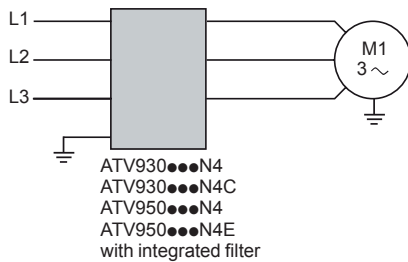

Altivar Process drive with integrated EMC filter

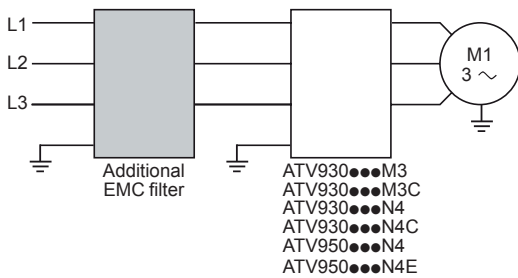

Altivar Process drive with additional EMC filter

Integrated EMC filters

Altivar Process drives (except ATV930...M3/M3C) have integrated radio interference input filters in accordance with the EMC standard for variable speed electrical power drive "products" IEC/EN 61800-3, edition 2, category C2 or C3 in environment 1 or 2, and to comply with the European EMC (electromagnetic compatibility) directive.

The integrated EMC filter runs off the leakage current to ground. The leakage current can be reduced by disconnecting the filter capacitors (please refer to the installation guide on our website www.schneider-electric.com). In this configuration, the product does not comply with the European EMC directive.

For drives	Maximum length of shielded cable (1) acc. to	
	IEC/EN 61800-3 category C2	IEC/EN 61800-3 category C3
	m	m
Three-phase supply voltage: 380...480 V IP 21		
ATV930U07N4... D45N4	50	150
ATV930D55N4/N4C...D90N4/N4C	–	150
ATV930C11N4C...C16N4C		
ATV930C22N4	–	50
ATV930C22N4C...C31N4C		
Three-phase supply voltage: 380...480 V IP 55		
ATV950U07N4/N4E...D45N4/N4E	50	150
ATV950D55N4/N4E...D90N4/N4E	–	150

Additional EMC input filters

Additional EMC input filters can be used to meet more stringent requirements and are designed to reduce conducted emissions on the line supply below the limits of standard IEC/EN 61800-3 category C1, C2 or C3.

Use according to the type of line supply

Use of these additional filters is only possible on TN (neutral connection) and TT (grounded neutral) type systems.

Standard IEC/EN 61800-3, appendix D2.1, states that on IT systems (isolated or impedance grounded neutral), filters can cause permanent insulation monitors to operate in a random manner.

If a machine needs to be installed on an IT system, one solution is to insert an isolation transformer and connect the machine locally to a TN or TT system.

References

For drives	Maximum length of shielded cable (1)		In (2)	If	Reference	Weight
	IEC/EN 61800-3 category C2 (3)	IEC/EN 61800-3 category C3 (3)				
	m	m	A	mA		kg/ lb
Three-phase supply voltage: 200...240 V 50 Hz						
ATV930U07M3...U15M3	50	150	8	7.6	VW3A4701	2.000/ 4.409
ATV930U22M3...U30M3	50	150	15	7.6	VW3A4702	2.400/ 5.291
ATV930U40M3...U75M3	50	150	35	7.6	VW3A4703	4.100/ 9.039
ATV930D11M3	50	150	50	7.6	VW3A4704	5.200/ 11.464
ATV930D15M3	50	150	70	13.9	VW3A4705	6.100/ 13.448
ATV930D18M3...D22M3	50	150	100	13.9	VW3A4706	6.500/ 14.330
ATV930D30M3...D37M3	50	150	160	13.9	VW3A4707	8.500/ 18.739
ATV930D30M3C...D37M3C						
ATV930D45M3	50	150	200	13.9	VW3A4708	9.500/ 20.944
ATV930D45M3C						
ATV930D55M3C	50	150	240	27.8	VW3A4709	15.000/ 33.069
ATV930D75M3C	50	150	305	27.8	VW3A4710	17.000/ 37.479

(1) The maximum lengths are given as examples only, as they vary depending on the stray capacitance of the motors and the cables used. If motors are connected in parallel, it is the total length of all cables that should be taken into account.

(2) Nominal filter current.

(3) Values given depend on the nominal switching frequency of the drive. This frequency depends on the drive rating.



VW3A4703

Additional EMC input filters (continued)						
References (continued)						
For drives	Maximum length of shielded cable (1) (2)		In (4)	If	Reference (5)	Weight
	IEC/EN 61800-3 category C2 (3)	IEC/EN 61800-3 category C3 (3)				
	m	m	A	mA		kg/ lb
Three-phase supply voltage: 380...480 V 50 Hz						
ATV930U07N4...U22N4 ATV950U07N4...U22N4 ATV950U07N4E...U22N4E	150	300	8	7.6	VW3A4701	2.000/ 4.409
ATV930U30N4...U55N4 ATV950U30N4...U55N4 ATV950U30N4E...U55N4E	150	300	15	7.6	VW3A4702	2.400/ 5.291
ATV930U75N4...D15N4 ATV950U75N4...D15N4 ATV950U75N4E...D15N4E	150	300	35	7.6	VW3A4703	4.100/ 9.039
ATV930D18N4...D22N4 ATV950D18N4...D22N4 ATV950D18N4E...D22N4E	150	300	50	7.6	VW3A4704	5.200/ 11.464
ATV930D30N4 ATV950D30N4 ATV950D30N4E	150	300	70	13.9	VW3A4705	6.100/ 13.448
ATV930D37N4...D45N4 ATV950D37N4...D45N4 ATV950D37N4E...D45N4E	150	300	100	13.9	VW3A4706	6.500/ 14.330
ATV930D55N4 ATV930D55N4C ATV950D55N4 ATV950D55N4E	150	300	160	13.9	VW3A4707	8.500/ 18.739
ATV930D75N4...D90N4 ATV930D75N4C...D90N4C ATV950D75N4...D90N4 ATV950D75N4E...D90N4E	150	300	200	13.9	VW3A4708	9.500/ 20.944
ATV930C11N4C ATV930C13N4C	150	300	240	27.8	VW3A4709	15.000/ 33.069
ATV930C16N4C	150	300	305	27.8	VW3A4710	17.000/ 37.479
ATV930C22N4 ATV930C22N4C...C31N4C	300	–	546	599	VW3A4411	25.000/ 55.116

IP 21 protection kit for IP 20 filters

Additional input filters provide IP 20 protection as standard. This kit can be used to provide IP 21 or UL type 1 protection.

Description	For filters	Reference	Weight kg/ lb
Mechanical kit including cover and cable clamps	VW3A4701	VW3A47901	0.200/ 0.441
	VW3A4702	VW3A47902	0.300/ 0.661
	VW3A4703	VW3A47903	0.400/ 0.882
	VW3A4704	VW3A47904	0.500/ 1.102
	VW3A4705	VW3A47905	0.900/ 1.984
	VW3A4706	VW3A47906	1.000/ 2.205
	VW3A4707	VW3A47907	1.500/ 3.307
	VW3A4708	VW3A47908	2.000/ 4.409

(1) The maximum lengths are given as examples only, as they vary depending on the stray capacitance of the motors and the cables used. If motors are connected in parallel, it is the total length of all cables that should be taken into account.

(2) The associations of EMC filters with **ATV900U07N4/N4E...D22N4/N4E**, **ATV930C22N4** and **ATV930C22N4C...C31N4C** drives are also compliant with the IEC/EN 61800-3 category C1 standard with a 50 m shielded cable length.

(3) Values given depend on the nominal switching frequency of the drive. This frequency depends on the drive rating.

(4) Nominal filter current.

(5) When used with **ATV950U07N4/N4E...D90N4/N4E** drives, the filter must be mounted in a separate enclosure to maintain IP 55 protection for the installation.

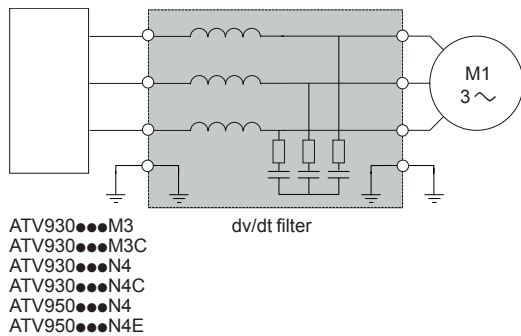

Altivar Process drive with dv/dt filter

Presentation

Altivar Process drives operate with the following maximum motor cable lengths: 150 m/492 ft for shielded cables and 300 m/984 ft for unshielded cables.

The output voltage delivered by a drive based on PWM (Pulse Width Modulation) is a series of pulses.

When applied to the motor, unexpected phenomena occur, such as overvoltages across the motor windings and high frequency currents flowing through the leakage capacitors of the cable and windings.

To limit overvoltages in the motor, it is recommended, for cables longer than 50 m/164 ft, that you check the motor insulation type and add an output filter if necessary.

For further information, please consult the White Paper "An Improved Approach for Connecting VSD and Electric Motors" available on our website www.schneider-electric.com.

Output filters are used to limit dv/dt at the motor terminals to 500 V/μs maximum.

Output filters are designed to limit overvoltages at the motor terminals to less than:

- 800 V with a shielded cable 0 to 50 m (0 to 164 ft) long, with a 400 V supply voltage
- 1,000 V with a shielded cable 50 to 150 m (164 to 492 ft) long, with a 400 V supply voltage
- 1,500 V with a shielded cable 150 to 300 m (492 to 984 ft) long, with a 400 V supply voltage (up to 500 m (16,400 ft) with an unshielded cable)

They are also used to:

- Limit overvoltages at the motor terminals
- Filter interference caused by opening a contactor placed between the filter and the motor

The performance of dv/dt filters will be affected if the maximum cable lengths are exceeded. For an application with several motors connected in parallel, the cable length must include all cabling. If a cable longer than that recommended is used, the dv/dt filters may overheat.

The switching frequency must be under 8 kHz.

dv/dt output filters

For drives	Maximum length of motor cable		Degree of protection	In (3)	Reference	Weight
	Maximum switching frequency (1)	Shielded cable (2)				
	kHz	m/ft	IP	A		kg/lb
Three-phase supply voltage: 200...240 V						
ATV930U07M3	4	300/ 984	20	6	VW3A5301	11.000/ 24.251
ATV930U15M3...U30M3	4	300/ 984	20	15	VW3A5302	12.000/ 26.455
ATV930U40M3	4	300/ 984	20	25	VW3A5303	12.000/ 26.455
ATV930U55M3...D11M3	4	300/ 984	20	50	VW3A5304	18.000/ 39.683
ATV930D15M3...D22M3	4	300/ 984	20	95	VW3A5305	19.000/ 41.888
ATV930D30M3...D45M3 ATV930D30M3C...D45M3C	2.5	300/ 984	00	180	VW3A5306	22.000/ 48.502
ATV930D55M3C...D75M3C	2.5	300/ 984	00	305	VW3A5307	40.000/ 88.185

(1) The filters are designed to operate in a switching frequency range of between 2 and 8 kHz.

(2) Values given depend on the nominal switching frequency of the drive. This frequency depends on the drive rating. These cable lengths are given as examples only as they can vary depending on the application. They correspond to motors conforming to IEC 6034-25 and NEMA MG1/31.2006.

(3) Nominal filter current.

Variable speed drives

Altivar Process ATV900: Output filters

Option: dv/dt filters

PF40386A



VW3A5304

dv/dt output filters (continued)

For drives	Maximum length of motor cable		Degree of protection (3)	In (4)	Reference (4)	Weight
	Maximum switching frequency (1)	Shielded cable (2)				
	kHz	m/ft	IP	A		kg/lb
Three-phase supply voltage: 380...480 V						
ATV930U07N4...U22N4 ATV950U07N4...U22N4 ATV950U07N4E...U22N4E	4	300/ 984	20	6	VW3A5301	11.000/ 24.251
ATV930U30N4...U55N4 ATV950U30N4...U55N4 ATV950U30N4E...U55N4E	4	300/ 984	20	15	VW3A5302	12.000/ 26.455
ATV930U75N4...D11N4 ATV950U75N4...D11N4 ATV950U75N4E...D11N4E	4	300/ 984	20	25	VW3A5303	12.000/ 26.455
ATV930D15N4...D22N4 ATV950D15N4...D22N4 ATV950D15N4E...D22N4E	4	300/ 984	20	50	VW3A5304	18.000/ 39.683
ATV930D30N4...D45N4 ATV950D30N4...D45N4 ATV950D30N4E...D45N4E	4	300/ 984	20	95	VW3A5305	19.000/ 41.888
ATV930D55N4...D90N4 ATV930D55N4C...D90N4C ATV950D55N4...D90N4 ATV950D55N4E...D90N4E	2.5	300/ 984	00	180	VW3A5306	22.000/ 48.502
ATV930C11N4C...C16N4C	2.5	300/ 984	00	305	VW3A5307	40.000/ 88.185
ATV930C22N4 ATV930C22N4C	2.5	250/ 820	00	481	VW3A5106	58.000/ 127.868
ATV930C25N4C...C31N4C	2.5	200/ 656	00	759	VW3A5107	93.000/ 205.030

IP 21 protection kit for IP 20 filters

Description	For dv/dt filters	Reference	Weight kg/lb
Mechanical kit including cover and cable clamps	VW3A5301 VW3A5302 VW3A5303	VW3A53902	1.300/ 2.866
	VW3A5304	VW3A53903	1.700/ 3.748
	VW3A5305	VW3A53905	3.200/ 7.055

(1) The filters are designed to operate in a switching frequency range of between 2 and 8 kHz.

(2) Values given depend on the nominal switching frequency of the drive. This frequency depends on the drive rating. These cable lengths are given as examples only as they can vary depending on the application. They correspond to motors conforming to IEC 6034-25 and NEMA MG1/31.2006.

(3) Nominal filter current.

(4) When used with **ATV950U07N4/N4E...D90N4/N4E** drives, the filter must be mounted in a separate enclosure to maintain IP 55 protection for the installation.

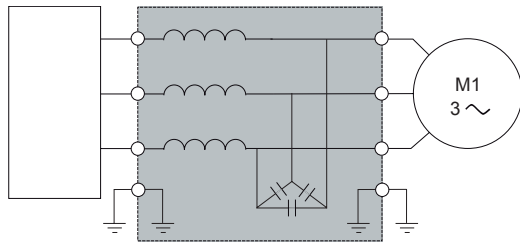

ATV930●●●M3
ATV930●●●M3C
ATV930●●●N4
ATV930●●●N4C
ATV950●●●N4
ATV950●●●N4E

Sinus filter

Altivar Process drive with sinus filter

Presentation

Sinus filters allow Altivar Process drives to operate with long motor cables:

- 500 m (1,640 ft) with a shielded cable
- 1,000 m (3,280 ft) with an unshielded cable

The minimum switching frequency at which sinus filters can operate is 4 kHz. This is the default value when the sinus filter function is activated on the variable speed drive (please refer to the programming guide on our website www.schneider-electric.com).

The output frequency must be less than 100 Hz.

At 100% load, the voltage drop is less than 8% with output frequency 50 Hz and switching frequency 4 kHz.

Applications

For applications requiring:

- Long cable runs
- Motors connected in parallel
- Submersible pumps sensitive to dv/dt
- An intermediate transformer between the drive and the motor

Sinus filters

For drives	Nominal current A	Degree of protection IP	Reference (1)	Weight kg/ lb
Three-phase supply voltage: 200...240 V				
ATV930U07M3	6	20	VW3A5401	10.000/ 22.046
ATV930U15M3...U30M3	15	20	VW3A5402	13.500/ 29.762
ATV930U40M3	25	20	VW3A5403	20.000/ 44.092
ATV930U55M3...D11M3	50	20	VW3A5404	35.000/ 77.162
ATV930D15M3...D22M3	95	20	VW3A5405	60.000/ 132.277
ATV930D30M3...D45M3 ATV930D30M3C...D45M3C	180	00	VW3A5406	90.000/ 198.416
ATV930D75M3C (2)	305	00	VW3A5407	134.000/ 295.419

(1) The filters are designed to operate in a switching frequency range of between 4 and 8 kHz.

(2) In "Normal duty", apply a derating of Pn-1 to the drive nominal power with a minimum switching frequency of 4 kHz.

For example: An ATV930D75M3C drive with sinus filter can be used on a 55 kW motor.

Variable speed drives

Altivar Process ATV900: Output filters

Option: Sinus filters

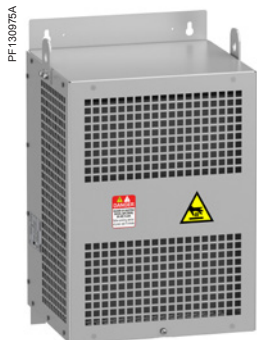

VW3A5404

Sinus filters (continued)

For drives	Nominal current	Degree of protection	Reference (1) (2)	Weight
	A	IP		kg/ lb
Three-phase supply voltage: 380...480 V				
ATV930U07N4...U22N4 ATV950U07N4...U22N4 ATV950U07N4E...U22N4E	6	20	VW3A5401	10.000/ 22.046
ATV930U30N4...U55N4 ATV950U30N4...U55N4 ATV950U30N4E...U55N4E	15	20	VW3A5402	13.500/ 29.762
ATV930U75N4...D11N4 ATV950U75N4...D11N4 ATV950U75N4E...D11N4E	25	20	VW3A5403	20.000/ 44.092
ATV930D15N4...D22N4 ATV950D15N4...D22N4 ATV950D15N4E...D22N4E	50	20	VW3A5404	35.000/ 77.162
ATV930D30N4...D45N4 ATV950D30N4...D45N4 ATV950D30N4E...D45N4E	95	20	VW3A5405	60.000/ 132.277
ATV930D55N4...D90N4 ATV930D55N4C...D90N4C ATV950D55N4...D90N4 ATV950D55N4E...D90N4E	180	00	VW3A5406	90.000/ 198.416
ATV930C13N4C...C16N4C (3)	305	00	VW3A5407	134.000/ 295.419
ATV930C22N4 (3) ATV930C22N4C (3)	400	00	VW3A5209	190.000/ 418.878
ATV930C25N4C...C31N4C (3)	600	00	VW3A5210	260.000/ 573.202

IP 21 protection kit for IP 20 filters

Description	For sinus filter	Reference	Weight
			kg/ lb
Mechanical kit including cover and cable clamps	VW3A5401 VW3A5402	VW3A53901	1.000/ 2.205
	VW3A5403	VW3A53902	1.300/ 2.866
	VW3A5404	VW3A53903	2.700/ 5.952
	VW3A5405	VW3A53904	3.200/ 7.055

(1) The filters are designed to operate in a switching frequency range of between 4 and 8 kHz.

(2) When used with **ATV950U07N4/N4E...D90N4/N4E** drives, the filter must be mounted in a separate enclosure to maintain IP 55 protection for the installation.

(3) In "Normal Duty", apply a derating of Pn-1 to the drive nominal power with a minimum switching frequency of 4 kHz. For example:

An ATV930C13N4C drive with sinus filter can be used on a 110 kW motor.

An ATV930C16N4C drive with sinus filter can be used on a 132 kW motor.

Variable speed drives

Altivar Process ATV900: Output filters

Option: Common mode filters

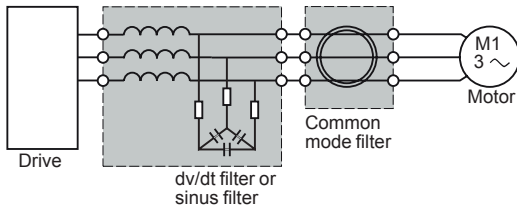

Altivar Process ATV900 drive with common mode filter

Presentation

Sinus filters or dv/dt filters reduce the overvoltage across windings and high frequency currents in differential mode. But they have no effect on the common mode current between phases and the cable shielding, and between the windings and the stator/rotor of the motor.

Common mode filters bring several benefits:

- Reduction of RFI (Radio Frequency Interference) of the motor cable and improvement of the effectiveness of the EMC filter for conducted emissions
- Reduction of the high frequency currents circulating in the bearings of the motor and prevention of their damage.

It is possible to use the common mode filter at the output terminals of the drive, the dv/dt filter, or the sinus filter.

Note: The selection of a common mode configuration depends on the type and length of motor cable. An abnormal increase of the temperature indicates a possible saturation. Additional filters shall be used to avoid it.

Common mode filters

For drives	Maximum length of unshielded cable			
	150 m/ 492.12 ft	300 m/ 984.25 ft	500 m/ 1,640.42 ft	1,000 m/ 3,280.83 ft
ATV930U07M3...U40M3	VW3A5501	VW3A5502	2 x VW3A5501	VW3A5501 + VW3A5502
ATV930U55M3	VW3A5501	VW3A5502	VW3A5501 + VW3A5502	2 x VW3A5502
ATV930U75M3...D11M3	VW3A5503	VW3A5504	2 x VW3A5503	VW3A5503 + VW3A5504
ATV930D15M3...D22M3	VW3A5503	VW3A5504	VW3A5503 + VW3A5504	2 x VW3A5504
ATV930D30M3...D45M3 ATV930D30M3C...D45M3C	VW3A5503	VW3A5504	VW3A5503 + VW3A5504	2 x VW3A5504
ATV930D55M3C...D75M3C	VW3A5505	VW3A5506	VW3A5505 + VW3A5506	VW3A5506

PF130952A

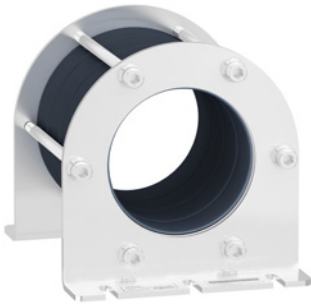

VW3A5503

Common mode filters (continued)

For drives	Maximum length of unshielded cable			
	150 m/ 492.12 ft	300 m/ 984.25 ft	500 m/ 1,640.42 ft	1,000 m/ 3,280.83 ft
ATV930U07N4...U40N4 ATV950U07N4...U40N4 ATV950U07N4E...U40N4E	VW3A5501	VW3A5502	2 x VW3A5501	VW3A5501 + VW3A5502
ATV930U55N4 ATV950U55N4 ATV950U55N4E	VW3A5501	VW3A5502	VW3A5501 + VW3A5502	VW3A5501 + VW3A5502
ATV930U75N4...D11N4 ATV950U75N4...D11N4 ATV950U75N4E...D11N4E	VW3A5501	VW3A5502	VW3A5501 + VW3A5502	2 x VW3A5502
ATV930D15N4...D22N4 ATV950D15N4...D22N4 ATV950D15N4E...D22N4E	VW3A5503	VW3A5504	2 x VW3A5503	VW3A5503 + VW3A5504
ATV930D30N4...D90N4 ATV930D55N4C...D90N4C ATV950D30N4...D90N4 ATV950D30N4E...D90N4E	VW3A5503	VW3A5504	VW3A5503 + VW3A5504	2 x VW3A5504
ATV930C11N4C...C16N4C	VW3A5505	VW3A5506	2 x VW3A5505	2 x VW3A5506

For drives	Maximum length of shielded cable		
	150 m/ 492.12 ft	300 m/ 984.25 ft	500 m/ 1,640.42 ft
ATV930U07N4...U40N4 ATV950U07N4...U40N4 ATV950U07N4E...U40N4E	VW3A5501	VW3A5502	2 x VW3A5501
ATV930U55N4 ATV950U55N4 ATV950U55N4E	VW3A5502	2 x VW3A5501	2 x VW3A5502
ATV930U75N4...D11N4 ATV950U75N4...D11N4 ATV950U75N4E...D11N4E	VW3A5502	2 x VW3A5501	2 x VW3A5502
ATV930D15N4...D22N4 ATV950D15N4...D22N4 ATV950D15N4E...D22N4E	VW3A5503	2 x VW3A5503	VW3A5503 + VW3A5504
ATV930D30N4...D90N4 ATV930D55N4C...D90N4C ATV950D30N4...D90N4 ATV950D30N4E...D90N4E	VW3A5504	VW3A5503 + VW3A5504	2 x VW3A5504
ATV930C11N4C	VW3A5505	VW3A5506	VW3A5505 + VW3A5506
ATV930C13N4C...C16N4C	VW3A5506	2 x VW3A5505	2 x VW3A5506

Applications

Circuit breaker/contactors/drive combinations help to ensure continuity of service in the installation.

The type of circuit breaker/contactors coordination selected can reduce maintenance costs in the event of a short-circuit on the drive input by minimizing the time required to make the necessary repairs and the cost of replacement equipment. The suggested combinations provide coordination according to the drive rating.

The drive controls the motor, provides a monitoring function against short-circuits between the drive and the motor, and helps protect the motor cable against overloads. Overload monitoring is provided by the drive's motor thermal monitoring function if this has been enabled. Otherwise, an external monitoring device such as a probe or thermal overload relay should be provided.

The circuit breaker helps protect the drive's power cables against short-circuits.

IEC standard motor starters

Motor	Drive	Circuit breaker			Line contactor	
Power (1)	Reference	Reference (2)	Rating	I _{rm}	Reference (3) (4)	
kW	HP		A	A		
Three-phase supply voltage: 200...240 V 50/60 Hz						
0.75	1	ATV930U07M3	GV2L08	4	51	LC1D09●●
1.5	2	ATV930U15M3	GV2L10	6.3	78	LC1D09●●
2.2	3	ATV930U22M3	GV2L14	10	138	LC1D09●●
3	–	ATV930U30M3	GV2L16	14	170	LC1D18●●
4	5	ATV930U40M3	GV2L20	18	223	LC1D18●●
5.5	7.5	ATV930U55M3	GV2L22	25	327	LC1D25●●
7.5	10	ATV930U75M3	GV2L32	32	448	LC1D40A●●
11	15	ATV930D11M3	GV3L40	40	560	LC1D40A●●
15	20	ATV930D15M3	GV3L65	65	910	LC1D65A●●
18.5	25	ATV930D18M3	NS80HMA	80	1000	LC1D65A●●
22	30	ATV930D22M3	NS80HMA	80	1000	LC1D80●●
30	40	ATV930D30M3	NSX100●MA100	100	1300	LC1D95●●
30	40	ATV930D30M3C	NSX100●MA100	100	1300	LC1D95●●
37	50	ATV930D37M3	NSX160●MA150	150	1500	LC1D115●●
37	50	ATV930D37M3C	NSX160●MA150	150	1500	LC1D115●●
45	60	ATV930D45M3	NSX160●MA150	150	1500	LC1D150●●
45	60	ATV930D45M3C	NSX160●MA150	150	1500	LC1D150●●
55	75	ATV930D55M3C	NSX250●MA220	220	2420	LC1F185●●
75	100	ATV930D75M3C	NSX400● Micrologic 1.3-M	320	3500	LC1F265●●

(1) Standard power ratings for 230 V 50/60 Hz 4-pole motors.

The values expressed in HP conform to the NEC (National Electrical Code).

(2) For references to be completed, replace the dot with the letter corresponding to the breaking performance of the circuit breaker (F, N, H, S or L).

Breaking capacity of circuit breakers according to standard IEC 60947-2:

Circuit breaker	I _{cu} (kA) for 200...240 V	Icu (kA) for 200...240 V				
		F	N	H	S	L
GV2L08...L20	100	–	–	–	–	–
GV2L32	50	–	–	–	–	–
GV3L40...L65	100	–	–	–	–	–
NS80HMA	100	–	–	–	–	–
NSX100●MA100	–	85	90	100	120	150
NSX160●MA150	–	85	90	100	120	150
NSX250●MA220	–	85	90	100	120	150
NSX400● Micrologic 1.3-M	–	40	85	100	120	150

(3) Composition of contactors:

LC1D09...D150: 3 poles + 1 NO auxiliary contact + 1 NC auxiliary contact

LC1F185...F265: 3 poles

To add auxiliary contacts or other accessories, please refer to the "Motor-starter solutions - Control and protection components" catalog.

(4) Replace ●● with the control circuit voltage code indicated in the table below:

	Volts ~	24	48	110	220	230	240
		LC1D09...D150	50 Hz	B5	E5	F5	M5
	60 Hz	B6	E6	F6	M6	–	U6
	50/60 Hz	B7	E7	F7	M7	P7	U7
LC1F185	50 Hz (LX1 coil)	B5	E5	F5	M5	P5	U5
	60 Hz (LX1 coil)	–	E6	F6	M6	–	U6
	40...400 Hz (LX9 coil)	–	E7	F7	M7	P7	U7
LC1F265	40...400 Hz (LX1 coil)	B7	E7	F7	M7	P7	U7

For other voltages available between 24 V and 660 V, or a DC control circuit, please contact our Customer Care Center.



GV3L40

+



LC1D40A●●

+



ATV930D11M3



NSX100FMA100

+



LC1D80●●

+



ATV930D45N4

IEC standard motor starters

Motor	Drive	Circuit breaker			Line contactor	
Power (1)	Reference	Reference (2)	Rating	I _{rm}	Reference (3) (4)	
kW	HP		A	A		
Three-phase supply voltage: 380...415 V 50/60 Hz						
0.75	1	ATV930U07N4	GV2L07	2.5	33.5	LC1D09●●
1.5	2	ATV930U15N4	GV2L08	4	51	LC1D09●●
2.2	3	ATV930U22N4	GV2L10	6.3	78	LC1D09●●
3	–	ATV930U30N4	GV2L14	10	138	LC1D09●●
4	5	ATV930U40N4	GV2L14	10	138	LC1D09●●
5.5	7.5	ATV930U55N4	GV2L16	14	170	LC1D18●●
7.5	10	ATV930U75N4	GV2L20	18	223	LC1D18●●
11	15	ATV930D11N4	GV2L22	25	327	LC1D25●●
15	20	ATV930D15N4	GV3L32	32	448	LC1D25●●
18.5	25	ATV930D18N4	GV3L40	40	560	LC1D40A●●
22	30	ATV930D22N4	GV3L50	50	700	LC1D50A●●
30	40	ATV930D30N4	GV3L65	65	910	LC1D50A●●
37	50	ATV930D37N4	NS80HMA	80	1000	LC1D65A●●
45	60	ATV930D45N4	NSX100●MA100	100	1300	LC1D80●●
55	75	ATV930D55N4	NSX160●MA150	150	1500	LC1D115●●
55	75	ATV930D55N4C	NSX160●MA150	150	1500	LC1D115●●
75	100	ATV930D75N4	NSX160●MA150	150	1500	LC1D115●●
75	100	ATV930D75N4C	NSX160●MA150	150	1500	LC1D115●●
90	125	ATV930D90N4	NSX250●MA220	220	2420	LC1F185●●
90	125	ATV930D90N4C	NSX250●MA220	220	2420	LC1F185●●
110	150	ATV930C11N4C	NSX250●MA220	220	2860	LC1F185●●
132	200	ATV930C13N4C	NSX400● Micrologic 1.3-M	320	3500	LC1F265●●
160	250	ATV930C16N4C	NSX400● Micrologic 1.3-M	320	4000	LC1F265●●
220	350	ATV930C22N4	NSX630● Micrologic 1.3-M	500	3 000	LC1F400●●
220	350	ATV930C22N4C	NSX630● Micrologic 1.3-M	500	3 000	LC1F400●●
250	400	ATV930C25N4C	NSX630● Micrologic 1.3-M	500	3 000	LC1F500●●
315	500	ATV930C31N4C	NS800L Micrologic 2 or 5	800	1 600	LC1F630●●

(1) Standard power ratings for 400 V 50/60 Hz 4-pole motors.

The values expressed in HP conform to the NEC (National Electrical Code).

(2) For references to be completed, replace the dot with the letter corresponding to the breaking performance of the circuit breaker (F, N, H, S or L). Breaking capacity of circuit breakers according to standard IEC 60947-2:

Circuit breaker	I _{cu} (kA) for 380...415 V					
	F	N	H	S	L	
GV2L07...L14	100	–	–	–	–	
GV2L16...L22	50	–	–	–	–	
GV3L32...L65	50	–	–	–	–	
NS80HMA	70	–	–	–	–	
NSX100●MA100	–	36	50	70	150	
NSX160●MA150	–	36	50	70	150	
NSX250●MA220	–	36	50	70	150	
NSX400●, NSX630●	–	36	50	70	150	
NS800L Micrologic 2 or 5	–	–	–	–	150	

(3) Composition of contactors:

LC1D09...D115: 3 poles + 1 NO auxiliary contact + 1 NC auxiliary contact

LC1F185...F265: 3 poles

To add auxiliary contacts or other accessories, please refer to the "Motor-starter solutions - Control and protection components" catalog.

(4) Replace ●● with the control circuit voltage code indicated in the table below:

	Volts ~	24	48	110	220	230	240
LC1D09...D115	50 Hz	B5	E5	F5	M5	P5	U5
	60 Hz	B6	E6	F6	M6	–	U6
	50/60 Hz	B7	E7	F7	M7	P7	U7
LC1F185	50 Hz (LX1 coil)	B5	E5	F5	M5	P5	U5
	60 Hz (LX1 coil)	–	E6	F6	M6	–	U6
	40...400 Hz (LX9 coil)	–	E7	F7	M7	P7	U7
LC1F265	40...400 Hz (LX1 coil)	B7	E7	F7	M7	P7	U7
LC1F400...F800	40...400 Hz (LX1 coil)	–	E7	F7	M7	P7	U7

For other voltages available between 24 V and 660 V, or a DC control circuit, please contact our Customer Care Center.



NSX100FMA100

+



LC1D80●●

+



ATV950D45N4

IEC standard motor starters

Motor	Drive	Circuit breaker			Line contactor	
Power (1)	Reference	Reference (2)	Rating	I _{rm}	Reference (3) (4) (5)	
kW	HP		A	A		
Three-phase supply voltage: 380...415 V 50/60 Hz						
0.75	1	ATV950U07N4/N4E	GV2L07	2.5	33.5	LC1D09●●
1.5	2	ATV950U15N4/N4E	GV2L08	4	51	LC1D09●●
2.2	3	ATV950U22N4/N4E	GV2L10	6.3	78	LC1D09●●
3	–	ATV950U30N4/N4E	GV2L14	10	138	LC1D09●●
4	5	ATV950U40N4/N4E	GV2L14	10	138	LC1D09●●
5.5	7.5	ATV950U55N4/N4E	GV2L16	14	170	LC1D18●●
7.5	10	ATV950U75N4/N4E	GV2L20	18	223	LC1D18●●
11	15	ATV950D11N4/N4E	GV2L22	25	327	LC1D25●●
15	20	ATV950D15N4/N4E	GV3L32	32	448	LC1D25●●
18.5	25	ATV950D18N4/N4E	GV3L40	40	560	LC1D40A●●
22	30	ATV950D22N4/N4E	GV3L50	50	700	LC1D50A●●
30	40	ATV950D30N4/N4E	GV3L65	65	910	LC1D50A●●
37	50	ATV950D37N4/N4E	NS80HMA	80	1000	LC1D65A●●
45	60	ATV950D45N4/N4E	NSX100●MA100	100	1300	LC1D80●●
55	75	ATV950D55N4/N4E	NSX160●MA150	150	1500	LC1D115●●
75	100	ATV950D75N4/N4E	NSX160●MA150	150	1500	LC1D115●●
90	125	ATV950D90N4/N4E	NSX250●MA220	220	2420	LC1F185●●

(1) Standard power ratings for 400 V 50/60 Hz 4-pole motors.

The values expressed in HP conform to the NEC (National Electrical Code).

(2) For references to be completed, replace the dot with the letter corresponding to the breaking performance of the circuit breaker (F, N, H, S or L).

Breaking capacity of circuit breakers according to standard IEC 60947-2:

Circuit breaker	I _{cu} (kA) for 380...415 V					
	F	N	H	S	L	
GV2L07...L14	100	–	–	–	–	
GV2L16...L22	50	–	–	–	–	
GV3L32...L65	50	–	–	–	–	
NS80HMA	70	–	–	–	–	
NSX100●MA100	–	36	50	70	100	150
NSX160●MA150	–	36	50	70	100	150
NSX250●MA220	–	36	50	70	100	150

(3) Composition of contactors:

LC1D09...D115: 3 poles + 1 NO auxiliary contact + 1 NC auxiliary contact

LC1F185: 3 poles

To add auxiliary contacts or other accessories, please refer to the "Motor-starter solutions - Control and protection components" catalog.

(4) Replace ●● with the control circuit voltage code indicated in the table below:

	Volts ~	24	48	110	220	230	240
LC1D09...D115	50 Hz	B5	E5	F5	M5	P5	U5
	60 Hz	B6	E6	F6	M6	–	U6
	50/60 Hz	B7	E7	F7	M7	P7	U7
LC1F185	50 Hz (LX1 coil)	B5	E5	F5	M5	P5	U5
	60 Hz (LX1 coil)	–	E6	F6	M6	–	U6
	40...400 Hz (LX9 coil)	–	E7	F7	M7	P7	U7

For other voltages available between 24 V and 660 V, or a DC control circuit, please contact our Customer Care Center.

(5) When used with ATV950U07N4/N4E...D90N4/N4E drives, the motor starters must be installed in a separate enclosure to maintain IP 55 protection for the installation.



GV2L08

+



LC1D09●●

+



ATV930U15N4

IEC standard motor starters

Motor Power (1)	Drive Reference	Circuit breaker Reference (2)	Rating	I _{rm}	Line contactor Reference (3) (4)	
kW	HP		A	A		
Three-phase supply voltage: 440 V 50/60 Hz						
0.75	1	ATV930U07N4	GV2L07	2.5	33.5	LC1D09●●
1.5	2	ATV930U15N4	GV2L08	4	51	LC1D09●●
2.2	3	ATV930U22N4	GV2L10	6.3	78	LC1D09●●
3	–	ATV930U30N4	GV2L10	6.3	78	LC1D09●●
4	5	ATV930U40N4	GV2L14	10	138	LC1D09●●
5.5	7.5	ATV930U55N4	GV2L16	14	170	LC1D18●●
7.5	10	ATV930U75N4	GV2L16	14	170	LC1D18●●
11	15	ATV930D11N4	GV2L22	25	327	LC1D25●●
15	20	ATV930D15N4	GV3L32	32	448	LC1D25●●
18.5	25	ATV930D18N4	GV3L40	40	560	LC1D40A●●
22	30	ATV930D22N4	GV3L50	50	700	LC1D50A●●
30	40	ATV930D30N4	GV3L65	65	910	LC1D50A●●
37	50	ATV930D37N4	GV3L65	65	910	LC1D65A●●
45	60	ATV930D45N4	NS80HMA	80	1000	LC1D80●●
55	75	ATV930D55N4C	NSX100●MA100	100	1040	LC1D95●●
75	100	ATV930D75N4C	NSX160●MA150	150	1500	LC1D115●●
90	125	ATV930D90N4C	NSX250●MA220	150	1500	LC1D115●●

(1) Standard power ratings for 400 V 50/60 Hz 4-pole motors.

The values expressed in HP conform to the NEC (National Electrical Code).

(2) For references to be completed, replace the dot with the letter corresponding to the breaking performance of the circuit breaker (F, N, H, S or L).

Breaking capacity of circuit breakers according to standard IEC 60947-2:

Circuit breaker	I _{cu} (kA) for 440 V	Icu (kA) for 440 V				
		F	N	H	S	L
GV2L07...L10	100	–	–	–	–	–
GV2L14...L22	20	–	–	–	–	–
GV3L32...L65	50	–	–	–	–	–
NS80HMA	65	–	–	–	–	–
NSX100●MA100	–	35	50	65	90	130
NSX160●MA150	–	35	50	65	90	130
NSX250●MA220	–	35	50	65	90	130

(3) Composition of contactors:

LC1D09...D115: 3 poles + 1 NO auxiliary contact + 1 NC auxiliary contact

To add auxiliary contacts or other accessories, please refer to the "Motor-starter solutions - Control and protection components" catalog.

(4) Replace ●● with the control circuit voltage code indicated in the table below:

	Volts ~	24	48	110	220	230	240
LC1D09...D115	50 Hz	B5	E5	F5	M5	P5	U5
	60 Hz	B6	E6	F6	M6	–	U6
	50/60 Hz	B7	E7	F7	M7	P7	U7

For other voltages available between 24 V and 660 V, or a DC control circuit, please contact our Customer Care Center.

IEC standard motor starters

Motor		Drive	Circuit breaker			Line contactor
Power (1)		Reference	Reference (2)	Rating	I _{rm}	Reference (3) (4)
kW	HP			A	A	
Three-phase supply voltage: 440 V 50/60 Hz						
110	150	ATV930C11N4C	NSX250●MA220	220	2420	LC1F185●●
132	200	ATV930C13N4C	NSX250●MA220	220	2420	LC1F185●●
160	250	ATV930C16N4C	NSX400● Micrologic 1.3-M	320	3500	LC1F265●●
220	350	ATV930C22N4	NSX630● Micrologic 1.3-M	500	3 000	LC1F400●●
220	350	ATV930C22N4C	NSX630● Micrologic 1.3-M	500	3 000	LC1F400●●
250	400	ATV930C25N4C	NSX630● Micrologic 1.3-M	500	3 000	LC1F500●●
315	500	ATV930C31N4C	NS800L Micrologic 2 or 5	800	1 600	LC1F630●●

(1) Standard power ratings for 400 V 50/60 Hz 4-pole motors.

The values expressed in HP conform to the NEC (National Electrical Code).

(2) For references to be completed, replace the dot with the letter corresponding to the breaking performance of the circuit breaker (F, N, H, S or L).

Breaking capacity of circuit breakers according to standard IEC 60947-2:

Circuit breaker	I _{cu} (kA) for 440 V					
	F	N	H	S	L	
NSX250●MA220	–	35	50	65	90	130
NSX400● Micrologic 1.3-M	–	30	42	65	90	130
NSX630●	–	30	42	65	90	130
NS800L Micrologic 2 or 5	–	–	–	–	–	130

(3) Composition of contactors:

LC1F185...F265: 3 poles To add auxiliary contacts or other accessories, please refer to the "Motor-starter solutions - Control and protection components" catalog.

(4) Replace ●● with the control circuit voltage code indicated in the table below:

	Volts ~	24	48	110	220	230	240
		LC1F185	50 Hz (LX1 coil)	B5	E5	F5	M5
	60 Hz (LX1 coil)	–	E6	F6	M6	–	U6
	40...400 Hz (LX9 coil)	–	E7	F7	M7	P7	U7
LC1F265	40...400 Hz (LX1 coil)	B7	E7	F7	M7	P7	U7
LC1F400...800	40...400 Hz (LX1 coil)	–	E7	F7	M7	P7	U7

For other voltages available between 24 V and 660 V, or a DC control circuit, please contact our Customer Care Center.



NSX250•MA220

+



LC1D115••

+



ATV950D90N4

IEC standard motor starters

Motor Power (1) kW HP	Drive Reference	Circuit breaker			Line contactor
		Reference (2)	Rating A	I _{rm} A	Reference (3) (4) (5)
Three-phase supply voltage: 440 V 50/60 Hz					
0.75 1	ATV950U07N4/N4E	GV2L07	2.5	33.5	LC1D09••
1.5 2	ATV950U15N4/N4E	GV2L08	4	51	LC1D09••
2.2 3	ATV950U22N4/N4E	GV2L10	6.3	78	LC1D09••
3 –	ATV950U30N4/N4E	GV2L10	6.3	78	LC1D09••
4 5	ATV950U40N4/N4E	GV2L14	10	138	LC1D09••
5.5 7.5	ATV950U55N4/N4E	GV2L16	14	170	LC1D18••
7.5 10	ATV950U75N4/N4E	GV2L16	14	170	LC1D18••
11 15	ATV950D11N4/N4E	GV2L22	25	327	LC1D25••
15 20	ATV950D15N4/N4E	GV3L32	32	448	LC1D25••
18.5 25	ATV950D18N4/N4E	GV3L40	40	560	LC1D40A••
22 30	ATV950D22N4/N4E	GV3L50	50	700	LC1D50A••
30 40	ATV950D30N4/N4E	GV3L65	65	910	LC1D50A••
37 50	ATV950D37N4/N4E	GV3L65	65	910	LC1D65A••
45 60	ATV950D45N4/N4E	NS80HMA	80	1000	LC1D80••
55 75	ATV950D55N4/N4E	NSX100•MA100	100	1040	LC1D95••
75 100	ATV950D75N4/N4E	NSX160•MA150	150	1500	LC1D115••
90 125	ATV950D90N4/N4E	NSX250•MA220	150	1500	LC1D115••

(1) Standard power ratings for 400 V 50/60 Hz 4-pole motors.

The values expressed in HP conform to the NEC (National Electrical Code).

(2) For references to be completed, replace the dot with the letter corresponding to the breaking performance of the circuit breaker (F, N, H, S or L).

Breaking capacity of circuit breakers according to standard IEC 60947-2:

Circuit breaker	I _{cu} (kA) for 440 V					
	F	N	H	S	L	
GV2L07...L10	100	–	–	–	–	
GV2L14...L22	20	–	–	–	–	
GV3L32...L65	50	–	–	–	–	
NS80HMA	65	–	–	–	–	
NSX100•MA100	–	35	50	65	90	
NSX160•MA150	–	35	50	65	90	
NSX250•MA220	–	35	50	65	90	

(3) Composition of contactors:

LC1D09...D115: 3 poles + 1 NO auxiliary contact + 1 NC auxiliary contact

To add auxiliary contacts or other accessories, please refer to the "Motor-starter solutions - Control and protection components" catalog.

(4) Replace •• with the control circuit voltage code indicated in the table below:

LC1D09...D115	Volts ~	24	48	110	220	230	240
	50 Hz	B5	E5	F5	M5	P5	U5
60 Hz	B6	E6	F6	M6	–	U6	
50/60 Hz	B7	E7	F7	M7	P7	U7	

For other voltages available between 24 V and 660 V, or a DC control circuit, please contact our Customer Care Center.

(5) When used with ATV950U07N4/N4E...D90N4/N4E drives, the motor starters must be installed in a separate enclosure to maintain IP 55 protection for the installation.

Variable speed drives

Altivar Process ATV900

IP 21 drives: 200...240 V and 380...480 V



200...240 V IP 21/UL Type 1 drives

Overall dimensions

Drives	W x H x D	
	mm	in.
ATV930U07M3	144 x 350 x 206	5.67 x 13.78 x 8.11
ATV930U15M3	144 x 350 x 206	5.67 x 13.78 x 8.11
ATV930U22M3	144 x 350 x 206	5.67 x 13.78 x 8.11
ATV930U30M3	144 x 350 x 206	5.67 x 13.78 x 8.11
ATV930U40M3	144 x 350 x 206	5.67 x 13.78 x 8.11
ATV930U55M3	171 x 409 x 236	6.73 x 16.10 x 9.29
ATV930U75M3	211 x 545.9 x 235	8.31 x 21.49 x 9.25
ATV930D11M3	211 x 545.9 x 235	8.31 x 21.49 x 9.25
ATV930D15M3	226 x 673 x 274	8.90 x 26.50 x 10.79
ATV930D18M3	226 x 673 x 274	8.90 x 26.50 x 10.79
ATV930D22M3	226 x 673 x 274	8.90 x 26.50 x 10.79
ATV930D30M3	290 x 922 x 325.5	11.42 x 36.30 x 12.81
ATV930D37M3	290 x 922 x 325.5	11.42 x 36.30 x 12.81
ATV930D45M3	290 x 922 x 325.5	11.42 x 36.30 x 12.81

200...240 V IP 21/UL Type 1 drives without braking unit

Overall dimensions

Drives	W x H x D	
	mm	in.
ATV930D30M3C	290 x 922 x 325.5	11.42 x 36.30 x 12.81
ATV930D37M3C	290 x 922 x 325.5	11.42 x 36.30 x 12.81
ATV930D45M3C	290 x 922 x 325.5	11.42 x 36.30 x 12.81
ATV930D55M3C	320 x 852 x 393	12.60 x 33.54 x 15.47
With kit for IP 21/UL Type 1 conformity	320 x 1,157 x 393	12.60 x 45.55 x 15.47
ATV930D75M3C	320 x 852 x 393	12.60 x 33.54 x 15.47
With kit for IP 21/UL Type 1 conformity	320 x 1,157 x 393	12.60 x 45.55 x 15.47

380...480 V IP 21/UL Type 1 drives

Overall dimensions

Drives	W x H x D	
	mm	in.
ATV930U07N4	144 x 350 x 206	5.67 x 13.78 x 8.11
ATV930U15N4	144 x 350 x 206	5.67 x 13.78 x 8.11
ATV930U22N4	144 x 350 x 206	5.67 x 13.78 x 8.11
ATV930U30N4	144 x 350 x 206	5.67 x 13.78 x 8.11
ATV930U40N4	144 x 350 x 206	5.67 x 13.78 x 8.11
ATV930U55N4	144 x 350 x 206	5.67 x 13.78 x 8.11
ATV930U75N4	171 x 409 x 236	6.73 x 16.10 x 9.29
ATV930D11N4	171 x 409 x 236	6.73 x 16.10 x 9.29
ATV930D15N4	211 x 545.9 x 235	8.31 x 21.49 x 9.25
ATV930D18N4	211 x 545.9 x 235	8.31 x 21.49 x 9.25
ATV930D22N4	211 x 545.9 x 235	8.31 x 21.49 x 9.25
ATV930D30N4	226 x 673 x 274	8.90 x 26.50 x 10.79
ATV930D37N4	226 x 673 x 274	8.90 x 26.50 x 10.79
ATV930D45N4	226 x 673 x 274	8.90 x 26.50 x 10.79
ATV930D55N4	290 x 922 x 325.5	11.42 x 36.30 x 12.81
ATV930D75N4	290 x 922 x 325.5	11.42 x 36.30 x 12.81
ATV930D90N4	290 x 922 x 325.5	11.42 x 36.30 x 12.81
ATV930C22N4	440 x 1195 x 380	17.32 x 47.04 x 14.96

With kit for IP 21/UL Type 1 conformity (1)

(1) For further information, please contact our Customer Care Center.



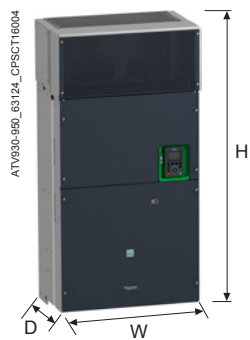

380...480 V IP 21/UL Type 1 drives without braking unit

Overall dimensions

Drives	W x H x D	
	mm	in.
ATV930D55N4C	290 x 922 x 325.5	11.42 x 36.30 x 12.81
ATV930D75N4C	290 x 922 x 325.5	11.42 x 36.30 x 12.81
ATV930D90N4C	290 x 922 x 325.5	11.42 x 36.30 x 12.81
ATV930C11N4C	320 x 852 x 393	12.60 x 33.54 x 15.47
With kit for IP 21/UL Type 1 conformity (1)		
ATV930C13N4C	320 x 852 x 393	12.60 x 33.54 x 15.47
With kit for IP 21/UL Type 1 conformity (1)		
ATV930C16N4C	320 x 852 x 393	12.60 x 33.54 x 15.47
With kit for IP 21/UL Type 1 conformity (1)		
ATV930C22N4C	440 x 1195 x 380	17.32 x 47.04 x 14.96
With kit for IP 21/UL Type 1 conformity (1)		
ATV930C25N4C	598 x 1195 x 380	23.54 x 47.04 x 14.96
With kit for IP 21/UL Type 1 conformity (1)		
ATV930C31N4C	598 x 1195 x 380	23.54 x 47.04 x 14.96
With kit for IP 21/UL Type 1 conformity (1)		

Floor-standing 380...440 V IP 21 drives

Overall dimensions

Drives	W x H x D (2)	
	mm	in.
ATV930C11N4F	400 x 2,150 x 642	15.75 x 84.65 x 25.28
ATV930C13N4F	400 x 2,150 x 642	15.75 x 84.65 x 25.28
ATV930C16N4F	400 x 2,150 x 642	15.75 x 84.65 x 25.28
ATV930C20N4F	600 x 2,150 x 642	23.62 x 84.65 x 25.28
ATV930C25N4F	600 x 2,150 x 642	23.62 x 84.65 x 25.28
ATV930C31N4F	600 x 2,150 x 642	23.62 x 84.65 x 25.28

(1) For further information, please contact our Customer Care Center.
 (2) The total depth includes a door handle of 42 mm/1.65 in.

Variable speed drives

Altivar Process ATV900

IP 55 and IP 54 drives: 380...480 V and 380...440 V

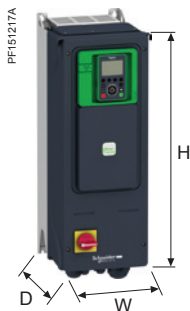

380...480 V IP 55 drives

Overall dimensions

Drives	W x H x D	
	mm	in.
ATV950U07N4	264 x 678 x 272	10.39 x 26.69 x 10.71
ATV950U15N4	264 x 678 x 272	10.39 x 26.69 x 10.71
ATV950U22N4	264 x 678 x 272	10.39 x 26.69 x 10.71
ATV950U30N4	264 x 678 x 272	10.39 x 26.69 x 10.71
ATV950U40N4	264 x 678 x 272	10.39 x 26.69 x 10.71
ATV950U55N4	264 x 678 x 272	10.39 x 26.69 x 10.71
ATV950U75N4	264 x 678 x 299	10.39 x 26.69 x 11.77
ATV950D11N4	264 x 678 x 299	10.39 x 26.69 x 11.77
ATV950D15N4	264 x 678 x 299	10.39 x 26.69 x 11.77
ATV950D18N4	264 x 678 x 299	10.39 x 26.69 x 11.77
ATV950D22N4	264 x 678 x 299	10.39 x 26.69 x 11.77
ATV950D30N4	290 x 910 x 340	11.42 x 35.83 x 13.39
ATV950D37N4	290 x 910 x 340	11.42 x 35.83 x 13.39
ATV950D45N4	290 x 910 x 340	11.42 x 35.83 x 13.39
ATV950D55N4	345 x 1,250 x 375	13.58 x 49.21 x 14.76
ATV950D75N4	345 x 1,250 x 375	13.58 x 49.21 x 14.76
ATV950D90N4	345 x 1,250 x 375	13.58 x 49.21 x 14.76

380...480 V IP 55 drives with Vario disconnect switch

Overall dimensions

Drives	W x H x D (1)	
	mm	in.
ATV950U07N4E	264 x 678 x 300	10.39 x 26.69 x 11.81
ATV950U15N4E	264 x 678 x 300	10.39 x 26.69 x 11.81
ATV950U22N4E	264 x 678 x 300	10.39 x 26.69 x 11.81
ATV950U30N4E	264 x 678 x 300	10.39 x 26.69 x 11.81
ATV950U40N4E	264 x 678 x 300	10.39 x 26.69 x 11.81
ATV950U55N4E	264 x 678 x 330	10.39 x 26.69 x 12.99
ATV950U75N4E	264 x 678 x 330	10.39 x 26.69 x 12.99
ATV950D11N4E	264 x 678 x 330	10.39 x 26.69 x 12.99
ATV950D15N4E	264 x 678 x 330	10.39 x 26.69 x 12.99
ATV950D18N4E	264 x 678 x 330	10.39 x 26.69 x 12.99
ATV950D22N4E	264 x 678 x 330	10.39 x 26.69 x 12.99
ATV950D30N4E	290 x 910 x 401	11.42 x 35.83 x 15.79
ATV950D37N4E	290 x 910 x 401	11.42 x 35.83 x 15.79
ATV950D45N4E	290 x 910 x 401	11.42 x 35.83 x 15.79
ATV950D55N4E	345 x 1,250 x 436	13.58 x 49.21 x 17.17
ATV950D75N4E	345 x 1,250 x 436	13.58 x 49.21 x 17.17
ATV950D90N4E	345 x 1,250 x 436	13.58 x 49.21 x 17.17

Floor-standing 380...440 V IP 54 drives

Overall dimensions

Drives	W x H x D (2)	
	mm	in.
ATV950C11N4F	400 x 2,350 x 664	15.75 x 92.52 x 26.14
ATV950C13N4F	400 x 2,350 x 664	15.75 x 92.52 x 26.14
ATV950C16N4F	400 x 2,350 x 664	15.75 x 92.52 x 26.14
ATV950C20N4F	600 x 2,350 x 664	23.62 x 92.52 x 26.14
ATV950C25N4F	600 x 2,350 x 664	23.62 x 92.52 x 26.14
ATV950C31N4F	600 x 2,350 x 664	23.62 x 92.52 x 26.14

(1) The total depth includes a door handle of 64 mm/2.54 in.

(2) The total depth includes a door handle of 64 mm/2.54 in. The total height includes a plinth of 200 mm/7.87 in.



380...415 V Compact IP 23 Drive Systems

Overall dimensions

Drives	W x H x D (1)	
	mm	in.
ATV960C11Q4X1	400 x 2,150 x 664	15.75 x 84.65 x 26.14
ATV960C13Q4X1	400 x 2,150 x 664	15.75 x 84.65 x 26.14
ATV960C16Q4X1	400 x 2,150 x 664	15.75 x 84.65 x 26.14
ATV960C20Q4X1	600 x 2,150 x 664	23.62 x 84.65 x 26.14
ATV960C25Q4X1	600 x 2,150 x 664	23.62 x 84.65 x 26.14
ATV960C31Q4X1	600 x 2,150 x 664	23.62 x 84.65 x 26.14
ATV960C35Q4X1	800 x 2,150 x 664	31.50 x 84.65 x 26.14
ATV960C40Q4X1	800 x 2,150 x 664	31.50 x 84.65 x 26.14
ATV960C45Q4X1	800 x 2,150 x 664	31.50 x 84.65 x 26.14
ATV960C50Q4X1	800 x 2,150 x 664	31.50 x 84.65 x 26.14
ATV960C56Q4X1	1,200 x 2,150 x 664	47.24 x 84.65 x 26.14
ATV960C63Q4X1	1,200 x 2,150 x 664	47.24 x 84.65 x 26.14
ATV960C71Q4X1	1,400 x 2,150 x 664	55.12 x 84.65 x 26.14
ATV960C80Q4X1	1,400 x 2,150 x 664	55.12 x 84.65 x 26.14

380...415 V Regenerative IP 23 Drive Systems

Overall dimensions

Drives	W x H x D (1)	
	mm	in.
ATV980C11Q4X1	600 x 2,150 x 664	23.62 x 84.65 x 26.14
ATV980C13Q4X1	600 x 2,150 x 664	23.62 x 84.65 x 26.14
ATV980C16Q4X1	600 x 2,150 x 664	23.62 x 84.65 x 26.14
ATV980C20Q4X1	1,000 x 2,150 x 664	39.37 x 84.65 x 23.62
ATV980C25Q4X1	1,000 x 2,150 x 664	39.37 x 84.65 x 26.14
ATV980C31Q4X1	1,000 x 2,150 x 664	39.37 x 84.65 x 26.14
ATV980C35Q4X1	1,600 x 2,150 x 664	62.99 x 84.65 x 26.14
ATV980C40Q4X1	1,600 x 2,150 x 664	62.99 x 84.65 x 26.14
ATV980C45Q4X1	1,600 x 2,150 x 664	62.99 x 84.65 x 26.14
ATV980C50Q4X1	1,600 x 2,150 x 664	62.99 x 84.65 x 26.14
ATV980C56Q4X1	2,000 x 2,150 x 664	78.74 x 84.65 x 26.14
ATV980C63Q4X1	2,000 x 2,150 x 664	78.74 x 84.65 x 26.14
ATV980C71Q4X1	2,600 x 2,150 x 664	102.36 x 84.65 x 26.14
ATV980C80Q4X1	2,600 x 2,150 x 664	102.36 x 84.65 x 26.14

(1) The total depth includes a door handle of 64 mm/2.54 in. The dimensions can differ depending on the chosen options. For further information, please contact our Customer Care Center.

Variable speed drives

Altivar Process ATV900

Braking units and braking resistors

Braking units		
Overall dimensions		
Braking units	W x H x D	
	mm	in.
VW3A7101	103 x 1190 x 380	4.035 x 46.85 x 14.96
VW3A7102	310 x 1150 x 380	12.20 x 45.27 x 14.96
VW3A7105	216 x 658 x 303	8.50 x 25.91 x 11.93
VW3A7106	216 x 658 x 303	8.50 x 25.91 x 11.93

Braking resistors		
Overall dimensions		
Braking resistors	W x H x D	
	mm	in.
VW3A7730	105 x 295 x 100	4.13 x 11.61 x 3.94
VW3A7731	105 x 345 x 100	4.13 x 13.58 x 3.94
VW3A7732	175 x 345 x 100	6.89 x 13.58 x 3.94
VW3A7733	190 x 570 x 180	7.48 x 22.44 x 7.09
VW3A7734	250 x 490 x 180	9.84 x 19.29 x 7.09
VW3A7735	250 x 490 x 180	9.84 x 19.29 x 7.09
VW3A7736	485 x 410 x 485	19.09 x 16.14 x 19.09
VW3A7737	485 x 410 x 485	19.09 x 16.14 x 19.09
VW3A7738	485 x 410 x 445	19.09 x 16.14 x 17.52
VW3A7740	105 x 465 x 100	4.13 x 18.31 x 3.94
VW3A7741	175 x 465 x 100	6.89 x 18.31 x 3.94
VW3A7742	190 x 570 x 180	7.48 x 22.44 x 7.09
VW3A7743	290 x 570 x 180	11.42 x 22.44 x 7.09
VW3A7744	450 x 490 x 180	17.72 x 19.29 x 7.09
VW3A7745	485 x 610 x 485	19.09 x 24.02 x 19.09
VW3A7746	485 x 610 x 485	19.09 x 24.02 x 19.09
VW3A7747	485 x 1020 x 485	19.09 x 40.16 x 19.09
VW3A7748	485 x 610 x 485	19.09 x 24.02 x 19.09
VW3A7750	290 x 570 x 180	11.42 x 22.44 x 7.09
VW3A7751	390 x 570 x 180	15.35 x 22.44 x 7.09
VW3A7752	485 x 610 x 485	19.09 x 24.02 x 19.09
VW3A7753	485 x 1,020 x 605	19.09 x 40.16 x 23.82
VW3A7754	485 x 820 x 1,035	19.09 x 32.28 x 40.75
VW3A7755	485 x 1,020 x 1,035	19.09 x 40.16 x 40.75
VW3A7756	485 x 1,020 x 1,285	19.09 x 40.16 x 50.59
VW3A7757	485 x 1,020 x 1,285	19.09 x 40.16 x 50.59

Passive filters: 400 V 50 Hz three-phase supply		
Overall dimensions		
Passive filters	W x H x D	
	mm	in.
VW3A46101	190 x 332.11 x 205.5	7.48 x 13.08 x 8.09
VW3A46102	190 x 332.11 x 205.5	7.48 x 13.08 x 8.09
VW3A46103	190 x 332.11 x 205.5	7.48 x 13.08 x 8.09
VW3A46104	232 x 436.11 x 247.5	9.13 x 17.17 x 9.74
VW3A46105	232 x 436.11 x 247.5	9.13 x 17.17 x 9.74
VW3A46106	378 x 594.08 x 242	14.88 x 23.39 x 9.53
VW3A46107	378 x 594.08 x 242	14.88 x 23.39 x 9.53
VW3A46108	378 x 623.6 x 333	14.88 x 24.55 x 13.11
VW3A46109	378 x 623.6 x 333	14.88 x 24.55 x 13.11
VW3A46110	418 x 736.8 x 333	16.46 x 29.01 x 13.11
VW3A46111	418 x 736.8 x 333	16.46 x 29.01 x 13.11
VW3A46112	418 x 767.6 x 400	16.46 x 30.22 x 15.75
VW3A46113	418 x 767.6 x 400	16.46 x 30.22 x 15.75
VW3A46114	468 x 900.06 x 448.5	18.42 x 35.43 x 17.66
VW3A46115	468 x 900.06 x 448.5	18.42 x 35.43 x 17.66
VW3A46116	468 x 900.06 x 448.5	18.42 x 35.43 x 17.66
VW3A46118	420 x 800 x 448.5	16.54 x 31.50 x 17.66
VW3A46119	420 x 800 x 510	16.54 x 31.50 x 20.00
VW3A46120	190 x 332.11 x 205.5	7.48 x 13.08 x 8.09
VW3A46121	190 x 332.11 x 205.5	7.48 x 13.08 x 8.09
VW3A46122	190 x 332.11 x 205.5	7.48 x 13.08 x 8.09
VW3A46123	232 x 436.11 x 247.5	9.13 x 17.17 x 9.74
VW3A46124	232 x 436.11 x 247.5	9.13 x 17.17 x 9.74
VW3A46125	378 x 594.08 x 242	14.88 x 23.39 x 9.53
VW3A46126	378 x 594.08 x 242	14.88 x 23.39 x 9.53
VW3A46127	378 x 623.6 x 333	14.88 x 24.55 x 13.11
VW3A46128	378 x 623.6 x 333	14.88 x 24.55 x 13.11
VW3A46129	418 x 736.8 x 333	16.46 x 29.01 x 13.11
VW3A46130	418 x 736.8 x 333	16.46 x 29.01 x 13.11
VW3A46131	418 x 767.6 x 400	16.46 x 30.22 x 15.75
VW3A46132	418 x 767.6 x 400	16.46 x 30.22 x 15.75
VW3A46133	468 x 900.06 x 448.5	18.42 x 35.43 x 17.66
VW3A46134	468 x 900.06 x 448.5	18.42 x 35.43 x 17.66
VW3A46135	468 x 900.06 x 510	18.42 x 35.43 x 20
VW3A46137	420 x 800 x 510	16.54 x 31.50 x 20.00
VW3A46138	420 x 800 x 510	16.54 x 31.50 x 20.00

Variable speed drives

Altivar Process ATV900

Passive filters

Passive filters: 460 V 60 Hz three-phase supply		
Overall dimensions		
Passive filters	W x H x D	
	mm	in.
VW3A46139	190 x 332.11 x 205.5	7.48 x 13.08 x 8.09
VW3A46140	190 x 332.11 x 205.5	7.48 x 13.08 x 8.09
VW3A46141	190 x 332.11 x 205.5	7.48 x 13.08 x 8.09
VW3A46142	232 x 436.11 x 247.5	9.13 x 17.17 x 9.74
VW3A46143	232 x 436.11 x 247.5	9.13 x 17.17 x 9.74
VW3A46144	378 x 594.08 x 242	14.88 x 23.39 x 9.53
VW3A46145	378 x 594.08 x 242	14.88 x 23.39 x 9.53
VW3A46146	378 x 594.08 x 242	14.88 x 23.39 x 9.53
VW3A46147	378 x 623.6 x 333	14.88 x 24.55 x 13.11
VW3A46148	378 x 623.6 x 333	14.88 x 24.55 x 13.11
VW3A46149	418 x 736.8 x 333	16.46 x 29.01 x 13.11
VW3A46150	418 x 736.8 x 333	16.46 x 29.01 x 13.11
VW3A46151	418 x 767.6 x 400	16.46 x 30.22 x 15.75
VW3A46152	418 x 767.6 x 400	16.46 x 30.22 x 15.75
VW3A46153	468 x 900.06 x 448.5	18.42 x 35.43 x 17.66
VW3A46154	468 x 900.06 x 448.5	18.42 x 35.43 x 17.66
VW3A46155	420 x 800 x 448.5	16.54 x 31.50 x 17.66
VW3A46157	420 x 800 x 510	16.54 x 31.50 x 20.00
VW3A46158	190 x 332.11 x 205.5	7.48 x 13.08 x 8.09
VW3A46159	190 x 332.11 x 205.5	7.48 x 13.08 x 8.09
VW3A46160	190 x 332.11 x 205.5	7.48 x 13.08 x 8.09
VW3A46161	232 x 436.11 x 247.5	9.13 x 17.17 x 9.74
VW3A46162	232 x 436.11 x 247.5	9.13 x 17.17 x 9.74
VW3A46163	378 x 594.08 x 242	14.88 x 23.39 x 9.53
VW3A46164	378 x 594.08 x 242	14.88 x 23.39 x 9.53
VW3A46165	378 x 594.08 x 242	14.88 x 23.39 x 9.53
VW3A46166	378 x 623.6 x 333	14.88 x 24.55 x 13.11
VW3A46167	378 x 623.6 x 333	14.88 x 24.55 x 13.11
VW3A46168	418 x 736.8 x 333	16.46 x 29.01 x 13.11
VW3A46169	418 x 736.8 x 333	16.46 x 29.01 x 13.11
VW3A46170	418 x 767.6 x 400	16.46 x 30.22 x 15.75
VW3A46171	418 x 767.6 x 400	16.46 x 30.22 x 15.75
VW3A46172	468 x 900.06 x 448.5	18.42 x 35.43 x 17.66
VW3A46173	468 x 900.06 x 510	18.42 x 35.43 x 20.00
VW3A46174	420 x 800 x 510	16.54 x 31.50 x 20.00
VW3A46176	420 x 800 x 510	16.54 x 31.50 x 20.00

Variable speed drives

Altivar Process ATV900

EMC, dv/dt, sinus and common mode filters

Additional EMC input filters

Overall dimensions

EMC filters	W x H x D	
	mm	in.
VW3A4411	800 x 261 x 139	31.49 x 10.27 x 5.47
VW3A4701	75 x 220 x 130	2.95 x 8.66 x 5.12
VW3A4702	75 x 240 x 140	2.95 x 9.45 x 5.51
VW3A4703	80 x 302 x 155	3.15 x 11.89 x 6.10
VW3A4704	90 x 283 x 165	3.54 x 11.14 x 6.50
VW3A4705	100 x 328 x 175	3.94 x 12.91 x 6.89
VW3A4706	120 x 340 x 180	4.72 x 13.39 x 7.09
VW3A4707	130 x 395 x 240	5.12 x 15.55 x 9.45
VW3A4708	200 x 455 x 320	7.87 x 17.91 x 12.60
VW3A4709	260 x 520 x 117	10.24 x 20.47 x 4.61
VW3A4710	260 x 520 x 117	10.24 x 20.47 x 4.61

dv/dt filters

Overall dimensions

dv/dt filters	W x H x D	
	mm	in.
VW3A5106	245 x 250 x 139	9.65 x 9.84 x 7.87
VW3A5107	320 x 250 x 220	12.60 x 9.84 x 8.66
VW3A5301	285 x 530 x 215	10.79 x 20.33 x 8.17
VW3A5302	285 x 530 x 215	10.79 x 20.33 x 8.17
VW3A5303	285 x 530 x 215	10.79 x 20.33 x 8.17
VW3A5304	300 x 560 x 245	11.44 x 21.32 x 9.35
VW3A5305	300 x 610 x 245	11.44 x 23.09 x 9.35
VW3A5306	380 x 325 x 235	14.57 x 8.82 x 12.43
VW3A5307	420 x 350 x 270	15.75 x 9.72 x 13.41

Sinus filters

Overall dimensions

Sinus filters	W x H x D	
	mm	in.
VW3A5209	480 x 340 x 600	18.9 x 13.38 x 23.62
VW3A5210	480 x 370 x 710	18.9 x 14.57 x 27.95
VW3A5401	210 x 455 x 210	8.03 x 17.32 x 7.91
VW3A5402	210 x 455 x 210	8.03 x 17.32 x 7.91
VW3A5403	280 x 530 x 215	10.79 x 20.33 x 8.17
VW3A5404	300 x 560 x 245	11.46 x 21.32 x 9.35
VW3A5405	375 x 760 x 280	14.59 x 29.00 x 10.75
VW3A5406	430 x 325 x 495	16.54 x 12.56 x 18.92
VW3A5407	460 x 370 x 565	17.72 x 14.19 x 21.59

Common mode filters

Overall dimensions

Common mode filters	W x H x D	
	mm	in.
VW3A5501	66 x 119.2 x 66	2.60 x 4.69 x 2.60
VW3A5502	66 x 163.8 x 66	2.60 x 6.45 x 2.60
VW3A5503	127.5 x 161 x 127.5	5.02 x 6.34 x 5.02
VW3A5504	127.5 x 210 x 127.5	5.02 x 8.27 x 5.02
VW3A5505	191 x 197 x 196	7.52 x 7.76 x 7.72
VW3A5506	191 x 256 x 196	7.52 x 10.08 x 7.72

Variable speed drives

Altivar Process

A whole world of services for your drives by Schneider Electric



Presentation

Schneider Electric offers an extensive range of support services to help ensure the reliability of your installation in the long term, control your maintenance costs, and keep your process running at peak performance for maximum efficiency. Altivar Process has been designed in harmony with a whole range of services offered by Schneider Electric.

A worldwide network, 24/7: <ul style="list-style-type: none"> 400 highly qualified and certified experts Field service engineers, online experts 		A digital world of services: <ul style="list-style-type: none"> Schneider Electric Customer Care app Remote technical support 	
People			Digitized support material
Spare parts			Service provisions
A dedicated supply chain: <ul style="list-style-type: none"> All the spare parts you need Designed and manufactured by Schneider Electric 		An optimal life cycle model: <ul style="list-style-type: none"> Spare parts management, exchange and repairs Extended warranties, maintenance plans 	

Schneider Electric drive maintenance expert certification

- A worldwide network, 24/7:
- 400 highly qualified and certified experts
 - Our field service engineers follow a proven drives certification program designed to support you with maximum expertise and efficiency.
 - They use a range of professional tools and software to provide fast, in-depth diagnostics and repairs.

	Repair centers	Low voltage (LV) drives field service engineers	Medium voltage (MV) drives field service engineers
Module A	LV drive safety training		MV drive safety training
Module B	Technical training for LV drives		Technical training for MV drives
Module C	Repair center audit	Skills assessment	On-site start-up
Module D	Certification procedure		
Module E	Registration in Schneider Electric's international directory of Drives skills		
Module F	Re-certification every 2 years		

Variable speed drives

Altivar Process

A whole world of services for your drives by Schneider Electric

Drives support and services offer by Schneider Electric

Schneider Electric has developed a generic services offer to assist you throughout the life cycle of your product. From the planning stage right through to renewal, whether for standard or critical operations, you will find the solution you need in our set of standardized offers.

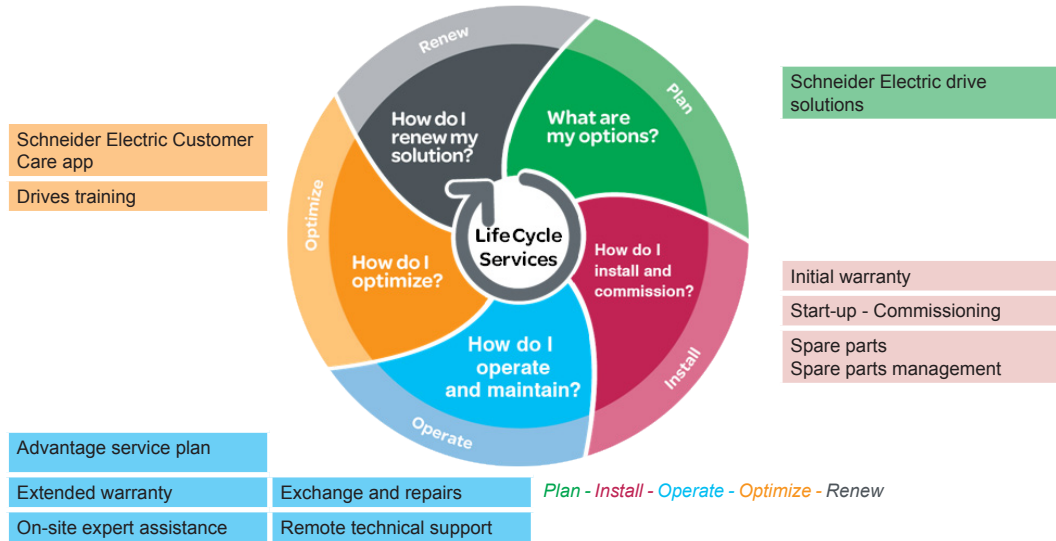

The offer	Contact, How to order	Description
Schneider Electric drive solutions	Contact your local Customer Care Center	Our Schneider Electric experts can help you design your installation, offering whatever type of assistance you need from technical support to turnkey solutions.
Start-up - Commissioning	Contact your local Customer Care Center	Our team of experts are specialists in installation commissioning and start-up whatever the conditions and for any application. This will extend your warranty period by an extra 6 months.
Spare parts - Spare parts management	Contact your local Customer Care Center	Our spare parts are available for the lifetime of your equipment. They are designed and manufactured to the same high quality standards as our products. They are available via a dedicated supply chain for emergency shipments. Our team can help you identify critical parts and define the right level of stock required. Whether stored in your premises (on-site) or in a central store (off-site), it is reassuring to know that critical spare parts are available 24/7.
Exchange and repairs	Contact your local Customer Care Center	Schneider Electric offers high-quality repair services via a global network of certified repair centers and certified field service engineers to cover any need: repairs in Schneider Electric repair centers, exchanges with refurbished products, or on-site repairs (Schneider Electric intervention on your premises).
Remote technical support	Contact your local Customer Care Center	Direct priority access to our experts to help you solve any technical difficulties. Our experts have extensive field experience and have fully mastered the technologies implemented. A simple phone conversation or on-line chat is usually sufficient to help you find the optimal solution and can help keep your costs down by avoiding on-site intervention.
On-site technical support	Contact your local Customer Care Center	Our field service engineers can support your maintenance staff in their everyday operations, or engage when requested in the event of an emergency.
Extended warranty	Contact your local Customer Care Center	Spare parts and repairs performed by Schneider Electric experts on duty.
Advantage service plan	Contact your local Customer Care Center	The Advantage Service plan combines the Preventive Maintenance program (annual visit for inspection, checks, and replacement of worn parts) with the extended warranty (covering spare parts and repairs), plus remote technical support.
Drives training	Contact your local Customer Care Center	A comprehensive suite of training courses to master your Altivar Process drive at any stage in the life cycle of your installation.
mySchneider Customer Care app	Download from the Apple Store® or Google Play Store™	Free download from the Apple Store® or Google Play Store™. Immediate access to Schneider Electric Customer Care Centers, product documentation, FAQs, Cloud services, etc. and plenty of other services yet to come.

4			T		
490NTC00005	38	ATV930U40M3	18	VW3A5301	54
490NTC00005U	38	ATV930U40N4	19		55
490NTC00015	38	ATV930U55M3	18	VW3A5302	54
490NTC00015U	38	ATV930U55N4	19		55
490NTW00002	38	ATV930U75M3	18	VW3A5303	54
490NTW00002U	38	ATV930U75N4	19		55
490NTW00005	38	ATV950C11N4F	14	VW3A5304	54
490NTW00005U	38		23		55
490NTW00012	38	ATV950C13N4F	23	VW3A5305	54
490NTW00012U	38	ATV950C16N4F	23		55
		ATV950C20N4F	23	VW3A5306	54
		ATV950C25N4F	23		55
		ATV950C25N4F	23	VW3A5307	54
		ATV950C31N4F	23		55
		ATV950D11N4	21	VW3A5401	56
		ATV950D11N4E	22		57
		ATV950D11N4F	20	VW3A5402	56
		ATV950D15N4	21		57
		ATV950D15N4E	22	VW3A5403	56
		ATV950D18N4	21		57
		ATV950D18N4E	22	VW3A5404	56
		ATV950D22N4	21		57
		ATV950D22N4E	22	VW3A5405	56
		ATV950D30N4	21		57
		ATV950D30N4E	22	VW3A5406	56
		ATV950D37N4	21		57
		ATV950D37N4E	22	VW3A5407	56
		ATV950D45N4	21		57
		ATV950D45N4E	22	VW3A7101	42
		ATV950D55N4	21	VW3A7102	42
		ATV950D55N4E	22	VW3A7105	42
		ATV950D75N4	21	VW3A7106	42
		ATV950D90N4	21	VW3A7730	43
		ATV950D90N4E	22		44
		ATV950U07N4	14	VW3A7731	43
			21		44
		ATV950U07N4E	14	VW3A7732	43
			22		44
		ATV950U15N4	21	VW3A7733	43
		ATV950U15N4E	22		44
		ATV950U22N4	21	VW3A7734	43
		ATV950U22N4E	22		44
		ATV950U30N4	21	VW3A7735	43
		ATV950U30N4E	22		44
		ATV950U40N4	21	VW3A7736	43
		ATV950U40N4E	22		44
		ATV950U55N4	21	VW3A7737	43
		ATV950U55N4E	22		44
		ATV950U75N4	21	VW3A7738	43
		ATV950U75N4E	22		44
				VW3A7740	44
					45
				VW3A7741	44
					45
				VW3A7742	44
					45
				VW3A7743	44
					45
				VW3A7744	44
					45
				VW3A7745	44
					44
				VW3A7746	44
					45
				VW3A7747	44
					45
				VW3A7748	43
					44
				VW3A7750	45
					45
				VW3A7751	45
					45
				VW3A7752	45
					45
				VW3A7753	45
					45
				VW3A7754	45
					45
				VW3A7755	45
					45
				VW3A7756	44
					45
				VW3A7757	27
					38
				VW3A8306R03	27
					38
				VW3A8306R10	27
					38
				VW3A8306R30	27
					38
				VW3A8306RC	27
					38
				VW3A8306TF03	27
					38
				VW3A8306TF10	27
					38
				VW3A9112	25
					25
				VW3A9113	25
					25
				VW3A9114	25
					25
				VW3A9212	25
					25
				VW3A9213	25
					25
				VW3A9214	25
					25
				VW3A9704	46
					46
				VW3A46101	46
					46
				VW3A46102	46
					46
				VW3A46103	46
					46
				VW3A46104	46
					46
				VW3A46105	46
					46
				VW3A46106	46
					46
				VW3A46107	46
					46
				VW3A46108	46
					46
				VW3A46109	46
					46
				VW3A46110	46
					46
				VW3A46111	46
					46
				VW3A46112	46
					46
				VW3A46113	46
					47
				VW3A46114	47
					47
				VW3A46115	47
					47
				VW3A46116	47
					47
				VW3A46118	47
					47
				VW3A46119	47
					48
				VW3A46120	48
					48
				VW3A46121	48
					48
				VW3A46122	48
					48
				VW3A46123	48
					48
				VW3A46124	48
					48
				VW3A46125	48
					48
				VW3A46126	48
					48
				VW3A46127	48
					48
				VW3A46128	48
					48
				VW3A46129	48
					48
				VW3A46130	48
					48
				VW3A46131	48
					48
				VW3A46132	48
					49
				VW3A46133	49
					49
				VW3A46134	49
					49
				VW3A46135	49
					49
				VW3A46137	49
					49
				VW3A46138	50
					50
				VW3A46139	50
					50
				VW3A46140	50
					50
				VW3A46141	50
					50
				VW3A46142	50
					50
				VW3A46143	50
					50
				VW3A46144	50
					50

VW3A46145	50
VW3A46146	50
VW3A46147	50
VW3A46148	50
VW3A46149	50
VW3A46150	50
VW3A46151	50
VW3A46152	50
VW3A46153	50
VW3A46154	50
VW3A46155	50
VW3A46157	50
VW3A46158	51
VW3A46159	51
VW3A46160	51
VW3A46161	51
VW3A46162	51
VW3A46163	51
VW3A46164	51
VW3A46165	51
VW3A46166	51
VW3A46167	51
VW3A46168	51
VW3A46169	51
VW3A46170	51
VW3A46171	51
VW3A46172	51
VW3A46173	51
VW3A46174	51
VW3A46176	51
VW3A47901	53
VW3A47902	53
VW3A47903	53
VW3A47904	53
VW3A47905	53
VW3A47906	53
VW3A47907	53
VW3A47908	53
VW3A53901	57
VW3A53902	55 57
VW3A53903	55 57
VW3A53904	57
VW3A53905	55
VW3CANCARR1	39
VW3CANCARR03	39
VW3CANTAP2	40
VW3M4701	34
VW3M8221R1000	34
VX5VP50A001	24
VX5VP50BC001	24
VX5VPM001	24
VX5VPM002	24
VX5VPS1001	24
VX5VPS2001	24
VX5VPS3001	24
VX5VPS4001	24
VX5VPS5001	24
VX5VPS6001	24

Z

ZB5AZ905	27
----------	----