

Inputs / Entrées / Eingänge / Entradas / Ingressi

I1 ... I6 0/1

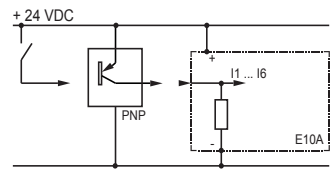

PNP

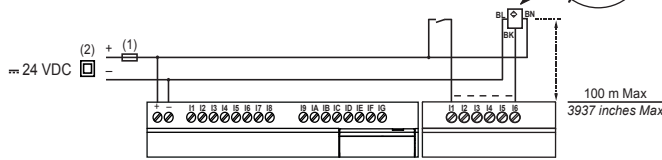

I1 ... I6 U / I

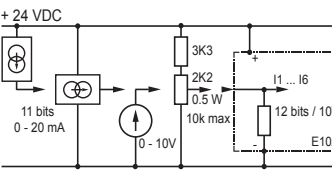

20 mA, 10 V, R

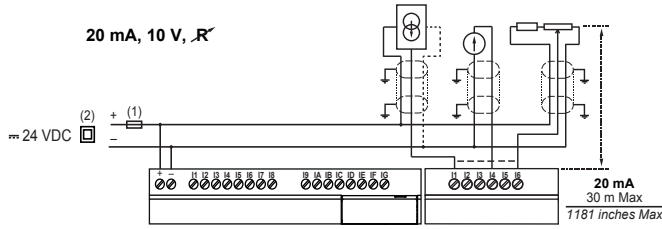

(1) 1 A (UL248) quick-blowing fuse, circuit-breaker or circuit protector (US) / Fusible ultra rapide 1 A (UL248) ou coupe circuit / Ultraschnellsicherung 1 A (UL248) oder Geräteschutzsicherung / Fusible ultra rápido 1 A (UL248) o interruptor de circuito / Fusibile ultra rapido 1 A (UL248) o interruttore.

(2) Isolating source / Double isolation / doppelte Isolierung / doble aislamiento / doppio isolamento

10 V, R
10 m Max
393.7 inches Max

Outputs / Sorties / Ausgänge / Salidas / Uscite

O1 & O2

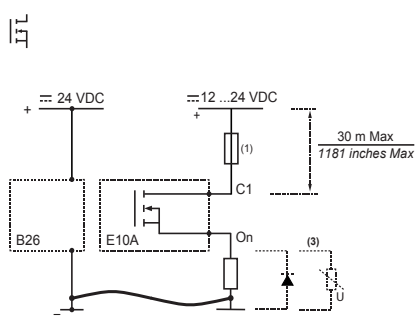

Protection / Protection / Schutzschaltung / Protección / Protezione

(1) 1 A (UL248) quick-blowing fuse, circuit-breaker or circuit protector (US) / Fusible ultra rapide 1 A (UL248) ou coupe circuit / Ultraschnellsicherung 1 A (UL248) der Geräteschutzsicherung / Fusible ultra rápido 1 A (UL248) o interruptor de circuito / Fusibile ultra rapido 1 A (UL248) o interruttore.

(2) Isolating source / Double isolation / doppelte Isolierung / doble aislamiento / doppio isolamento

(3) Inductive load / Charge inductive / Induktive Last / Carga inductiva / Carico induttivo

O3 & O4

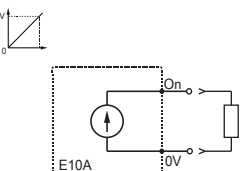

0-10 V, R

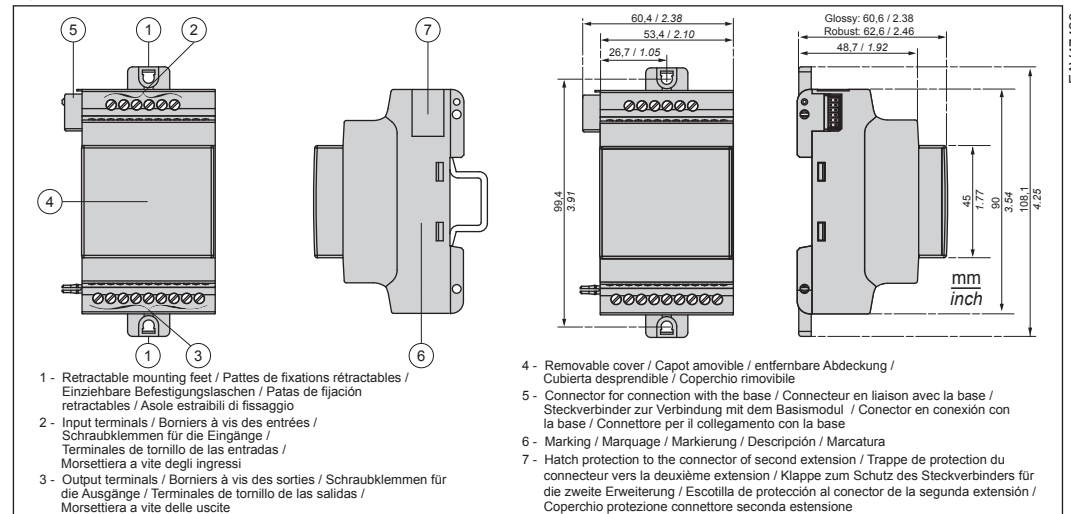
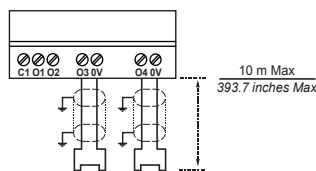

- 1 - Retractable mounting feet / Pattes de fixations rétractables / Einziehbare Befestigungslaschen / Patas de fijación retractables / Asole estraibili di fissaggio
- 2 - Input terminals / Borniers à vis des entrées / Schraubklemmen für die Eingänge / Terminales de tornillo de las entradas / Morsetteria a vite degli ingressi
- 3 - Output terminals / Borniers à vis des sorties / Schraubklemmen für die Ausgänge / Terminales de tornillo de las salidas / Morsetteria a vite delle uscite
- 4 - Removable cover / Capot amovible / entfernbare Abdeckung / Cubierta desprendible / Coperchio rimovibile
- 5 - Connector for connection with the base / Connecteur en liaison avec la base / Steckverbinder zur Verbindung mit dem Basismodul / Conector en conexión con la base / Connettore per il collegamento con la base
- 6 - Marking / Marquage / Markierung / Descripción / Marcatura
- 7 - Hatch protection to the connector of second extension / Trappe de protection du connecteur vers la deuxième extension / Klappe zum Schutz des Steckverbinders für die zweite Erweiterung / Escollita de protección al conector de la segunda extensión / Coperchio protezione connettore seconda estensione

IMPORTANT : This document provides installation instructions only. See the workshop's help for the programming workshop and operation. Those responsible for the application, implementation or use of this product must ensure that the necessary design considerations have been incorporated into each application, completely adhering to applicable laws, performance and safety requirements, regulations, codes and standards. The customer is responsible for all consequences of the application.

IMPORTANT : Ce document ne fournit que des instructions d'installation. Reportez-vous à l'aide de l'atelier pour le fonctionnement et l'utilisation de l'atelier de programmation. Les responsables de l'application, de la mise en œuvre ou de l'utilisation de ce produit doivent s'assurer que les considérations nécessaires de conception ont été incorporées à chaque application, en parfaite adéquation aux lois, aux besoins de performance et de sécurité, à la réglementation, aux normes et standards. Le client est responsable des conséquences de son application.

IMPORTANTE : Este documento proporciona instrucciones para la instalación únicamente. Consulte la ayuda del taller para la operación y el uso de la programación. Los responsables de la aplicación, implementación o uso de este producto deben asegurarse que las consideraciones de diseño necesarias hayan sido incorporadas en cada aplicación, completamente de acuerdo con las leyes, requerimientos de rendimiento y seguridad, regulaciones, códigos y modelos aplicables. El cliente es responsable de la consecuencia de su aplicación.

▲ DANGER	▲ DANGER	▲ PELIGRO
<p>HAZARD OF ELECTRIC SHOCK, EXPLOSION OR ARC FLASH</p> <p>- Turn power off before installing, removing, wiring or maintaining.</p> <p>Failure to follow this instruction will result in death or serious injury.</p>	<p>RISQUE D'ELECTROCUTION, D'EXPLOSION OU D'ARC ELECTRIQUE</p> <p>- Coupez l'alimentation avant d'installer, de câbler ou d'effectuer une opération de maintenance.</p> <p>Le non-respect de cette instruction entraînera la mort ou des blessures graves.</p>	<p>RIESGO DE ELECTROCUCION, DE EXPLOSION O ARCO ELECTRICO</p> <p>- Desconecte la alimentación antes de realizar los procesos de instalación, cableado, o mantenimiento.</p> <p>Si no se respetan estas instrucciones, se producirán graves daños corporales o la muerte.</p>
▲ WARNING	▲ AVERTISSEMENT	▲ ADVERTENCIA
<p>EXPLOSION HAZARD</p> <p>- Confirm that the product power supply voltage and its tolerances are compatible with those of the network.</p> <p>- Do not disconnect equipment unless power has been switched off or the area is known to be non-hazardous.</p> <p>UNINTENDED EQUIPMENT OPERATION</p> <p>- This product is not intended for use in safety critical machine functions. Where personnel and or equipment hazard exist, use appropriate hard-wired safety interlocks.</p> <p>- Do not disassemble, repair or modify the controllers.</p> <p>- This controller is designed for use within an enclosure according to specifications described in these instructions in the paragraph on installation conditions.</p> <p>- Install the controllers in the operating environment conditions described below.</p> <p>Failure to follow these instructions can result in death, serious injury or equipment damage.</p>	<p>RISQUE D'EXPLOSION</p> <p>- Assurez-vous que la tension d'alimentation du produit, avec ses tolérances, est compatible avec celles du réseau.</p> <p>- Assurez-vous que l'alimentation est coupée ou que la zone ne présente aucun danger avant de connecter l'équipement.</p> <p>OPERATION D'EQUIPEMENT NON INTENTIONNELLE</p> <p>- Ce produit ne doit pas être utilisé dans des fonctions critiques de machine de sûreté. Là où il existe des risques pour le personnel et/ou le matériel, utilisez les contacts de sécurité câblés appropriés.</p> <p>- Ne démontez pas, réparez, ni modifiez le contrôleur.</p> <p>- Ce contrôleur logique doit être utilisé dans une enceinte fermée, selon les spécifications décrites dans cette notice, au paragraphe Conditions d'installation.</p> <p>- Installez les contrôleurs dans un environnement de fonctionnement normal, comme indiqué.</p> <p>Le non-respect de ces instructions peut entraîner la mort, des lésions corporelles graves ou des dommages matériels.</p>	<p>RIESGO DE EXPLOSION</p> <p>- Asegúrese de que la tensión de alimentación del producto y sus tolerancias son compatibles con las de la red eléctrica.</p> <p>- No conecte el equipo a menos que se haya eliminado la alimentación o que la zona no sea peligrosa.</p> <p>OPERACION DEL EQUIPO INVOLUNTARIA</p> <p>- Este producto no está diseñado para un uso en funciones críticas de una máquina de seguridad. Donde existan riesgos para el personal o el equipamiento, use cierres de seguridad cableados adaptados.</p> <p>- No desmonte, repare ni modifique los productos.</p> <p>- Este producto está diseñado para un uso en recinto cerrado, según las especificaciones que se describen en estas instrucciones, en el párrafo de Condiciones de Instalación.</p> <p>- Instale los productos en las condiciones de entorno de funcionamiento descritas.</p> <p>Si no se respetan estas precauciones pueden producirse graves lesiones, daños materiales o incluso la muerte.</p>

This device complies with part 15 of the FCC Rules. Operation is subject to the following two conditions:
 (1) This device may not cause harmful interference, and (2) This device must accept any interference received, including interference that may cause undesired operation.
 This equipment has been tested and found to comply with the limits for a Class B digital device, pursuant to part 15 of the FCC Rules. These limits are designed to provide reasonable protection against harmful interference in a residential installation. This equipment generates, uses and can radiate radio frequency energy and, if not installed and used in accordance with the instructions, may cause harmful interference to radio communications. However, there is no guarantee that interference will not occur in a particular installation. If this equipment does cause harmful interference to radio or television reception, which can be determined by turning the equipment off and on, the user is encouraged to try to correct the interference by one or more of the following measures:

- Reorient or relocate the receiving antenna.
- Increase the separation between the equipment and receiver.
- Connect the equipment into an outlet on a circuit different from that to which the receiver is connected.
- Consult the dealer or an experienced radio/TV technician for help

Electrical equipment should be installed, operated, serviced and maintained only by qualified personnel. No responsibility is assumed by Crouzet Automatismes for any consequences arising out of use of this manual. Les équipements électriques doivent être installés, exploités et entretenus par un personnel qualifié. Crouzet Automatismes n'assume aucune responsabilité des conséquences éventuelles découlant de l'utilisation de cette documentation. Sólo el personal de servicio cualificado podrá instalar, utilizar y mantener el equipo eléctrico.

Download em4 soft : www.crouzet-automation.com/em4-soft

Update em4

Download installation sheet, datasheet... : www.crouzet-automation.com/support/techdatabase

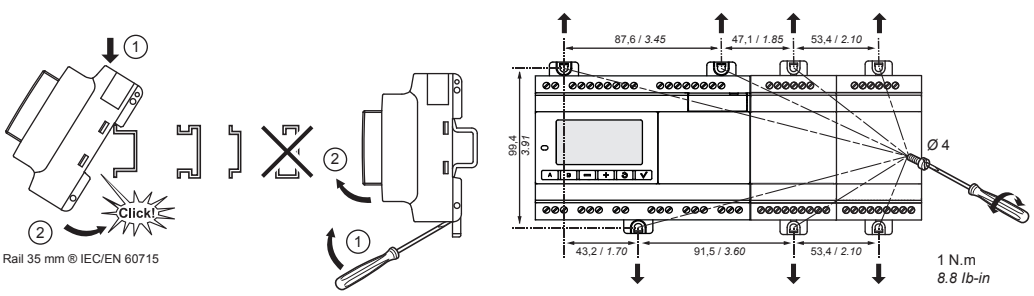

mm				
inch				
mm ²	0.2...2.5	0.2...0.75	0.2...2.5	0.2...0.75
AWG	24...14	24...18	24...14	24...18
UL: Cu, 75°C min				
	C			
Ø 3.5 (0.14 in)	C		N.m	0.5
			lb-in	4.5

Product customization / Personnalisation du produit / Produkt anpassen / Personalización del producto / Personalizzazione del prodotto

Only Glossy version / Version Glossy uniquement / Glossy-Version / Solamente versión Glossy (brillante) / Solo versione Glossy

Enclosure Type 1 mounting instruction / Instruction de montage type de chassis 1 / Gehäuseschutzart 1 Montageanleitung / Instrucción de montaje de tipo de chasis 1 / Istruzioni di montaggio a pannello (type 1 enclosure)

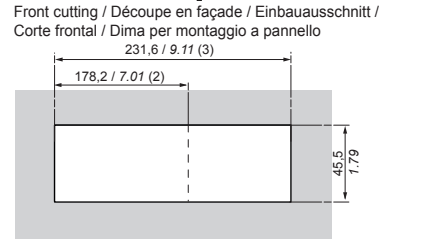
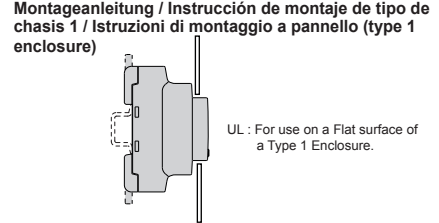

- 2 - With one extension / Avec une extension / Mit einer Erweiterung / Con una extensión / Con una estension
- 3 - With two extensions / Avec deux extensions / Mit zwei Erweiterungen / Con dos extensiones / Con due estensioni

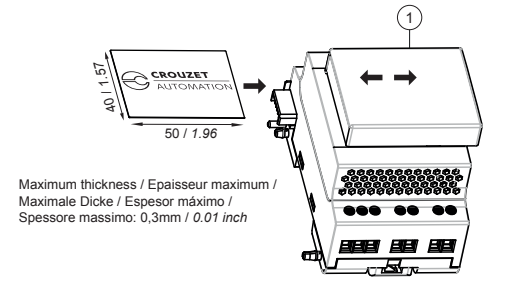

Maximum thickness / Epaisseur maximum / Maximale Dicke / Espesor máximo / Spessore massimo: 0.3mm / 0.01 inch

1 - Label holder / Support étiquette / Etikettenhalter / Portadora de etiqueta / Supporto per etichetta

Installation conditions / Conditions d'installation / Einbaubedingungen / Condiciones de instalación / Requisiti di installazione

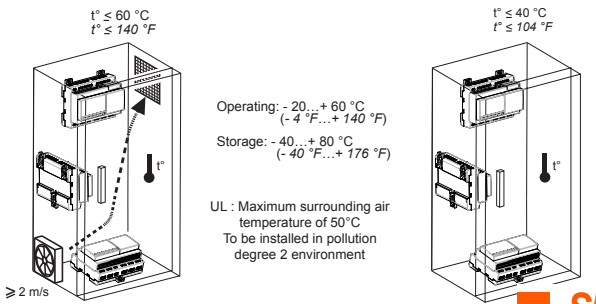

≥ 2 m/s

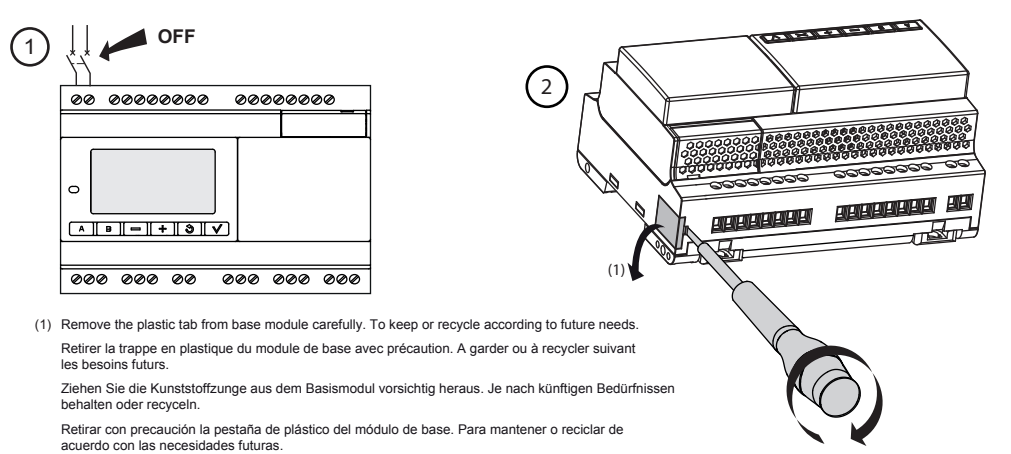
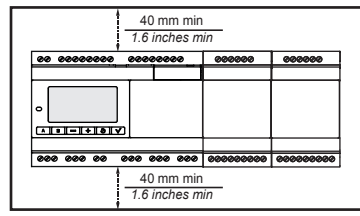

- (1) Remove the plastic tab from base module carefully. To keep or recycle according to future needs. Retirer la trappe en plastique du module de base avec précaution. A garder ou à recycler suivant les besoins futurs. Ziehen Sie die Kunststoffzunge aus dem Basismodul vorsichtig heraus. Je nach künftigen Bedürfnissen behalten oder recyceln. Retirar con precaución la pestaña de plástico del módulo de base. Para mantener o reciclar de acuerdo con las necesidades futuras. Togliere la mascherina in plastica dal modulo di base con estrema precauzione. Conservare per esigenze future o smaltire

