



Luminescence sensor High Sensitivity - Extended range



Operating Instructions

CAUTIONS AND WARNINGS

	 CAUTION
	<ul style="list-style-type: none">● The UV LED during operation radiates intense UV light.● Do not look directly into the UV light during operation of device. This can be harmful to the eyes even for brief periods due to the intense UV light.● If viewing the UV light is necessary, please use UV filtered glasses to avoid damage by the UV light.● If the UV LED in this product may be viewed directly, please affix a caution label to that effect. <p>Avoid direct eye exposure to UV light. Keep out of reach of children</p>

CAUTION: The discrete output must not be connected to outputs from other sensors (i.e. outputs from multiple sensors must not be connected in parallel). Parallel connections may damage sensor output circuitry.

IMPORTANT:

This product is an accessory or part of a system. Always read and follow the manufacturer's instructions for the equipment before connecting this product. Comply with all applicable codes and safety regulations. Failure to do so may result in damage, injury or death.

Langue Française Attention:

- La LED UV rayonne la lumière UV intense lors du fonctionnement.
- N'examinez pas directement la lumière UV lors du fonctionnement de dispositif. Ceci peut être nocif aux yeux, même pour la brève période due à la lumière UV intense.
- Si le visionnement de la lumière UV est nécessaire, employez svp les verres filtrés UV pour éviter des dommages d'oeil par la lumière UV.
- Évitez l'exposition directe d'oeil à la lumière UV.

Substance hors de l'extension des enfants.

CERTIFICATIONS: CE, CSA, UL

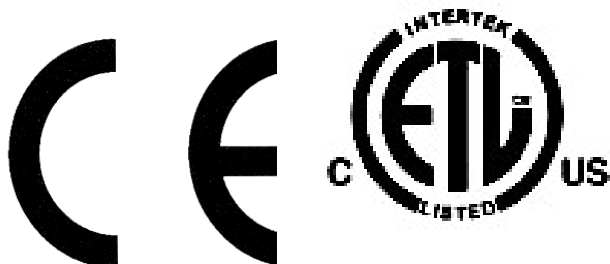

PRODUCT OVERVIEW

The UVX-600G-C sensor effectively detects UV luminescent materials and markers. The modulated UV light source in the UVX-600G-C is directed toward a target and the visible light, resulting from the fluorescence of the material, is reflected back to the sensor. When the reflected light level exceeds the threshold the discrete output changes state. Due to the fast response of the sensor, it is suitable for use in high-speed applications. The sensor provides both an analog and a discrete output. The analog output signal has a 0 to 5 V range with 20mV resolution. A PLC or a computer can be used to process the analog output and monitor the status of the discrete output signal.

The UVX-600G-C is a reliable, compact sensor with high sensitivity and extended range sensing capabilities. Two seven segment displays provide visual representation of the relative intensity from 00 to 99. Calibration feature and 3 LED intensity settings provide for flexible operation over wide range of distances and materials.

Specifications

UV light source	370nm UV LED, min.100,000 hours
LED Intensity	3 levels
Relative Intensity Display Range	00 to 99
Sensitivity	Adjustable
Detection Range	Up to 700mm
Switching Frequency	6 kHz
Brightness level	Two 7 segment digits
Brightness threshold	Two 7 segment digits
<hr/>	
Analog Output	0 - 5 V (20mV resolution)
<hr/>	
Digital Output	Auto-Detect PNP / NPN
Extend Output Pulse	0 - 90 mS (10 steps)
Output Function	NO/NC selectable
On/Off Delay	<150 uS
Security	Remote LOCK / UN-LOCK
Power indicator	Green LED
Detect indicator	Red LED
Programming indicator	Yellow LED
<hr/>	
Data retention	EEPROM non-volatile memory
<hr/>	
Dimensions	2.0"(51mm) x 2.4"(61mm) x 0.9"(23mm)
Weight	0.21 lbs. (95 g)
Supply Voltage	10...24 VDC
Operating Current	60 mA
Short Circuit Protection	Yes (Outputs)
Overload / Reverse Polarity Protection	Yes (Supply Voltage)
Operating temperature	-20°C...55°C
Storage temperature	-20°C...70°C
Housing	Metal alloy
Mechanical protection	IP65 NOT FOR PRESURE WASHDOWN

QUICKSTART GUIDE

1. The display range is 00 through 99. The decimal points indicate the LED intensity level. The RED LED above the display indicates that the intensity level exceeds the threshold setting.
2. Connect cable to power supply observing correct polarity. Reference wiring diagram.
3. Apply power; sensor will initialize and perform its power up sequence.
4. The relative intensity will be displayed. By aiming the sensor away from any objects the display will indicate 00. Aim the sensor at a white piece of paper and the display will indicate an intensity measurement. Move the paper further away from the sensor to decrease the intensity level.
5. Various adjustments may be made to increase or decrease sensitivity; refer to the Selections Calibration Adjustment and LED Intensity Level. Refer to Section: Threshold, to after threshold setting.
6. User programmable parameters are discussed in detail in the following sections.

OPERATION

Power up

Upon power up, the sensor initializes by turning on all segments on the display and sequencing through red, yellow and green on the status LED located above the display.

Intensity display mode

During normal operation the sensor display will indicate the relative intensity of a target within its field of view. The range of the relative intensity display is 00 through 99. The decimal points on the display indicate the LED output intensity. No decimal points indicate low, one decimal point indicates medium and two decimal points indicate high intensity.

Calibration Adjustment

The calibration feature allows the displayed measurement to be adjusted to the desired value by the user.

Adjusting the measured value:

1. Place target in sensor's field-of-view. The sensor will display the current reading.
2. Press either key (for less than 3 seconds); while the current reading is displayed the value is flashed slowly indicating that the sensor is in the adjustment mode.
3. Press T/+ to increment the reading and P/- to decrement the reading.
4. Stop pressing either key and sensor returns to normal operating mode in 3 seconds.

Note:

- While adjusting the reading, when a limit is reached the display flashes at a faster rate.
- The selected gain is stored in memory and is retained when power is removed.

Local Lock

The local lock feature allows the sensor to be locked out, preventing adjustments by unauthorized

personnel. To lock the sensor, press the **P/-** and **T/+** buttons for 3 seconds until **LL** is displayed. To un-lock the sensor, press the **T/+** and **P/-** for 3 seconds until **LL** is not displayed. While the sensor is locked, pressing either **P/-** or **T/+** will result in **LL** (Local Lock) indication on the display.

Programmable Parameters

All adjustments made to these parameters are stored in memory and are retained when power is removed. To enter programming mode press and hold the **P/-** key for several seconds, the current threshold setting will be displayed. Press and release the **P/-** key to scroll through the various settings. Press and release the **T/+** key to change a particular setting. Press and hold the **P/-** for several seconds to return to the normal intensity display mode. The user programmable items are described below.

Threshold

When the relative intensity level exceeds the threshold setting the red status LED will turn on and the discrete output will activate, indicating detection of the target. When the relative intensity level drops below the threshold (as determined by the hysteresis setting), the red LED will extinguish and the discrete output will de-activate. The threshold setting allows the user to select the detection level. The default setting is 15.

To adjust the threshold, enter programming mode, press and hold the **P/-** key for several seconds, the current threshold setting will be displayed. Press and release the **T/+** key to increase the threshold level, to decrease the threshold level, continue to hold the **T/+** key until the value approaches 99 then wraps around to 00.

LED Intensity Level (U)

The LED intensity is indicated on the display as U1, U2 and U3 for low, medium and high intensity. Press and release the **T/+** key to toggle through the 3 intensity levels. The default setting is U2, medium intensity.

Hysteresis Level (H)

The hysteresis setting is indicated by H0 through H9. The hysteresis level is how far below the threshold the signal must fall to de-activate or un-detect. The hysteresis can be set from 0 to 9. For example, if the threshold is set at 25 and the intensity exceeds 25, the sensor will detect and activate its output. With the hysteresis set to 5, the signal must drop to 20 to un-detect. This feature is useful in cases where there may be variation within a target that might cause the intensity to drop below the threshold slightly; the hysteresis allows the output to remain activated until the level drops significantly. Press and release the **T/+** key to change the hysteresis setting. The default setting is 2.

Discrete Output Configuration

This setting allows the user to select either normal open (no) or normally closed (nc) configuration. The normally open configuration de-activates the output during normal un-detect operation, and activates the output upon detect. The normally closed configuration activates the output during normal un-detect operation, and de-activates the output upon detect. Press and release the **T/+** key to toggle through the selections. Default is normally open.

Extend Output Pulse (P)

This feature allows extending the minimum length of time that the discrete output remains active following target detection. The sensor response can be in the 100uS (microsecond) range, i.e. a target can move through the sensing range in 100uS and the discrete output would active for only that duration. A slower acquisition system (PLC) may not sample its inputs at a fast enough rate to capture the signal. The discrete output pulse can be extended from 0 to 90mS (milliseconds) in 10 mS increments as indicated by P0 though P9 on the display. Press and release the **T/+** key to toggle through the selections.

Null Offset (nu)

NOTE: Always perform the null function when installing or removing optional lens or changing LED intensities.

The null feature allows the sensor to be “zeroed”. For example, when the target is not in view and there is a background that causes a reading above zero, the null feature allows this level to be subtracted out, allowing the display to indicate 00. Press and hold the **T/+** key to null the sensor. The display will flash the value that is being subtracted. To set the sensor back to a true zero, aim the sensor away from any target and repeat the null process.

Teach Function

The teach function allows the user to set the threshold by placing a representative target located at the required distance and allowing the sensor to determine the optimum LED intensity and setting of the threshold level.

1. Press and hold the **T/+** key for several seconds until the yellow led flashes.
2. Place the target at the appropriate distance from the sensor and press the **P/-** key. The display will flash 3 times and the sensor will adjust the LED intensity level to achieve reasonable signal level. The green LED will flash.
3. Remove the target and press the **P/-** key. The display will flash 3 times.
4. Exit the teach function and return to the normal operating mode by Pressing the **T/+** key for several seconds.

When in the teach mode the LED flashes constantly, yellow, green or red. Yellow indicates that the sensor is ready to be taught the Detect level. Green indicates that the sensor is ready to be taught the Undetect level. Red indicates that the last attempt to teach resulted in an error. If the error occurred during the teaching of the Detect level then the signal intensity was less than 01. If the error occurred during the teaching of the Undetect level, then the signal intensity was greater than or equal to the threshold level. In either case, repeat the teach function to properly set the levels.

Output Signals

Discrete Output

The discrete output is a PNP/NPN configuration allowing the user to provide a load on this output that is either pulled high to VDC or low to ground. The sensor monitors this level and automatically determines whether to operate the PNP/NPN driver. This output is typically connected to a PLC. The output remains active as long as the intensity level exceeds the threshold, in high-speed applications it may be useful to use the Extend Output Pulse feature to lengthen the signal duration to meet acquisition requirements of the PLC.

CAUTION: The discrete output must not be connected to outputs from other sensors (i.e. outputs from multiple sensors must not be connected in parallel). Parallel connections may damage sensor output circuitry.

Analog Output

The analog output is 0-5V with 20mV resolution (8-bit). Any standard analog input channel typically available on a PLC may monitor this output. The analog output signal is useful in applications where simply triggering on the threshold is insufficient. For example, constant real-time monitoring of intensity in process allows minor fluctuations or trends to be detected permitting corrective action to be taken.

Remote Lock/Unlock Input

The remote lock feature allows the user to lock out the local controls (keys) to prevent operators from making unauthorized adjustments. This signal line must be connected to VDC to lock the sensor. This line may be left unconnected if the lock feature is not used. While the sensor is locked, pressing either **P/-** or **T/+** will result in **rL** (remote Lock) indication on the display.

Display Indicators

Indicators

- Green LED Threshold Mode while in Undetect
- Red LED Detect
- Yellow LED Threshold Mode while in Detect

Display decimal points

- None illuminated LED low intensity
- One illuminated LED medium intensity
- Two illuminated LED high intensity

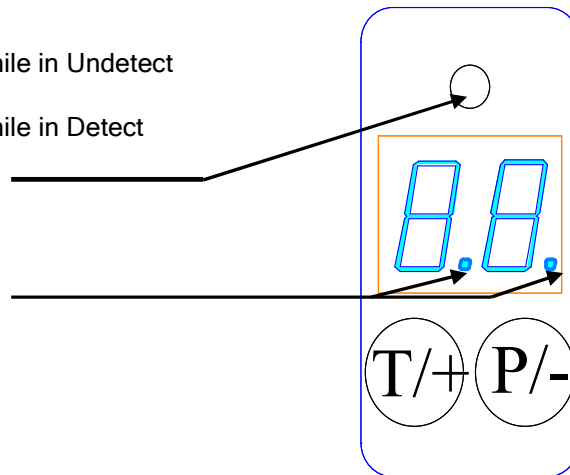

M12 connector pin assignments

M12 Connector	Wire Color	Description
Pin 1	Brown	Power 10 to 24VDC
Pin 2	White	Discrete output, PNP/NPN, NO/NC
Pin 3	Blue	Ground
Pin 4	Black	Analog output 0 to 5V DC
Pin 5	Yellow	Remote Lock (connect to sensor V+)

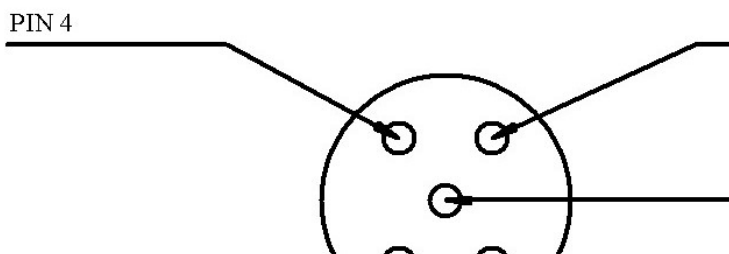

Ordering information

UVX-600G-C Luminescence sensor, extended range - high sensitivity

Accessories



UVX300-BRKT
Bracket



UVX 300-C
5 meter cable with M12
5-pin connector

Dimensional Details

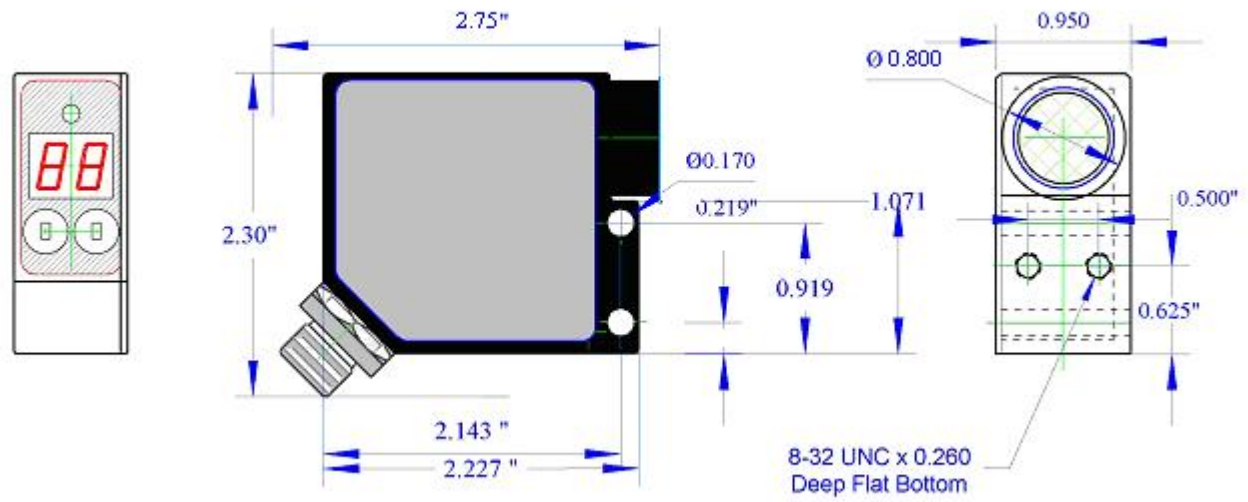

Sensor I/O Connections

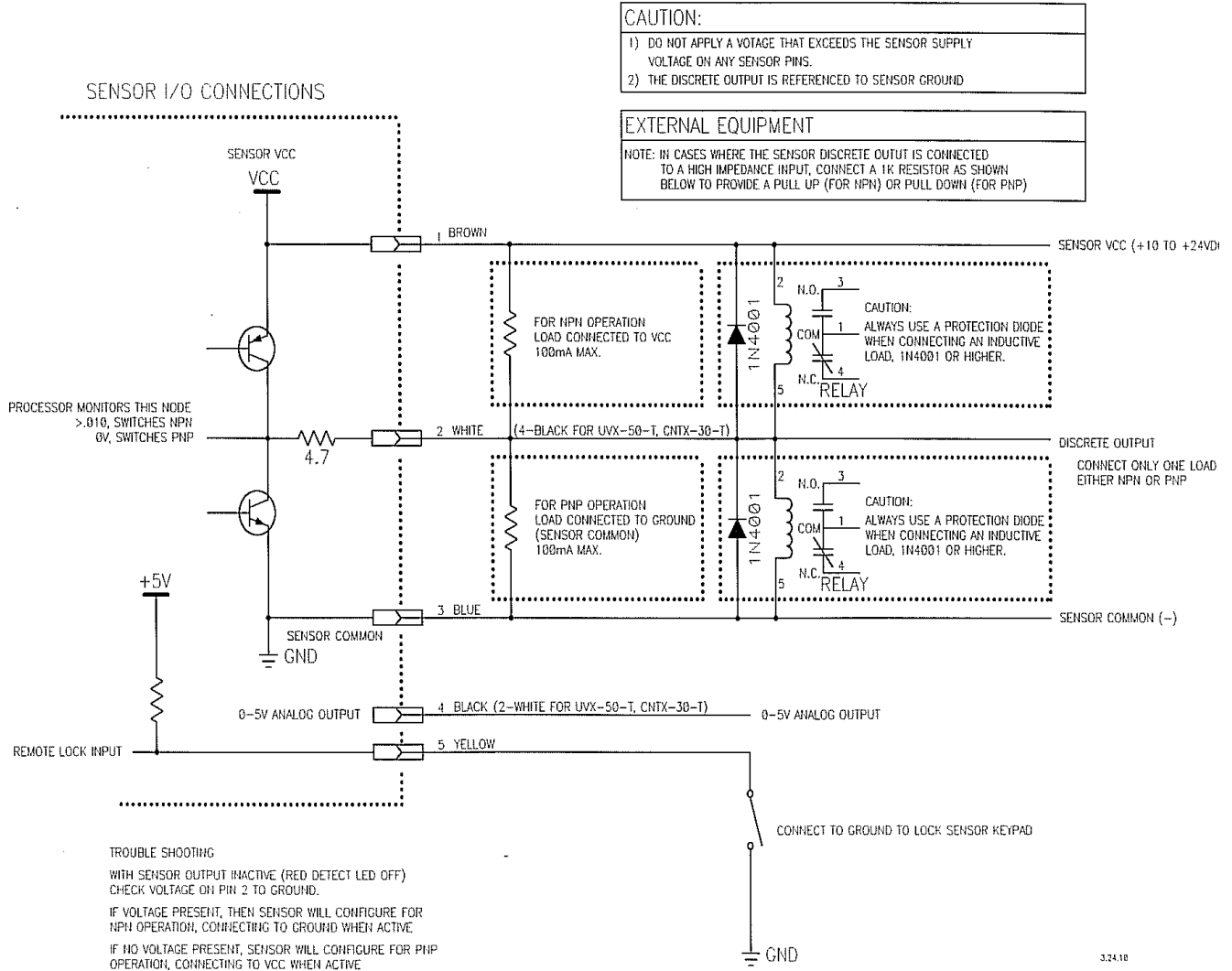

WARRANTY

EMX Industries Incorporated warrants all products to be free of defects in materials and workmanship for a period of two years under normal use and service from the date of sale to our customer. This warranty does not cover normal wear and tear, abuse, misuse, overloading, altered products, damage caused by incorrect connections, lightning damage, or use other than intended design.

There is no warranty of merchantability. There are no warranties expressed or implied or any affirmation of fact or representation except as set forth herein.

EMX Industries Inc. sole responsibility and liability, and the purchaser's exclusive remedy shall be limited to the repair or replacement at EMX Industries option of a part or parts found not conforming to the warranty. In no event shall EMX Industries Inc. be liable for damages of any nature, including incidental or consequential damages, including but not limited to damages resulting from non-conformity, defect in material or workmanship.

effective date January 1, 2002

