

PyroMini OEM Series

Operator's Guide

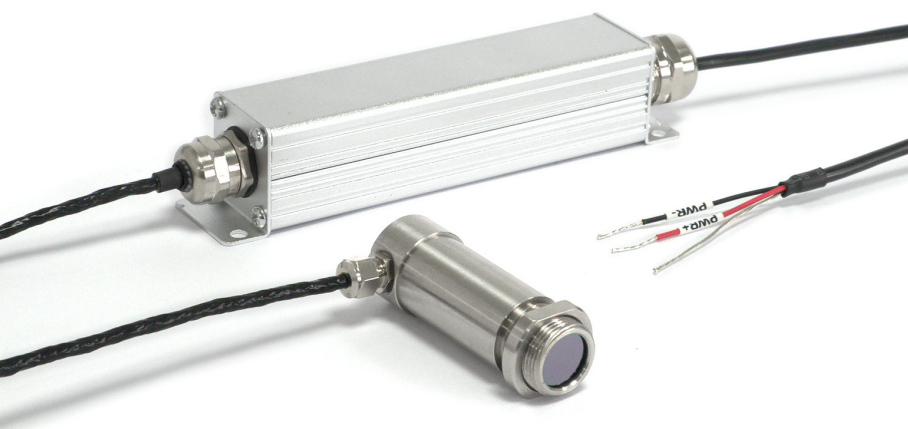

PyroMini OEM non-contact infrared temperature sensors measure temperatures from -20°C to 500°C and provide a choice of analogue outputs.

The miniature sensing head of the PyroMini OEM has a right-angled cable entry, allowing it to be installed where space is limited.

An ambient temperature rating of 0°C to 120°C allows use in applications such as dryers and curing machines where the air temperature is high.

Non-reflective, non-metallic materials such as paper, textiles, food, thick plastics, rubber, organic materials and painted surfaces can be measured accurately with the PyroMini OEM. Metal surfaces can be measured, provided they are painted or coated first.

SPECIFICATIONS

General Specifications	
Temperature Range	-20°C to 100°C (LT models) 0°C to 250°C (MT models) 0°C to 500°C (HT models)
Output	Choice of outputs: 4-20 mA, 2-wire, loop-powered, linear with temperature, 0-10 V DC, linear with temperature, Type J Thermocouple, Type K Thermocouple
Field of View	Choice of options (see Optics)
Accuracy	± 1°C or 1%, whichever is greater
Repeatability	± 0.5°C or 0.5%, whichever is greater
Emissivity Setting	Fixed at 0.95
Response Time, t90	240 ms (90% response)
Spectral Range	8 to 14 µm
Voltage (at Sensor)	12 to 28 V DC (for 0-10 V DC models) 8 to 28 V DC (for all other models)
Maximum Current Draw	20 mA (normal use) / 22 mA (fault condition)
Max. Loop Impedance	900 Ω (4-20 mA output)

Mechanical Specifications	
Construction (Sensing Head)	Stainless Steel 316
Construction (Electronics Module)	Aluminium
Major Dimensions (Sensing Head)	Ø 18 x 55 mm (see Installation)
Major Dimensions (Electronics Module)	26.5(h) x 25(w) x ~130(l) mm including cable glands
Mounting (Sensing Head)	M16 x 1 mm thread Mounting nut included
Mounting (Electronics Module)	Requires four M3 screws (see Installation)
Cable Length	Sensing head cable: 3 m Output cable: 1 m as standard; up to 30 m available
Conforms to Standards	CE, RoHS

Environmental Specifications	Sensing Head	Electronics Module
Environmental Rating	IP65	IP50
Ambient Temperature Range	0°C to 120°C	0°C to 70°C
Relative Humidity	95% Non-Condensing	95% Non-Condensing

ELECTROMAGNETIC COMPATIBILITY STANDARDS

Conforms with EMC Directive EN61326-1:2013 (Electrical Equipment for Measurement, Control and Laboratory Use – **Industrial**)

OPTICS Diameter of target spot measured versus distance from sensing head at 90% energy

21 2:1 divergent optics

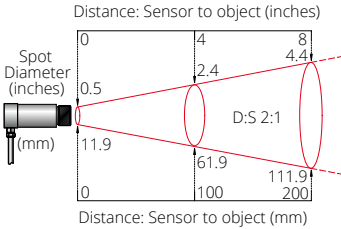

15:1 15:1 divergent optics

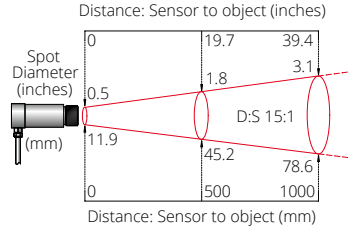

30:1 30:1 divergent optics

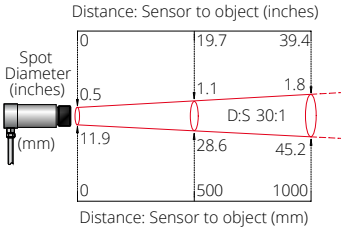

CF Close Focus optics

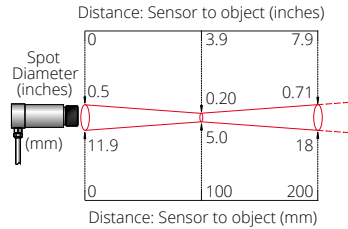

XCF Close Focus optics

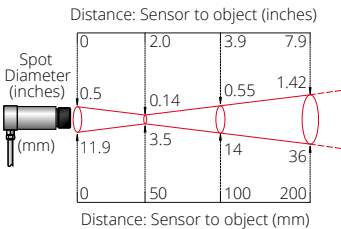

We normally recommend the target should be at least twice the size of the given measured spot for maximum accuracy.

Sensors may be used at longer distances than these diagrams show. The measured spot size will be larger at long distances.

There is no maximum measurement distance, provided the sensor's view is clear of obstructions such as steam, smoke, dust or machinery.

MODEL NUMBERS

The following combinations of optics, measured temperature range, output and sensing head cable length are available:

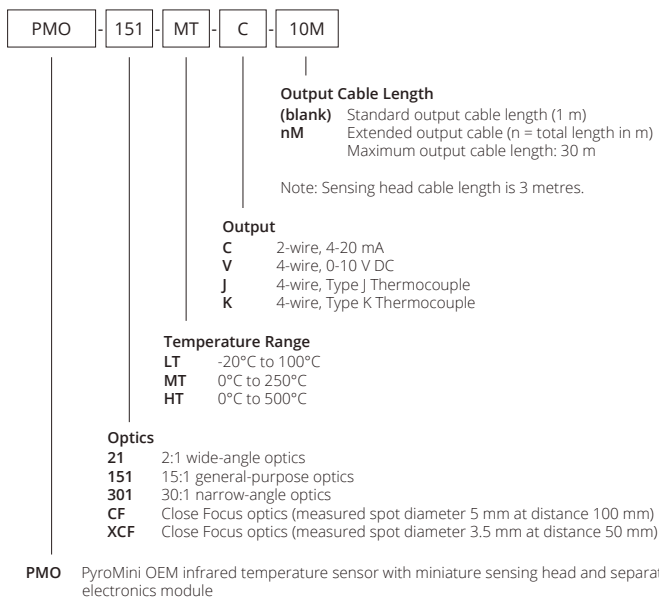

ACCESSORIES

A range of accessories to suit different applications and industrial environments is available. These may be ordered at any time and added on-site.

The following accessories are available from Calex:

- Fixed mounting bracket (see above for dimensions): Allows 1-axis rotational adjustment. Model number: **FBS**.
- Adjustable mounting bracket (see above for dimensions): Allows 2-axis rotational adjustment. Model number: **ABS**.
- Air purge collar (see above for dimensions): The air purge collar is used to keep dust, fumes, moisture, and other contaminants away from the lens. It must be screwed fully onto the sensing head. Air flows into the 1/8" BSP fitting and out of the front aperture. Air flow should be 5 to 15 l/min. Clean or 'instrument' air is recommended. Model **APSW** is for use with sensors with 2:1 optics. Model **APSN** is for use with all other models.
- Laser sighting tool: When fitted to the sensor during installation or re-alignment, the laser sighting tool pinpoints the centre of the measured spot. Model number: **LSTS**.
- Dual laser sighting bracket: Allows continuous laser sighting at the same time as using the sensor. Model number: **DLSBFS** (fixed), **DLSBAS** (adjustable)

OPTIONS

An optional Calibration Certificate is available, to be ordered at the same time as the sensor. This is a UKAS traceable certificate showing the measured temperature at three points across the sensor's temperature range. Model number: **CALCERTA**.

DIMENSIONS

Electronics Module

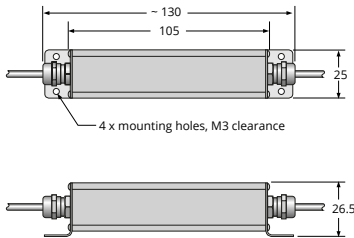

Sensing Head

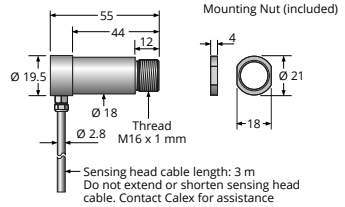

Air Purge Collar (Optional)

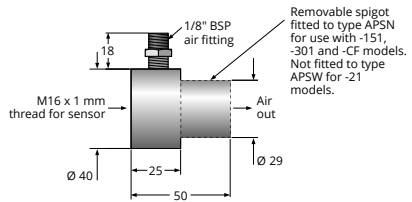

Fixed Mounting Bracket (Optional)

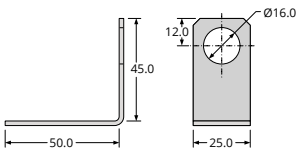

Adjustable Mounting Bracket (Optional)

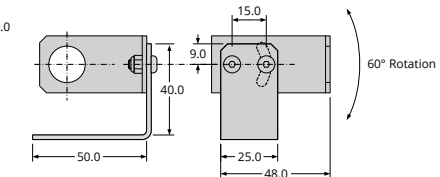

2 x mounting holes, M4 clearance

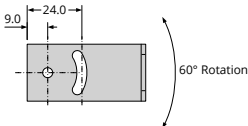

2 x mounting holes, M4 clearance

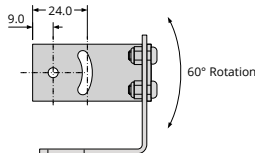

INSTALLATION

The installation process consists of the following stages:

- Preparation
- Mechanical Installation
- Electrical Installation

Please read the following sections thoroughly before proceeding with the installation.

PREPARATION

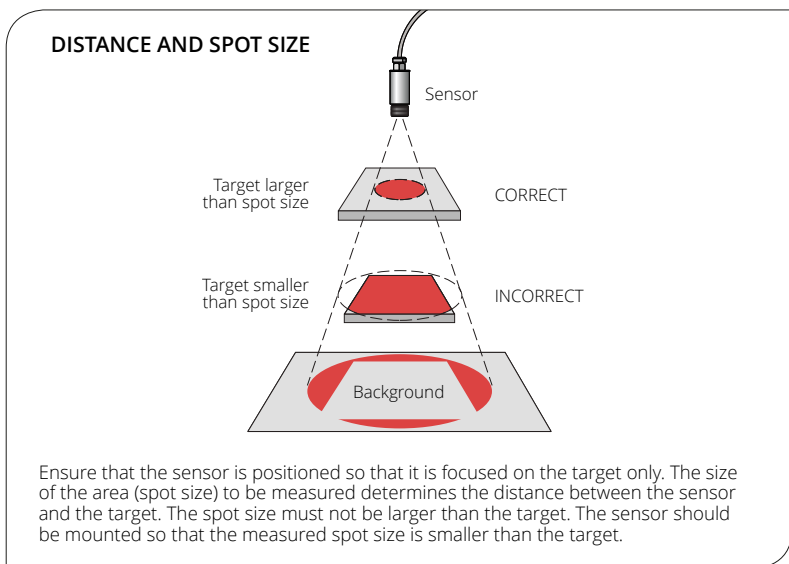

AMBIENT TEMPERATURE

The sensing head withstands up to 120°C without cooling. The electronics module must be mounted where the temperature is below 70°C. Avoid thermal shock. Allow 20 minutes for the unit to adjust to large changes in ambient temperature.

ATMOSPHERIC QUALITY

Smoke, fumes, dust or steam can contaminate the lens and cause errors in temperature measurement. In these types of environment the air purge collar should be used to help keep the lens clean.

ELECTRICAL INTERFERENCE

The PyroMini OEM is tested to industrial standards for electromagnetic compatibility (EMC) as shown in Specifications at the beginning of this manual. To minimise electromagnetic interference or 'noise', the sensor should be mounted away from motors, generators etc.

POWER SUPPLY

We recommend a 24 V DC power supply capable of 100 mA minimum. See Specifications for other possible supply voltages.

MECHANICAL INSTALLATION

All sensors come with a 3 m sensing head cable, 1 m output cable and a mounting nut as standard. Longer cables are available to order. The sensor can be mounted on brackets or cut-outs of your own design, or you can use the optional mounting bracket accessories.

Note: The sensor housing must be connected to earth at one point, either the housing of the sensing head, the electronics module, or the output cable shield termination. To avoid ground loops, please ensure the sensor is grounded at only one of these points.

WIRING (ALL MODELS)

Check the distance between the sensing head and the electronics module, and between the electronics module and the instrumentation.



Do not open the cable glands on the electronics module or sensing head. Do not attempt to extend or shorten the sensing head cable.
Contact Calex for assistance.

ELECTRICAL INSTALLATION

2-wire Models (4-20 mA Output)

Wire Tag	Function
PWR+	Power +24 V DC (4-20 mA loop)
PWR-	Power 0 V DC (4-20 mA loop)
(no tag)	Shield drain

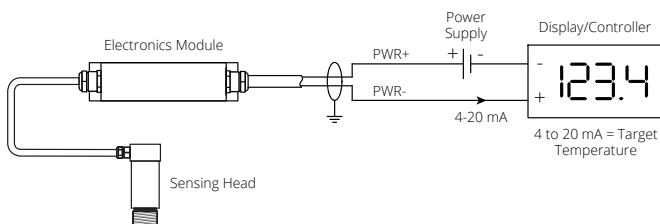

4-wire Models (Thermocouple Output)

* Sensing head internal temperature is provided as a 4-20 mA signal on the power loop. It is possible to use the sensor without measuring this signal; in that case power should be connected directly to PWR+ and PWR-.

Wire Tag	Function
PWR+	Power +24 V DC *
PWR-	Power 0 V DC *
OP+	Target temperature output +
OP-	Target temperature output -
(no tag)	Shield drain

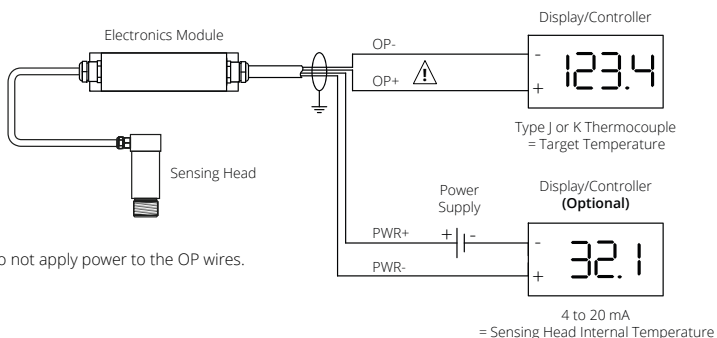

⚠ Do not apply power to the OP wires.

4-wire Models (Voltage Output)

Wire Tag	Function
PWR+	Power +24 V DC
PWR-	Power 0 V DC
OP+	Target temperature output +
OP-	Target temperature output -
(no tag)	Shield drain

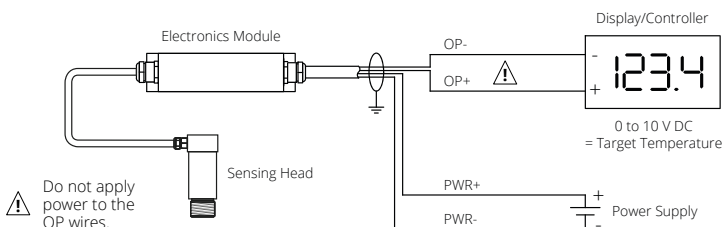

⚠ Do not apply power to the OP wires.

OPERATION

Once the sensor is in position and the appropriate power, air and cable connections are secure, the system is ready for continuous operation. To start using the sensor:

- Check all wiring connections, then turn on the sensor power supply
- Turn on the connected instrumentation
- Read, monitor or log the temperature

IMPORTANT

Be aware of the following when using the sensor:

- If the sensor is exposed to significant changes in ambient temperature (hot to cold, or cold to hot), allow 20 minutes for the temperature to stabilise before taking or recording measurements.
- Do not operate the sensor near large electromagnetic fields (e.g. around arc welders or induction heaters). Electromagnetic interference can cause measurement errors.
- Wires must be connected only to the appropriate terminals.

MAINTENANCE

Our customer service representatives are available for application assistance, calibration, repair, and solutions to specific problems. Contact our Service Department before returning any equipment. In many cases, problems can be solved over the telephone. If the sensor is not performing as it should, try to match the symptom below to the problem. If the table does not help, call Calex for further advice.

LENS CLEANING

Keep the lens clean at all times. Any foreign matter on the lens would affect measurement accuracy. Blow off loose particles (if not using the air purge accessory) with an air 'puffer'.

TROUBLESHOOTING

Symptom	Probable Cause	Solution
No output	No power to sensor	Check power supply and wiring
Inaccurate measured temperature	Target too small for sensor's field of view	Ensure the sensor's view is completely filled by the target. Position the sensor closer to the target to measure a smaller area.
	Target is a reflective metal surface	Measure a non-reflective area, or paint or coat a measurable area of the target to make it non-reflective
	Field of view obstruction	Remove obstruction; ensure sensor has a clear view of target
	Dust or condensation on lens	Ensure lens is clean and dry. Clean gently with a soft lens cloth and water. If problem recurs, consider using an air purge collar.
	Incorrect wire connections	Check wire colour codes
Erroneous temperature (mA or V outputs)	Output temperature scale mismatch	Re-scale input temperature range on measurement instrument to match sensor
Erroneous temperature (thermocouple output)	No Cold Junction Compensation (CJC) or wrong type of extension cable	Enable CJC on measurement instrument; ensure extension cable and connectors are of the correct thermocouple type

GUARANTEE

Calex guarantees each instrument it manufactures to be free from defect in material and workmanship under normal use and service for the period of two years from the date of purchase. This guarantee extends only to the original buyer according to Calex's standard Terms and Conditions of Sale.