

USER MANUAL

CLASS 320 KISTOCK

KT 320 / KCC 320 / KP 320-321

KPA 320 / KTT 320

Table of contents

1	Safety instructions.....	4
1.1	Precautions for use.....	4
1.2	Symbols used.....	4
1.3	Directive 2014/53/EU.....	4
2	Presentation of the device.....	5
2.1	Use.....	5
2.2	Applications.....	5
2.3	References.....	5
2.4	Description of the device.....	6
2.5	Description of keys.....	6
2.6	Description of LEDs.....	6
2.7	Connections.....	6
2.8	Mounting.....	6
3	Technical features.....	7
3.1	Technical features of the devices.....	7
3.2	Programmed units.....	9
3.3	Free units.....	9
3.4	Features of the housing.....	9
3.5	Features of optional probes.....	10
3.6	Dimensions (in mm).....	11
3.6.1	Devices.....	11
3.6.2	Wall mount (in option).....	11
3.7	Guarantee period.....	11
4	Use of the device.....	12
4.1	Display.....	12
4.2	Function of LEDs.....	12
4.3	Function of keys.....	13
4.3.1	Groups organisation.....	15
4.3.2	Measurements scroll.....	15
4.4	PC communication.....	16
4.5	Configuration, datalogger download and data processing with the KILOG software.....	16
5	Wireless connection function.....	17
6	Maintenance.....	17
6.1	Replace the batteries.....	17
6.2	Device cleaning.....	17
6.3	Safety lock wall mount with padlock.....	17
7	Calibration.....	18
7.1	KCC 320: perform a CO ₂ measurement verification.....	18
7.2	KP 320 – KP 321: perform an auto-zero.....	18
8	Accessories.....	19
9	Troubleshooting.....	19

1 Safety instructions

1.1 Precautions for use

Please always use the device in accordance with its intended use and within parameters described in the technical features in order not to compromise the protection ensured by the device.

1.2 Symbols used

For your safety and in order to avoid any damage of the device, please follow the procedure described in this user manual and read carefully the notes preceded by the following symbol:



The following symbol will also be used in this user manual:
Please read carefully the information notes indicated after this symbol.



1.3 Directive 2014/53/EU

Hereby, Sauermann Industrie SAS declares that the radio equipment type Kistock 320 is in compliance with Directive 2014/53/EU. The full text of the EU declaration of conformity is available at the following internet address:

www.sauermanngroup.com

2 Presentation of the device

2.1 Use

The **KISTOCK** class 320 dataloggers allow the measurement of several parameters:

- KT 320: internal measurement of temperature with two universal inputs for probe
- KCC 320: internal measurement of temperature, humidity, atmospheric pressure and CO₂
- KP 320 – KP 321: internal measurement of differential pressure with two measuring ranges
- KPA 320: internal measurement of temperature, hygrometry and atmospheric pressure
- KTT 320: model with four thermocouple inputs

Communication between device and PC is carried out with a USB cable with a micro-USB female connector.

The low-energy wireless connection (possibility to deactivate this function) allows to communicate with smartphones and tablets, working with Android and IOS.

2.2 Applications

The **KISTOCK** dataloggers are ideal for different parameters surveillance (temperature, hygrometry, light, current, voltage, impulsion, relative pressure...). They ensure the traceability in the food industry environment as well as they validate the proper functioning of industrial installations.



2.3 References

Device reference	Display	Internal sensors		External sensors		Parameters	Number of recording points
		Number	Type	Number	Type		
KT 320	Yes	1	Temperature	2	Inputs for SMART PLUG* probes	Temperature, hygrometry, current, voltage, impulsion	2 000 000
KCC 320		4	Temperature, hygrometry, atmospheric pressure, CO ₂	-		Temperature, hygrometry, atmospheric pressure, CO ₂	
KP 320 KP 321		1	Differential pressure			Differential pressure	
KPA 320		3	Temperature, hygrometry, atmospheric pressure			Temperature, hygrometry, atmospheric pressure	
KTT 320		-	-	4	Inputs for thermocouple probes	Temperature	

* Input which allows to plug different compatible SMART PLUG probes: see optional probes and cables page 10.

2.4 Description of the device



2.5 Description of keys

 **OK key:** allows to start or stop the dataset or change of scrolling group, see page 13.

 **Selection key:** allows the functions scroll, see page 13.

2.6 Description of LEDs



2.7 Connections

The communication between the device and the computer is carried out via a USB cable and with the female micro-USB connector.



KT 320: 2 mini-DIN connections

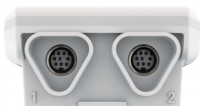

KP 320 and KP 321: 2 pressure connections



KCC 320 and KPA 320



KTT 320: 4 mini-thermocouple connections



2.8 Mounting

The class 320 KISTOCK has magnetic mountings, so you can fix it easily.

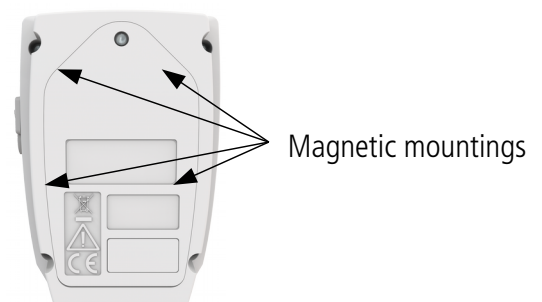

3.1 Technical features of the devices

	KT 320	KTT 320
Units displayed	°C, °F, °Ctd, °Ftd, %RH, mV, V, mA, A Programmed and free units are also available ¹ (see table page 9)	°C, °F
Resolution	0.1°C, 0.1°F, 0.1%RH, 1 mV, 0.001 V, 0.001 mA, 0.1 A	0.1°C, 0.1°F
External input	Female micro-USB connector	
Input for probe	2 SMART PLUG ² inputs	4 inputs for thermocouple probes (K, J, T, N, S)
Internal sensor	Temperature	-
Type of sensor	CTN	Thermocouple
Measuring range	Measuring range of the internal sensor ³ : From -40 to +70°C	K: from -200 to +1300°C J: from -100 to +750°C T: from -200 to +400°C N: from -200 to +1300°C S: from 0 to 1760°C
Accuracy⁴	±0.4°C from -20 to 70°C ±0.8°C below -20°C	K, J, T, N: ±0.4°C from 0 to 1300°C ±(0.3% of the reading +0.4°C) below 0°C S: ±0.6°C
Setpoints alarm	2 setpoint alarms on each channel	
Frequency of measurements	From 1 second to 24 hours	
Operating temperature	From -40 to +70°C	From -20 to 70°C
Storage temperature	From -40 to +85°C	
Battery life	7 years ⁵	
European directives	2011/65EU RoHS II; 2012/19/EU WEEE; 2014/30/EU EMC; 2014/35/EU	

¹ Some units are available only with optional probes.

² Input which allows to plug different SMART PLUG compatible probes: see optional probes and cables page 10.

³ Other measuring ranges are available according to the connected probe: see optional probes and cables page 10.

⁴ All accuracies indicated in this document were stated in laboratory conditions and can be guaranteed for measurement carried out in the same conditions, or carried out with calibration compensation.

⁵ On the basis of 1 measurement each 15 minutes at 25°C.

	KCC 320	KPA 320
Units displayed	°C, °F, %RH, hPa, ppm	°C, °F, %RH, hPa
Resolution	0.1°C, 1 ppm, 0.1%RH, 1 hPa	0.1°C, 0.1%RH, 1hPa
External input	Micro-USB female connector	
Input for probe	-	-
Internal sensor	Hygrometry, temperature, atmospheric pressure, CO ₂	Hygrometry, temperature, atmospheric pressure
Tolerated overpressure	-	1260 hPa
Type of sensor	<u>Temperature and hygrometry</u> : capacitive <u>Atmospheric pressure</u> : piezo-resistive <u>CO₂</u> : NDIR	<u>Temperature and hygrometry</u> : cpacitive <u>Atmospheric pressure</u> : piezo-resistive
Measuring range	<u>Temperature</u> : from -20 to 70°C <u>Hygrometry</u> : from 0 to 100%RH <u>Atmospheric pressure</u> : from 800 to 1100 hPa <u>CO₂</u> : from 0 to 5000 ppm	<u>Temperature</u> : from -20 to 70°C <u>Hygrometry</u> : from 0 to 100%RH <u>Atmospheric pressure</u> : from 800 to 1100 hPa
Accuracy*	<u>Temperature</u> : ±0.4°C from 0 to 50°C ±0.8°C below 0°C or above 50°C <u>Humidity**</u> : ±2%RH from 5 to 95%, 15 to 25°C <u>Atm. pressure</u> : ±3 hPa <u>CO₂</u> : ±50 ppm ±3% of the reading	<u>Temperature</u> : ±0.4°C from 0 to 50°C ±0.8°C below 0°C or above 50°C <u>Humidity**</u> : ±2%RH from 5 to 95%, 15 to 25°C <u>Atm. pressure</u> : ±3 hPa
Setpoints alarm	2 setpoint alarms on each channel	
Frequency of measurements	From 1 minute to 24 hours (15 sec in on-line mode)	From 1 second to 24 hours
Operating temperature	From 0 to +50°C	
Storage temperature	From -40 to +85°C	
Battery life	3 years***	7 years***
European directives	2011/65EU RoHS II; 2012/19/EU WEEE; 2014/30/EU EMC; 2014/35/EU	

* All accuracies indicated in this document were stated in laboratory conditions and can be guaranteed for measurement carried out in the same conditions, or carried out with calibration compensation.

** Factory calibration uncertainty: ±0.88%RH. Temperature dependence: ±0.04 x (T-20) %RH (if T<15°C or T>25°C)

*** On the basis of 1 measurement each 15 minutes at 25°C.

	KP 320	KP 321
Units displayed	Pa	
Measuring range	±1000 Pa	±10000 Pa
Resolution	1 Pa	
Accuracy*	±0.5% of the reading ±3 Pa	±0.5% of the reading ±30 Pa
Tolerated overpressure	21 000 Pa	69 000 Pa
External input	Micro-USB female connector	
Input for probe	2 pressure connections	
Internal sensor	Differential pressure	
Setpoints alarm	2 setpoint alarms on each channel	
Frequency of measurement	From 1 second to 24 hours	
Operating temperature	From 5 to +50°C	
Storage temperature	From -40 to 85°C	
Battery life	7 years**	
European directives	2011/65EU RoHS II; 2012/19/EU WEEE; 2014/30/EU EMC; 2014/35/EU	

* All accuracies indicated in this document were stated in laboratory conditions and can be guaranteed for measurement carried out in the same conditions, or carried out with calibration compensation.

** On the basis of 1 measurement each 15 minutes at 25°C.

3.2 Programmed units

The available programmed units for the KT 320 and KTT 320 KISTOCK are the following:

- m/s
- °C
- PSI
- mmHg
- °Ctd
- mA
- tr/
- ppm
- fpm
- °F
- Pa
- mbar
- °Ftd
- A
- min
- m³/s
- %HR
- mmH₂O
- g/Kg
- °Ctw
- mV
- rpm
- K
- inWg
- bar
- °Ftw
- V
- kPa
- hPa
- kj/kg
- Hz
- daPa

3.3 Free units

For the free units creation, please see the **KILOG software** user manual.

3.4 Features of the housing

Dimensions	110.2 x 79 x 35.4 mm
Weight	KT 320, KCC 320, KP 320, KP 321: 206 g. KTT 320 and KPA 320: 200 g.
Display	2 lines LCD screen. Screen size: 49.5 x 45 mm 2 indication LEDS (red and green)
Control	1 OK key 1 Selection key
Material	Compatible with food industry environment ABS housing
Protection	IP65: KT 320, KP 320 and KP 321* IP 54: KTT 320** IP40: KCC 320 and KPA 320
PC communication	Micro-USB female connector USB cable
Battery power supply	2 double AA lithium 3.6 V batteries
Environmental conditions of use	Air and neutral gases Hygrometry: en conditions de non-condensation Altitude: 2000 m

* With the pressure connectors plugged for KP 320 and KP 321.

** With all the thermocouple probes connected.

3.5 Features of optional probes



All the probes for the **KT 320** KISTOCK have the **SMART PLUG** technology. An automatic recognition and the adjustment make them 100% interchangeable.

Reference	Description	Measuring range
<i>External or ambient thermo-hygrometric probes</i>		
KITHA	Interchangeable hygrometry and ambient temperature probe	Hygrometry: from 0 to 100%HR
KITHP-130	Remote interchangeable hygrometry and temperature probe	Temperature: from -20 to +70°C
KITHI-150	Remote interchangeable hygrometry and temperature probe	Hygrometry: from 0 to 100%HR Temperature: from -40 to +180°C
<i>General use or insertion Pt 100 temperature probes</i>		
KIRGA-50 / KIRGA-150	IP65 immersion probe (50 or 150 mm)	From -40 to +120°C
KIRAM-150	Ambient probe 150 mm	
KIRPA-150	Penetration probe IP65	
KIPI3-150-E	IP68 penetration probe with handle	From -50 to +250°C
KITI3-100-E	IP68 penetration probe with T-handle	
KITBI3-100-E	IP68 penetration probe with corkscrew handle	
KIRV-320	Velcro probe	From -20 to +90°C
KICA-320	Smart adapter for Pt100 probe	From -200 to +600°C according to the probe
<i>Input current, voltage and impulsion cables</i>		
KICT	Voltage input cable	0-5 V or 0-10 V
KICC	Current input cable	0-20 mA or 4-20 mA
KICI	Pulse input cable	Maximal voltage: 5 V Type of input: TTL frequency counting Maximal frequency: 10 kHz Maximum number of recordable points: 20 000 points
<i>Clamp-on ammeters</i>		
KIPID-50	Ammeter clamp from 0 to 50 A, frequency range from 40 to 5000 Hz	From 0 to 50 A _{AC}
KIPID-100	Ammeter clamp from 0 to 100 A, frequency range from 40 to 5000 Hz	From 1 to 100 A _{AC}
KIPID-200	Ammeter clamp from 0 to 200 A, frequency range from 40 to 5000 Hz	From 1 to 200 A _{AC}
KIPID-600	Ammeter clamp from 0 to 600 A, frequency range from 40 to 5000 Hz	From 1 to 600 A _{AC}
<i>Thermocouple probes</i>		
All the thermocouple temperature probes for the KTT 320 KISTOCK have a class 1 sensitive element as per IEC 584-1, 2 and 3 standards. For more details about the available thermocouple probes, please see the "Thermocouple probes" datasheet.		

For more details, please see the "Measuring probes for KT 320 KISTOCK" and "Thermocouple probes" datasheets.

Connect a probe:

- Open the mini-DIN connection cap on the bottom of the KISTOCK.
- Connect the probe in such a way the mark on the probe is in front of the user.



3.6 Dimensions (in mm)

3.6.1 Devices

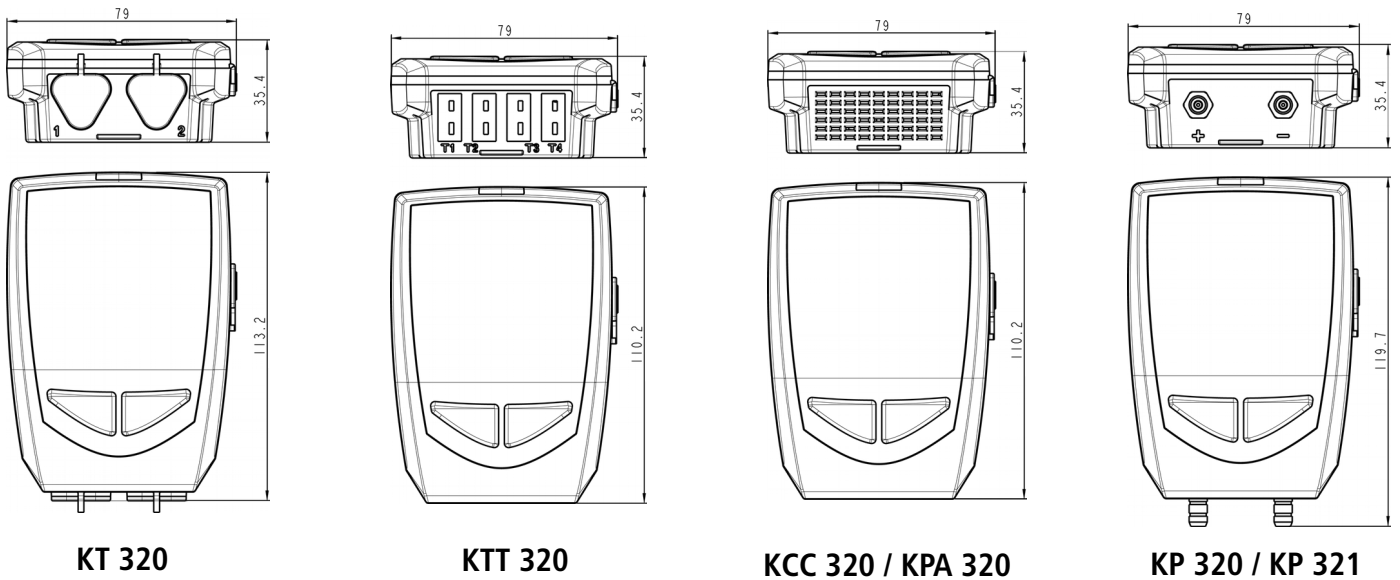

3.6.2 Wall mount (in option)

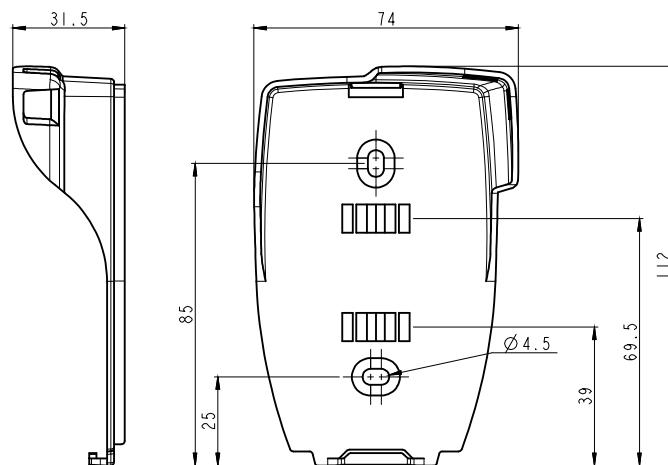

3.7 Guarantee period

KISTOCK dataloggers have 1-year guarantee for any manufacturing defect (return to our After-sales service required).

4.1 Display

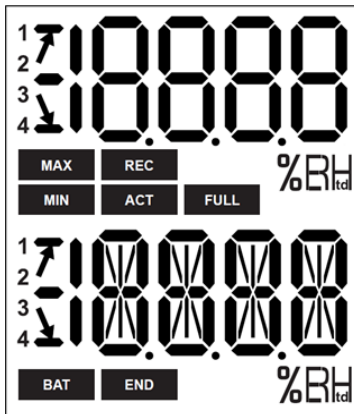

END DATASET is finished.



REC Indicates that one value is being recorded.
It flashes: the DATASET did not start already.

FULL Flashing slowly: DATASET is between 80 and 90% of the storage capacity.
Flashing quickly: DATASET is between 90 and 100% of the storage capacity.
Constant: storage capacity full.

BAT Constant: indicates that the batteries have to be replaced.

ACT Screen actualisation of measured values.

MIN
MAX The displayed values are the maximum/minimum values recorded for the channels displayed.



 Indication of the direction of exceeding the
 threshold in the recorded measurement

1 Indicates the channel number which is
2 measuring.
3
4

 Temperature in °Celsius.

 Temperature in °Fahrenheit .

 Relative humidity

-  The selected values to display during the configuration with the KILOG software will scroll on the screen every 3 seconds.
-  The display can be activated or deactivated via the KILOG software.
-  At extreme temperatures, the display can become hardly readable and its display speed can slow down at temperatures below 0°C. This has no incidence on the measurement accuracy.

4.2 Function of LEDs



Alarm LED

If the red "Alarm" LED has been activated, it has 3 states:

- **Always OFF:** no setpoint alarms has been exceeded
- **Flashing quickly (5 seconds):** a threshold is currently exceeded on one channel at least
- **Flashing slowly (15 seconds):** at least one threshold has been exceeded during the dataset

Operating LED

If the green "ON" LED has been activated, it flashes every 10 seconds during the recording period.



















4.3 Function of keys







OK key: allows to start, stop the dataset or change of scrolling group like described in the following tables.

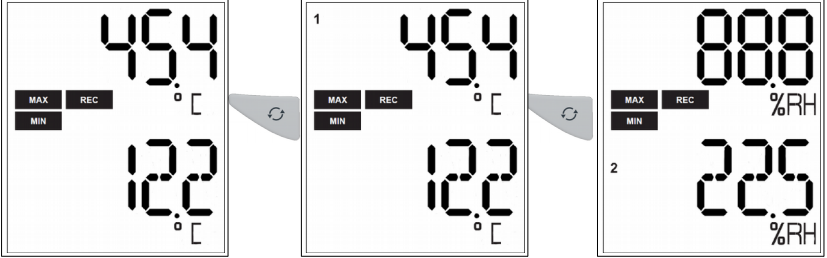

Selection key: allows the scroll values in the scrolling group like described in the following tables.

Device state	Type of start/stop selected	Key used	Action generated	Illustration
Waiting for start  flashes	Start: by button	 During 5 seconds	Start of dataset	  5 seconds
	Stop: indifferent		Inactive	
	Start: by PC, date/time		Inactive	
	Stop: indifferent			
	Start: indifferent		Measurements scroll (group 1)*	 
	Stop: indifferent			
Dataset in progress 	Start: indifferent	 During 5 seconds	Stop of the dataset	  5 seconds
	Stop: by button			
	Start: indifferent		Group change (groups 2 and 3)*	  
	Stop: indifferent			

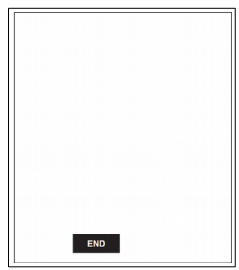
* Please see the summary table of the groups organisation page 15.

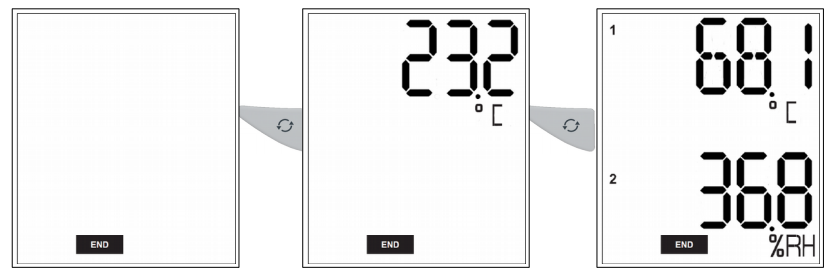





Device state	Type of start/stop selected	Key used	Action generated	Illustration
	Start: indifferent Stop: indifferent		Group scrolling (groups 1, 2 and 3)*	
Dataset finished END	Indifferent		Inactive	
	Indifferent		Measurements scroll*	

* Please see the summary table of the groups organisation on the following page.

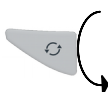
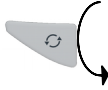
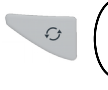
4.3.1 Groups organisation

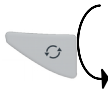
The table below summarises the groups organisation and measured values available during a measurement dataset.



	Group 1	Group 2	Group 3
	Measured temperature*	Max. value in temperature Min. value in temperature	High alarm threshold in temperature Low alarm threshold in temperature
	Measured hygrometry*	Max. value in hygrometry Min. value in hygrometry	High alarm threshold in hygrometry Low alarm threshold in hygrometry
	Measured CO ₂ *	Max. value in CO ₂ Min. value in CO ₂	High alarm threshold in CO ₂ Low alarm threshold in CO ₂
	Measured differential pressure*	Max. value in differential pressure Min. value in differential pressure	High alarm threshold in differential pressure Low alarm threshold in differential pressure
	Measured atmospheric pressure*	Max. value in atmospheric pressure Min. value in atmospheric pressure	High alarm threshold in atmospheric pressure Low alarm threshold in atmospheric pressure
	Parameter 1 of probe 1*	Max. value in Parameter 1 of probe 1 Min. value in Parameter 1 of probe 1	High alarm threshold in Parameter 1 of probe 1 Low alarm threshold in Parameter 1 of probe 1
	Parameter 2 of probe 1*	Max. value in Parameter 2 of probe 1 Min. value in Parameter 2 of probe 1	High alarm threshold in Parameter 2 of probe 1 Low alarm threshold in Parameter 2 of probe 1
	Parameter 1 of probe 2*	Max. value in Parameter 1 of probe 2 Min. value in Parameter 1 of probe 2	High alarm threshold in Parameter 1 of probe 2 Low alarm threshold in Parameter 1 of probe 2
	Parameter 2 of probe 2*	Max. value in Parameter 2 of probe 2 Min. value in Parameter 2 of probe 2	High alarm threshold in Parameter 2 of probe 2 Low alarm threshold in Parameter 2 of probe 2

Press  key to change of group.

Press  key to scroll values in the group.

4.3.2 Measurements scroll

According to the selected parameters during the configuration and according to the type of device, the measurement scroll is carried out like following:

Temperature* ➡ Hygrometry* ➡ CO₂* ➡ Differential pressure* ➡ Atmospheric pressure* ➡ Parameter 1 probe 1* ➡ Parameter 2 probe 1* ➡ Parameter 1 probe 2* ➡ Parameter 2 probe 2*

* Parameters available according to the device and probe type

Examples:

- KT 320 KISTOCK with a thermo-hygrometric probe (channel 1) and a temperature probe (channel 2):

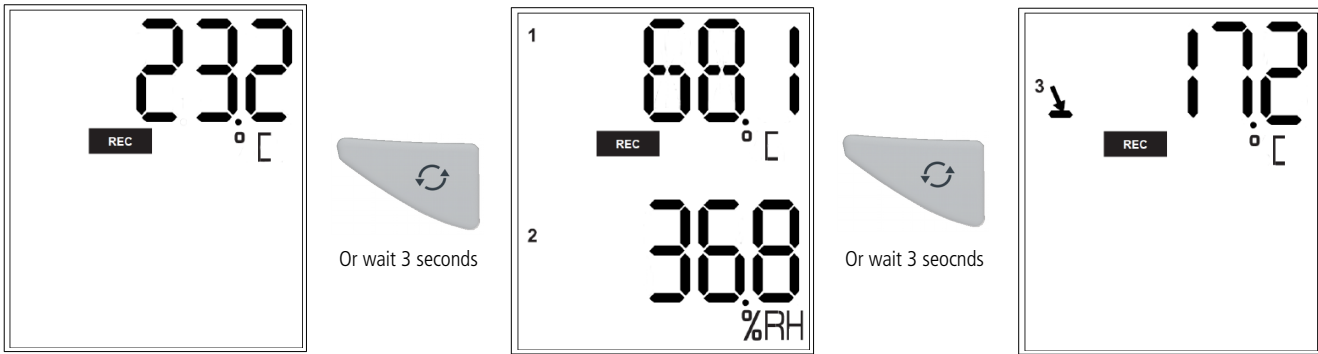

- KCC 320 KISTOCK:

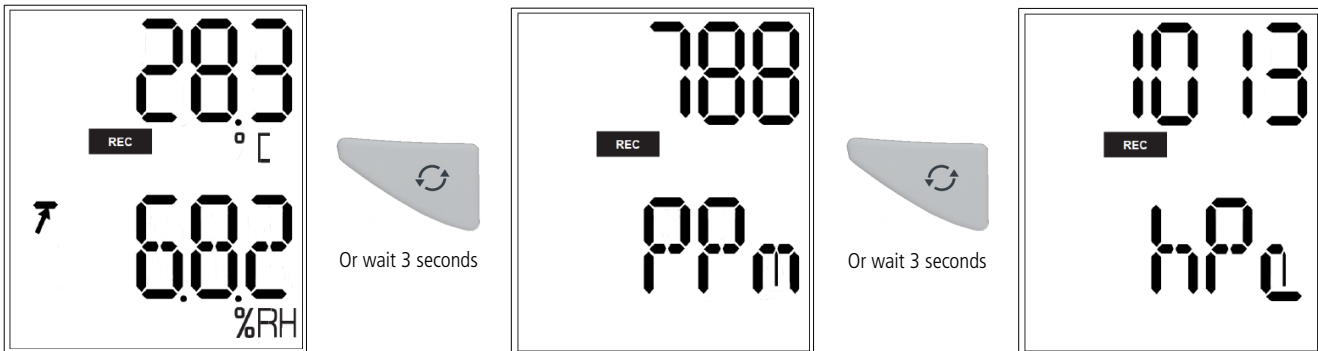

The measurements scroll can be carried out by pressing the "Select" button of the datalogger or wait about 3 seconds and the display scrolls automatically.

4.4 PC communication

- Insert the CD-ROM in the reader and follow the installation procedure of the **KILOG** software.

 1. Plug the male USB connector of the cable to an USB connection on your computer*.
 2. Open the USB cap on the right side of the datalogger.
 3. Connect the male micro-USB connector of the cable to the female micro-USB connector of the device.



4.5 Configuration, datalogger download and data processing with the KILOG software

Please see the **KILOG** software user manual: "KILOG-classes-50-120-220-320".



The date and time updates automatically when a new configuration is loaded.

*The computer must be in compliance with the IEC60950 standard.

5 Wireless connection function

Kistocks of the class 320 has the wireless connection function allowing to communicate with a smartphone or a tablet (Android or iOS) via the Kilog Mobile application.

The Kistock is named "**Kistock 320**" in the list of available devices of the tablet or smartphone.

By default, the wireless connection is disabled on class 320 Kistocks. Please see the Kilog software applications user manuals to enable it.

6 Maintenance

6.1 Replace the batteries

With a 3 to 7 years battery life*, the KISTOCK guarantees long-term measurement.

To replace batteries:

1. Unscrew the unlosable screw on the battery hatch on the backside of the KISTOCK with a cross-head screwdriver.
2. The battery hatch opens. Remove the old batteries.
3. Insert the new batteries and check the polarity.
4. Replace the battery hatch and screw it.

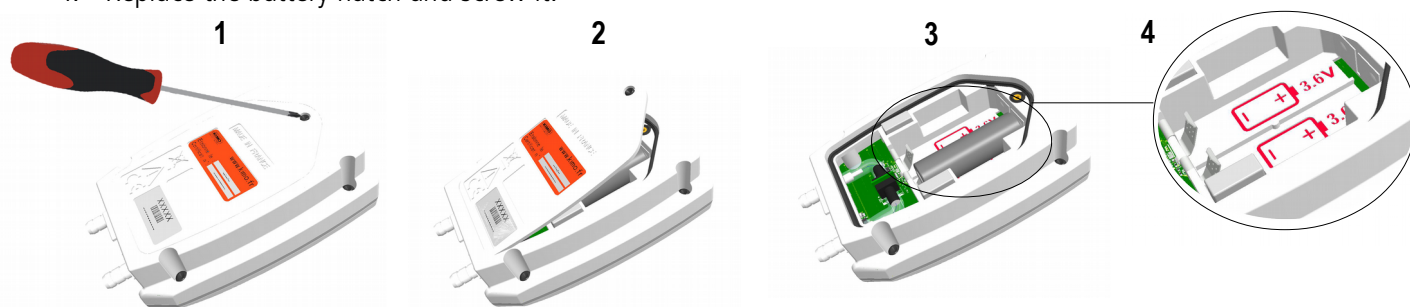

 Only use trademark or high quality batteries in order to guarantee the announced autonomy.

 After the battery replacement, the device must be reconfigured.

6.2 Device cleaning

Please avoid any aggressive solvent.

Please protect the device and probes from any cleaning produce containing formalin, that may be used for cleaning rooms and ducts.

6.3 Safety lock wall mount with padlock

- Mount the safety lock support on the required place.
- 1. Present the KISTOCK datalogger on the support **starting with the inferior part**
- 2. Clip the KISTOCK on the support by falling back the superior part
- 3. Insert the padlock to ensure the safety lock function



- To remove the datalogger from the support, proceed on reverse order.

 The padlock can be replaced by a fail-safe sealed



The datalogger can be placed on the screw-mount without the safety lock function

* On the basis of 1 measurement each 15 minutes at 25°C.

7 Calibration

A calibration certificate is available as option under paper format.
We recommend to carry out a yearly checking.

7.1 KCC 320: perform a CO₂ measurement verification

To avoid potential drifts, it is recommended to perform regularly a CO₂ measurement verification.

- Before checking the CO₂ measurement, verify the atmospheric pressure values measured by the device: launch a dataset, or press the  **"Selection"** button to scroll the measurements.
- If the atmospheric pressure values are not compliant, it is possible to carry out a measurement correction with the **KILOG** software (please see the **KILOG** software user manual, "Measurement correction" chapter).

- Once the atmospheric pressure checked, verify the CO₂ measurement: launch a dataset, or press the  **"Selection"** button to scroll the measurements.
- Connect a bottle of CO₂ standard gas on the gas connection on the back of the **KCC 320** device with the supplied Tygon® tube.
- Generate a gas flow of 30 l/h.
- Wait for the measurement stabilisation (about 2 minutes).
- Check the CO₂ values measured by the **KCC 320**.
- If these values are not compliant, it is possible to carry out a measurement correction with the **KILOG** software (please see the **KILOG** software user manual, "Measurement correction" chapter).



7.2 KP 320 – KP 321: perform an auto-zero



It is possible to reset the device during a recording dataset:

- Unplug the pressure tubes of the device.
- Press the  **"Selection"** button during 5 seconds to carry out the auto-zero.

The instrument resets. The screen displays "..."

- Plug the pressure tubes.
- The device continues the measurements and the dataset recording.*







It is possible to reset the device when values are measured but not recorded:

- Unplug the pressure tubes of the device.
- Press the  **"Selection"** button to display the measurement.
- Press the  **"Selection"** button during 5 seconds to carry out the auto-zero.

The instrument resets. The screen displays "..."

- Plug the pressure tubes.
- The device continues the measurements.*

8 Accessories

Accessories	References	Illustrations
1 double AA lithium 3.6 V battery  2 batteries are required for class 320 dataloggers	KBL-AA	
Safety lock wall mount with padlock	KAV-320	
Wired extension for class 320 KISTOCK probes In polyurethane, 5 m length with male and female mini-DIN connectors <u>Note:</u> several extensions can be wired in order to obtain up to 25 m cable length	KRB-320	
Configuration and data processing software KILOG software allows to configure, save and process your data in a very simple way.	<u>Software only:</u> KILOG-3-N <u>Complete set (software + 1 USB cable):</u> KIC-3-N	
Data collector Collects up to 20 000 000 points from one or several KISTOCK directly on-site. Results restitution on PC of realised datasets	KNT-320	
USB micro-USB cable which allows to plug your KISTOCK datalogger to your PC	CK-50	

 **Only the accessories supplied with the device must be used.**

9 Troubleshooting

Problem	Probable cause and possible solution
No value is displayed, only the icons are present.	The display is configured on "OFF". Configure it on "ON" with the KILOG software (see page 16).
The display is completely off* and there is no communication with the computer.	The battery has to be replaced. (see page 17).
The display indicates "- - - -" instead of the measured value.	The probe is disconnected. Plug it again to the datalogger.
There is no wireless connection with the datalogger.	The wireless connection activation is on OFF. Reconfigure the wireless connection on ON with the KILOG software (see page 16).

* Only with the KT 320 and KTT 320 KISTOCK.