

## USER MANUAL

# CLASS 120 KISTOCK KT 120 – KH 120

# Table of contents

1	SAFETY INSTRUCTIONS.....	4
1.1	Precautions for use.....	4
1.2	Symbols used.....	4
2	PRESENTATION OF THE DEVICE.....	5
2.1	Use.....	5
2.2	Applications.....	5
2.3	Description of the device.....	5
2.4	Description of the keys.....	5
2.5	PC connection.....	5
2.6	Fixation.....	6
3	TECHNICAL FEATURES.....	6
3.1	Devices.....	6
3.2	Housing.....	7
3.3	Dimensions.....	7
3.4	Warranty period.....	7
4	USE OF THE DEVICE.....	8
4.1	Display.....	8
4.2	Functions of keys.....	8
4.2.1	Groups organisation.....	10
4.3	Data logger configuration with the integrated PDF file.....	10
4.4	Data logger download with PDF report edition.....	13
4.5	Configuration, data logger download and data processing with the KILOG software.....	14
5	DEVICE MAINTENANCE.....	15
5.1	Replace the battery.....	15
5.2	Device cleaning.....	15
6	CALIBRATION.....	16
7	ACCESSORIES.....	16
8	TROUBLESHOOTING.....	16

# 1 SAFETY INSTRUCTIONS

## 1.1 Precautions for use

Please always use the device in accordance with its intended use and within parameters described in the technical features in order not to compromise the protection ensured by the device.

## 1.2 Symbols used

For your safety and in order to avoid any damage of the device, please follow the procedure described in this user manual and read carefully the notes preceded by the following symbol:



The following symbol will also be used in this user manual:  
Please read carefully the information notes indicated after this symbol.



## 2 PRESENTATION OF THE DEVICE

### 2.1 Use

The KT 120 and KH 120 data loggers of the HVAC range allow the internal measurement of temperature only (KT 120) or of temperature and humidity (KH 120). This class of devices is dedicated to the food transport.

The devices have a male USB plug and an integrated software in PDF format which enables to download and configure the data logger without specific software.

### 2.2 Applications

The KISTOCK data logger is ideal for a temperature and humidity control for the sensitive foodstuff storage, for example in the food industry or pharmaceutical domain. It allows to control the temperature and humidity in refrigerators, cold rooms, food trucks etc.

Therefore, the device guarantees a traceability all along the cold chain. And at any moment the KISTOCK data logger allows to edit easily and quickly a data report in PDF format.



### 2.3 Description of the device



### 2.4 Description of the keys

 **"OK" key:** allows to validate, start or stop the records, display the value

 **"Selection" key:** allows the functions scroll

### 2.5 PC connection



## 2.6 Fixation

The KT 120 and KH 120 KISTOCK data loggers have a magnetic mounting, so you can fix it easily.

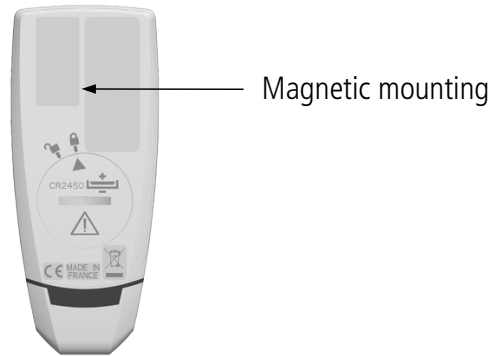

## 3 TECHNICAL FEATURES

### 3.1 Devices

	KT 120	KH 120
Units displayed	°C, °F	°C, °F, %RH
Resolution	0.1°C, 0.1°F	0.1°C, 0.1°F, 0.1%RH
External input	USB connector	
Internal sensor	Temperature	Temperature, humidity
Type of sensor	NTC	<u>Temperature</u> : NTC <u>Humidity</u> : capacitive
Measuring range	From -40 to +70°C	<u>Temperature</u> : From -20 to +70°C <u>Humidity</u> : From 0 to 100%RH
Accuracies*	±0.4°C from -20 to 70°C ±0.8°C below -20°C	<u>Temperature</u> : ±0.4°C from 0 to 50°C ±0.8°C below 0°C or above 50°C  <u>Humidity**</u> : ±2.5%RH (from 5 to 95%RH, 15°C to 25°C)
Setpoint alarms	2 setpoint alarms on each channel	
Number of points	50 000	
Frequency of measurement	From 1 minute to 24 hours	
Working temperature	From -40 to +70°C	From -20 to +70°C
Storage temperature	From -40 to +85°C	
Battery life	3 years***	500 days***
European directives	2011/65/EU RoHS II; 2012/19/EU WEEE; 2014/30/UE EMC; 2014/30/UE	

\* All accuracies indicated in this document were stated in laboratory conditions and can be guaranteed for measurement carried out in the same conditions, or carried out with calibration compensation.

\*\* Factory calibration uncertainty: ±0.88%RH; Temperature dependence: ±0.04 x (T-20) %RH (if T<15°C or T>25°C)

\*\*\* On the basis of 1 measurement each 15 minutes at 25°C

### 3.2 Housing

<b>Dimensions</b>	100 x 42.5 x 15.9 mm
<b>Weight</b>	53 g
<b>Display</b>	1-line LCD screen Dimensions of screen: 32 x 25.5 mm
<b>Control</b>	1 OK key 1 Selection key
<b>Material</b>	Compatible with food industry environment ABS housing
<b>Protection</b>	IP65: KT 120 IP20: KH 120
<b>PC communication</b>	1 USB A male input
<b>Battery power supply</b>	1 x CR2450 (button battery)
<b>Environmental conditions of use</b>	Air and neutral gases Humidity: in non condensing conditions Maximum altitude: 2000 m

### 3.3 Dimensions

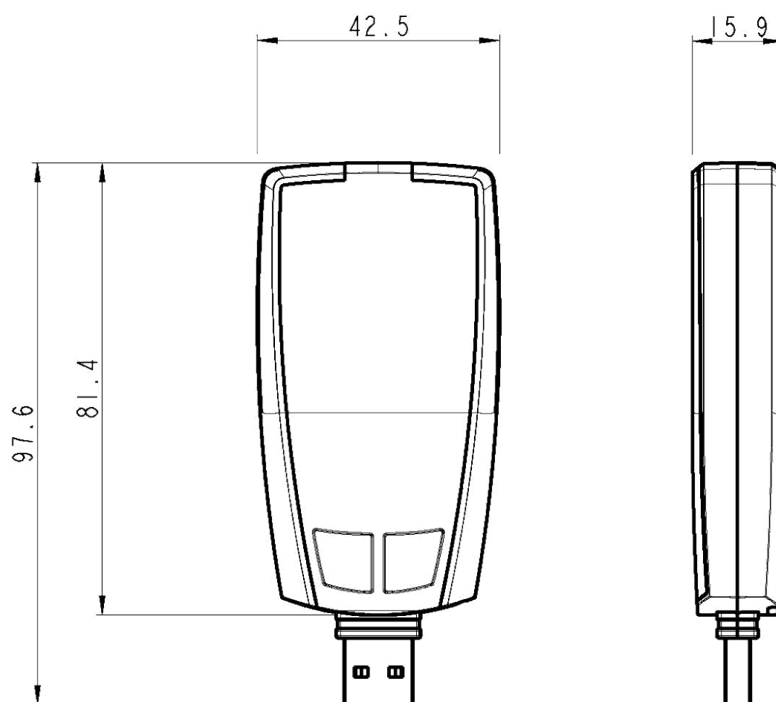

### 3.4 Warranty period

KISTOCK data loggers have 1-year guarantee for any manufacturing defect (return to our After-sales service required).

4.1 Display

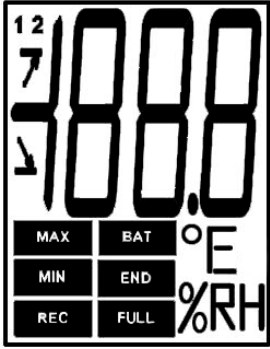

- END** DATASET is finished
- REC** Indicates that one value is being recorded. It flashes: the DATASET did not start already.
- FULL** Flashing slowly: DATASET is between 80 and 90 % of the storage capacity.  
Flashing quickly: DATASET is between 90 and 100 % of the storage capacity.  
Constant: storage capacity full.
- BAT** Constant: indicates that the batteries have to be replaced.
- 12** Indicates the channel number which is measuring.
- MIN** The displayed values are the recorded maximum/minimum values for the displayed channels.
- MAX** The displayed values are the recorded maximum/minimum values for the displayed channels.
- Indicates the alarm action type: rising or falling action.
- °C** Temperature in °C.
- °F** Temperature in °F.
- %RH** Relative humidity (KH 120).

- The values to display selected during configuration via the software will scroll on the screen every 3 seconds (only with the KH 120).
- The display can be activated or deactivated via the KILOG software.
- At extreme temperatures, the display can become hardly readable and its display speed can slow down at temperatures below 0°C. This has no incidence on the measurement accuracy.

4.2 Functions of keys

- OK key:** enables to start, stop the dataset (press during >3 seconds) or to change of scrolling group as described in the tables below.
- Selection key:** enables the scroll values in the scrolling group as described in the tables below.

Device state	Type of start/stop selected	Key used	Action generated	Illustration
flashes	Start: by key	During 3 seconds	Dataset starting	During 3 seconds
	Stop: indifferent		Inactive	
	Start by PC or date/hour		Inactive	
	Stop: indifferent		Inactive	
	Start: indifferent		Measurements scrolling (group 1)*	Or wait 3 seconds
	Stop: indifferent			

\* Please see the summary table of the groups organization on page 10.  
 \*\* Only with the KH 120.

Device state	Type of start/stop selected	Key used	Action generated	Illustration
	Start: indifferent  Stop: by key	 During 3 seconds	Dataset stop	 During 3 seconds
Dataset in progress <b>REC</b>	Start: indifferent  Stop: indifferent		Group change (groups 2 and 3)*	
	Start: indifferent  Stop: indifferent		Groups scrolling (groups 1, 2 and 3)*	
Dataset finished <b>END</b>	Indifferent  Indifferent	  	Inactive  Measurements scrolling*	

\* Please see the summary table of the groups organization on the following page.

\*\* Only with the KH 120.



### 4.2.1 Groups organisation

The table below summarises the groups organisation and measured values available during a measurement dataset.

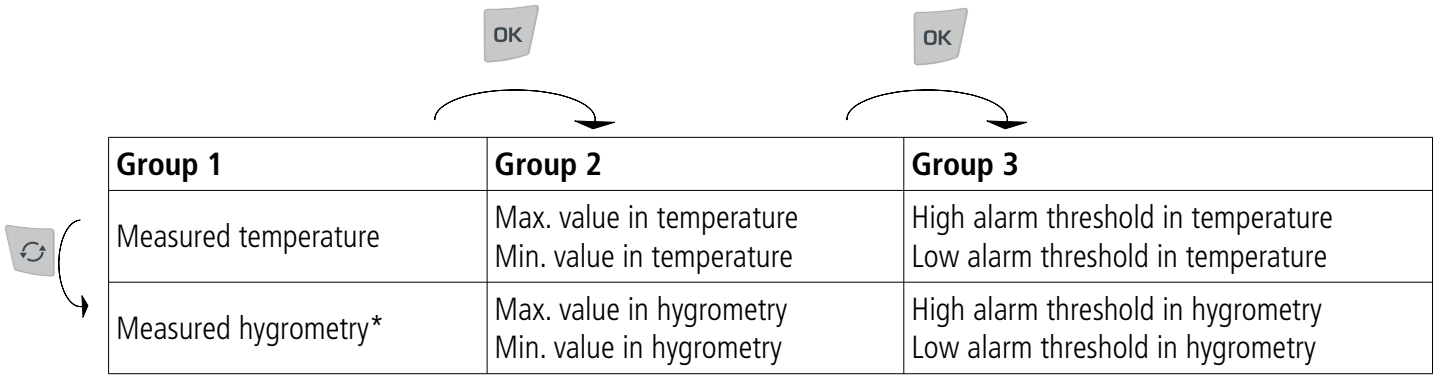

Group 1	Group 2	Group 3
Measured temperature	Max. value in temperature Min. value in temperature	High alarm threshold in temperature Low alarm threshold in temperature
Measured hygrometry*	Max. value in hygrometry Min. value in hygrometry	High alarm threshold in hygrometry Low alarm threshold in hygrometry

Press  key to change of group.

Press  key to scroll the values in the group.

### 4.3 Data logger configuration with the integrated PDF file

The class 120 KISTOCK data loggers have an integrated PDF file which allows to configure quickly and easily the data logger. Therefore, you can directly configure your data logger without opening the KILOG software.

 **Required configuration:** to open this document, you need to use ONLY the “**Adobe Acrobat Reader 9®**” program (or higher), freely downloadable, which allows to read PDF format documents. Ensure you have installed it before starting.

- Plug the class 120 KISTOCK data logger on an USB port of your computer\*\*.
- The following window opens:*

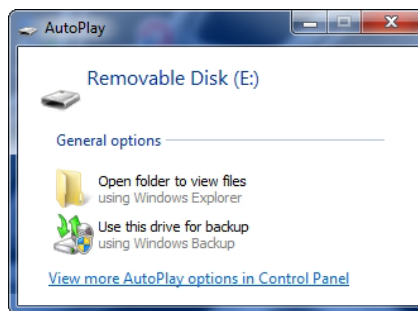

- Click on “**Open folder to view files**”.
- Wait a few seconds (according to the dataset number of points), and a volume appears.*
- Double-click on the “**Configuration...**” PDF file  configuration KT [1K 15.05.99999]

\* Only with the KH 120.

\*\* The computer must be in compliance with the IEC60950 standard.

The integrated configuration file opens:

The file **header** indicates the device name and serial number.

Button which allows to **load a previous configuration**, saved before on the computer.

**"General information"** Displays the name of the dataset and the possible comments.

**"Configuration"** allows to configure:  
 - The datalogger  
 - The recording mode  
 - The stop conditions of the record

**"Channel parameters"** allows to configure the channels of temperature (KT 120 and KH 120) and hygrometry (only with the KH 120).

- **Choose the language**

Select the required language:

Language

English
Deutsch
English
Chinese (simplified)
Español
Français
Italiano

- **Choose the date format**

Select the required date format:

Date format

DD-MM-YYYY hh:mm
DD-MM-YYYY hh:mm
MM-DD-YYYY hh:mm
YYYY-MM-DD hh:mm

- **General information**

Dataset name: this field allows to name the dataset.

Comments: this field allows to write comments on dataset.

**General informations**

Dataset	Dataset name
Comments	Comment 1 Comment 2

- **Configuration**

### Recorder

**Active screen:** tick **"Yes"** to activate the screen display or **"No"** to deactivate it.

**Management DST:** for an automatic management of DST, tick **"Yes"** or tick **"No"** to deactivate it. If you choose **"Yes"**, the **"Next time change"** fields become accessible. Dates and times of the next time change are proposed by default. You can modify them: click on the **"Date"** field then on  to display the calendar. Click on the required date.

Click on the **"Hour"** field to modify the time on which the next time change will be applied: the time format is 00:00. On the last field, click on  and choose **"+1h"** to add an hour or **"-1h"** to subtract an hour. The date and time change will be applied on the required date and time and will add or subtract an hour.



### Configuration

Recorder

Active screen  Yes  No

Management DST  Yes  No

Next time change

Date 01/03/2016 02:00 +1h 

Date 30/10/2016 03:00 -1h 

### Recording



**Interval:** in the **"Interval"** field, inform the required interval duration between two measurements, then select the unit (minutes or hours).

### Start type

- Tick **"Button"** for a start type by button.

- Tick **"Date"** for a start type by date: inform the required date and time of the start. Click on the **"Start date"** field then click on  to display the calendar and select the required date, or write it manually, with respect to the date format selected previously.

Recording

Interval 10  Minutes  Hours

Start Type  Button  Date

Start date 20/10/2015 12:00

### Stop conditions

### Stop type

Select the required stop type:

Stop type

Duration 

Date

Duration

Nbr of items

Total Memory

Loop

- The stop by date is available only if the start type by date has been chosen previously. If you choose **"Date"**, inform the required stop date and time in the **"Stop date"** field: click on  to display the calendar then select the required date, or write it manually with respect to the date format selected previously.

- The stop by duration allows to determine a recording duration: inform the **"Days"** and **"Hours"** fields.

- The stop by number of items allows to determine a required number of measurement before the dataset stops. Inform the **"Number of items"** field (between 1 and 50 000 points).

- **"Total memory"** allows to record continuously up to 50 000 points before the dataset stops.

- **"Loop"** allows to record the values continuously and once the memory capacity reached, the last recorded values overwrite the first.

- **"Stop by button"**: tick **"Yes"** to allow a stop by button. Therefore, push the data logger

**OK** key during 3 seconds to stop the measurement dataset. To not allow it, tick **"No"**. The

stop by button can not be deactivated if the chosen stop condition is **"Loop"**, **"Total memory"** or **"Number of points"**.



Stop conditions

Stop type Duration 

Stop date 18/11/2015 12:00

No. of items 4 321

Duration Days 30 Hours 00:00

Stop by button  Yes  No

### Channel parameters

### Temperature (KT 120 and KH 120) and humidity (only the KH 120)

- Choose the temperature measurement unit: tick the **"°C"** or **"°F"** box.

- Active channel: tick **"Yes"** to activate the channel or **"No"** to deactivate it.

- Active alarm: tick **"Yes"** to activate the alarm or **"No"** to deactivate it.

 Active channel  Yes  No

Active alarm  Yes  No

If the alarm is activated, inform the **"High"** and **"Low"** fields to configure the alarm threshold. Inform the **"Delay"** field in number of points. According to the measurement interval previously configured, the duration is automatically actualised.

For example: if an interval of 1 minute has been configured and that the delay in number of points for the high threshold is 5, the delay duration will be 5 minutes.

- When the configuration is finished, click on the  button to validate.
- Chose the place to save the configuration: to use this configuration for the next dataset, save the configuration directly on the data logger on **"Removable disk"**.

**Channel parameters**

Temperature  °C  °F

 Active channel  Yes  No

 Active alarm  Yes  No



High Low

Alarm threshold

Delay (nb pts)

Delay (Duration)

**Check that the dataset is finished to ensure the new configuration is taken into account.**

- *A message asks you to overwrite the existing file.*
- Click on **"Yes"**.
- To use this configuration later for another dataset, or to configure another device, you can save it on the required location. To recover it later, click on the  button on top of the page, then select the required file on **".xdp"** format, click on the  button to use it for the next dataset.



#### 4.4 Data logger download with PDF report edition

- Plug the class 120 KISTOCK data logger on an USB plug of the computer\*.





*Wait a few seconds, then the following window opens:*

- Click on **"Open folder to view files"**.  
*The windows explorer opens.*
- Double-click on the **"Report"** PDF file to visualise the dataset report.  **REPORT**

\* The computer must be in compliance with the IEC60950 standard.

Example of report:

**State indicators:**

-  : Alarm activated
-  : Alarm deactivated
-  : Alarm OK
-  : Alarm triggered

The **background information** indicates the dataset name and the eventual comments.

The **device configuration** is summarised with the measurement interval, the start/stop type, the recording duration, the number of recorded values and the date and time of dataset start and end.

The **chart** allows to visualise the recorded values evolution, with the units on ordinate, the date and time on abscissa and the defined high and low thresholds.

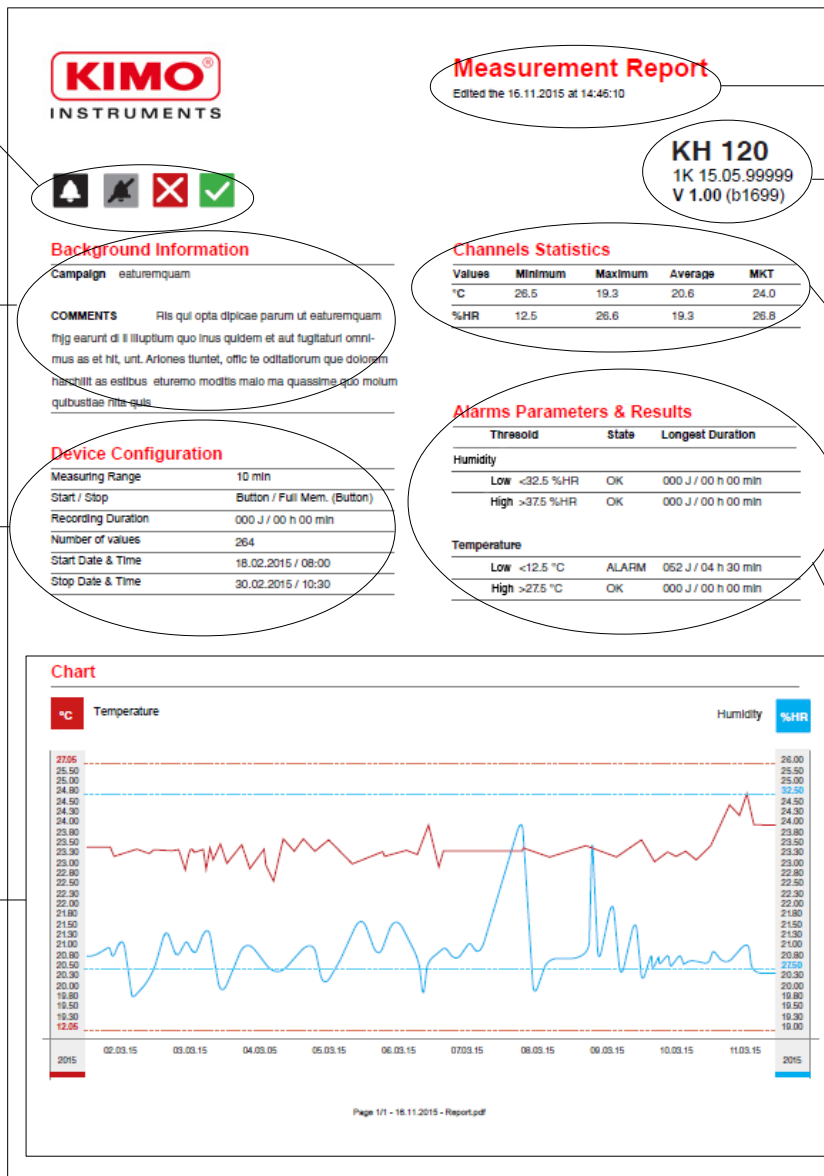

The **header** indicates the date and time of the report edition

**Device references** Serial number and firmware version

The **channel statistics** indicate the values unit and the minimal, maximal, average and MKT values.

The **alarms parameters and results** indicate the defined high and low thresholds, their state (alarm or OK) and the longest duration of threshold exceeding.

➤ You can print it or export it in PDF format to integrate it easily to your documents.

**i** In "Loop" mode, results displayed on "Device configuration", "Channel statistics" and "Alarms parameters and results" parts correspond to the device configuration, to the statistics and to the alarms parameters and results recorded since the launching of the measurement dataset. Data indicated on the graph correspond to the results of the last recorded loop.

## 4.5 Configuration, data logger download and data processing with the KILOG software

Please see the KILOG software user manual: "KILOG-classes-50-120-220-320".

### 5.1 Replace the battery

With 500 days to 3 years\* battery life, KISTOCK guarantees long-term measurement.

#### To replace the battery:

1. Unlock the battery hatch with a screwdriver or a coin.
2. Turn towards the left until the marker aligns in front of the opened padlock symbol.
3. Continue to turn until the hatch rises.
4. Replace the battery (button battery CR 2450\*\*) in such a way the + pole will be visible.

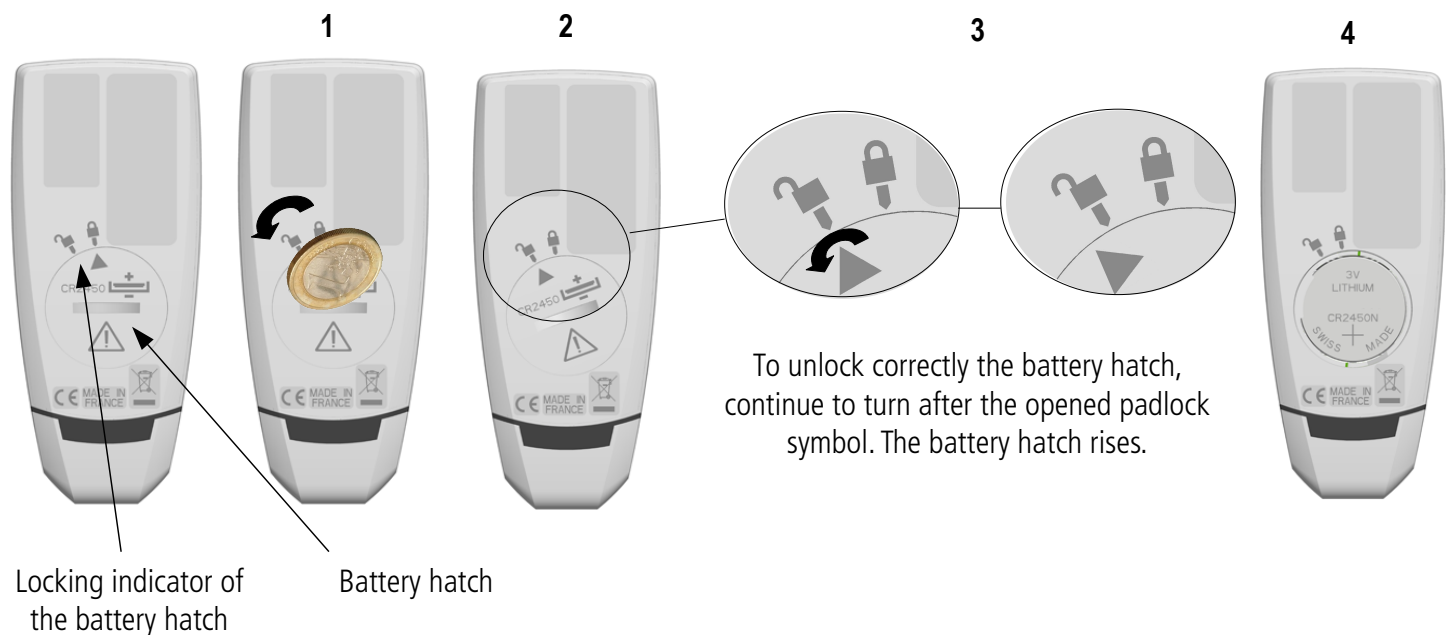

- Replace the battery hatch with the indicator in front of the opened padlock and close it by turning it towards the right in order to make correspond the indicator with the closed padlock.

**i** Only use trademark or high quality batteries in order to guarantee the announced autonomy.

**!** After the battery replacement, the device must be reconfigured.

### 5.2 Device cleaning

Please avoid any aggressive solvent.

Please protect the device from any cleaning produce containing formalin, that may be used for cleaning rooms and ducts.

\* On the basis of 1 measurement each 15 minutes at 25°C

\*\* The battery must be in compliance with the 60086-4 standard.





## 6 CALIBRATION

All the KISTOCK devices have an integrated adjustment certificate in the memory in PDF format which can be visualized and printed easily.

A calibration certificate is available as option in paper format.

We recommend to carry out a yearly checking.

## 7 ACCESSORIES

Accessories	Part numbers	Illustrations
1 button battery CR2450	KBL-2450	
KILOG Lite Free software to download on the Sauermann website <a href="http://sauermanngroup.com">sauermanngroup.com</a> Allows the data download (graphics and points statement) and the data logger configuration.	KILOG-LITE	
KILOG software KILOG software enables to configure, save and process your data in a very simple way.	KILOG-3-N	
Calibration certificate	-	-
25 mm diameter metal washer with double sided adhesive tape	KRM	

 **Only the accessories supplied with the device must be used.**

## 8 TROUBLESHOOTING

Problem	Probable cause and possible solution
"hi" or "lo" is displayed.	The measuring range is exceeded, if the problem persists please proceed to a factory return of the device.
No value is displayed, only the icons are present.	The display is set <b>"OFF"</b> . Set it on <b>"ON"</b> with the KILOG software (see page 14).
The display is completely off and there is no communication with the computer.	The battery must be replaced (see page 15).
"Err." is displayed.	Error during the device update (reading or writing error in the flash memory of the micro-controller). Remove the battery from the device. Carry out a long press on the "Selection" key. Put the battery back. A count is displayed. Press "OK" before the end of the count. The bootloader version is displayed then "---". Connect the device to the computer and launch the update procedure (see the software user manual, chapter "Update the device").
"Er. 1" is displayed.	Temperature measurement error. Please proceed to a factory return of the device.