

SPECIFICATIONS

White light source	Broad spectrum LED, min. 100,000 hours
Sensing distance	28mm
Spot size (dia.)	1mm
Depth of field	+/-3 mm from focal point (approx. 28mm)
Response time	25uS
Switching Frequency	40kHz
LED Intensity	3 levels
Gray-scale	00 to 50
Controls	MARK and BKGD keys
Digital Output	Auto-Detect PNP / NPN
Analog output	0..5V (20mV resolution)
Power indicator	Green LED
Detect indicator	Yellow LED
Programming indicator	Yellow/green LED
Data retention	EEPROM non-volatile memory
Dimensions	2.0"(51mm) x 2.4"(61mm) x 1.0"(25mm)
Weight	0.21 lbs. (95 g)
Supply Voltage	10...24 VDC
Operating Current	60 mA
Short Circuit Protection	Discrete output
Overload / Reverse Polarity Protection	Supply voltage
Operating temperature	-20°C...55°C
Storage temperature	-20°C...70°C
Housing	Plastic
Mechanical protection	IP65
Connector	M12, 4-pin

CAUTIONS AND WARNINGS

CAUTION: The discrete output must not be connected to outputs from other sensors (i.e. outputs from multiple sensors must not be connected in parallel). Parallel connections may damage sensor output circuitry.

CAUTION: Sensor is not suitable for wash down or hazardous environments; a separate enclosure with the appropriate ratings is recommended for these applications.

IMPORTANT:
This product is an accessory or part of a system. Always read and follow the manufacturer's instructions for the equipment before connecting this product. Comply with all applicable codes and safety regulations. Failure to do so may result in damage, injury or death.



CNTX-35-TP

CONTRAST SENSOR



OPERATING INSTRUCTIONS

MATERIALS SUPPLIED

- Operating Instructions
- CNTX-35-TP sensor
- Bracket 130-10140362

GENERAL DESCRIPTION

The CNTX-35-TP sensor combines small spot size and fast response to achieve high-speed contrast detection capable of detecting a wide variety of marks and objects. The CNTX effectively detects contrast differences between many colors on various surfaces over a range of 50 grayscale levels. The modulated white light source in the CNTX is focused to a 2.5 to 3mm spot and directed toward a target. The diffused light returning to the sensor is measured. When the level is equal to or exceeds the threshold the discrete output changes state. Due to the fast response of the sensor, it is suitable for use in high-speed applications. The sensor provides a discrete output that automatically configures to NPN and PNP. A PLC or a computer can be used to monitor the status of the discrete output signal.

TEACH-IN

Two keys are provided, MARK and BKGD, which are used to set the sensor's detection level. The sensor output will activate when the MARK is detected. The mark may be lighter or darker than the background.

To set the sensor:

1. Place the MARK or BKGD in the sensor's light spot and press the appropriate key. Flashing yellow LED indicates proceed with MARK setting, flashing green LED indicates proceed with BKGD setting.
2. Place the other, MARK or BKGD in the sensor's light spot and press the appropriate key. Flashing yellow /green LED indicates insufficient contrast error. Repeat from step 1.
3. Verify that the Yellow led indicates the presence of the mark.

TARGETS WITH MULTIPLE COLORS

MARK is lighter than the background:

Program the MARK (for example, white), then the next brightest, closest gray scale color that is printed as the background (for example, yellow). The threshold would be set between the white and the yellow color, therefore should only trigger when the white is present.

MARK is darker than the background:

Program the MARK on the dark mark (for example, black) and program the BKGD using the next closest gray scale color (for example, brown) as the background and the threshold will be set between these two colors.

INSTALLATION

Install the sensor using accessory bracket 130-10140362 or suitable alternative bracket. Position the sensor at approximately 28mm from the target object (measured from the sensor lens surface). Normally the sensor may be positioned on a 15-20° angle to prevent interference from glossy surfaces. When using the sensor to detect the glossy characteristic of the target, position the sensor perpendicular to the target. Connect the cable, UVX300-C, to power and outputs as required. Do not use other cable without verifying connections and wire colors or damage to the sensor may occur.

CONTROLS

Output LED

During normal operation the yellow LED indicates MARK and the green LED indicates BACKGROUND. Yellow/green LED indicates MARK or BKGD readings are being taken.

MARK key

Sets mark level. After MARK is measured the LED may flash green indicating that BACKGROUND measurement is required.

BKGD key

Sets background level. After BACKGROUND is measured the LED may flash yellow indicating that MARK measurement is required.

OUTPUT SIGNALS

Discrete output

The discrete output is a PNP/NPN configuration allowing the user to provide a load on this output that is either pulled high to VDC or low to ground. The sensor monitors this level and automatically determines whether to operate the PNP/NPN driver. This output is typically connected to a PLC. The output remains active as long as the mark is recognized as indicated by the yellow LED on the sensor.

CAUTION: The discrete output must not be connected to outputs from other sensors (i.e. outputs from multiple sensors must not be connected in parallel). Parallel connections may damage sensor output circuitry.

Analog Output

The analog output is 0-5V with 20mV resolution (8-bit). Any standard analog input channel typically available on a PLC may monitor this output. The analog output signal is useful in applications where simply triggering on the threshold is

insufficient. For example, constant real-time monitoring of intensity in process allows minor fluctuations or trends to be detected permitting corrective action to be taken. The analog output response time is slower than the discrete output response time and should be evaluated per the requirements of each application.

M12 CONNECTIONS

M12 Connector	Wire Color	Description
Pin 1	Brown	Power 10 to 24VDC
Pin 2	White	Analog output
Pin 3	Blue	Ground
Pin 4	Black	Discrete output, PNP/NPN

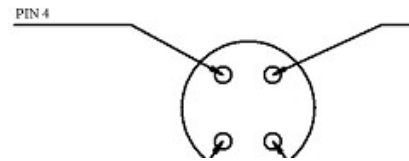

DIMENSIONAL DETAILS

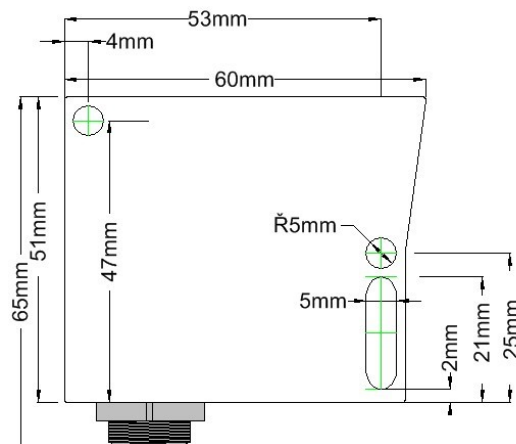

WARRANTY

EMX Industries Incorporated warrants all products to be free of defects in materials and workmanship for a period of two years under normal use and service from the date of sale to our customer. This warranty does not cover normal wear and tear, abuse, misuse, overloading, altered products, damage caused by incorrect connections, lightning damage, or use other than intended design.

There is no warranty of merchantability. There are no warranties expressed or implied or any affirmation of fact or representation except as set forth herein.

EMX Industries Inc. sole responsibility and liability, and the purchaser's exclusive remedy shall be limited to the repair or replacement at EMX Industries option of a part or parts found not conforming to the warranty. In no event shall EMX Industries Inc. be liable for damages of any nature, including incidental or consequential damages, including but not limited to damages resulting from non-conformity, defect in material or workmanship.



effective date January 1, 2002