

Ausführung		Buchse, Ø 8 mm, gerade	Buchse, Ø 8 mm, abgewinkelt	Buchse, Ø 8 mm, abgewinkelt mit LEDs PNP	Buchse, Ø 8 mm, abgewinkelt mit LEDs NPN
Anzahl Kontakte		3			
Bestelldaten					
Kabel aus PUR (s. Seite 8)	L = 2 m	XZ CP0166L2	XZ CP0266L2	XZ CP0366L2	XZ CP0466L2
	L = 5 m	XZ CP0166L5	XZ CP0266L5	XZ CP0366L5	XZ CP0466L5
	L = 10 m	XZ CP0166L10	XZ CP0266L10	XZ CP0366L10	XZ CP0466L10
Gewicht (kg)		0,050 (L = 2 m), 0,110 (L = 5 m), 0,215 (L = 10 m)			

Technische Daten					
Zulassungen		UL		UL	
Schutzart		Steckanschluss (1)		Steckanschluss (1)	
Schutzart		IP 67 (bei korrekter Steckverbindung)		IP 65 (bei korrekter Steckverbindung)	
Umgebungstemperatur	Statisch	- 35...+ 90 °C		- 35...+ 90 °C	
	Dynamisch	- 5...+ 90 °C		- 5...+ 90 °C	
Anschluss		Leitungsdurchmesser 5,2 mm, Leiterquerschnitt: 3 x 0,34 mm ²		Leitungsdurchmesser 5,2 mm, Leiterquerschnitt: 3 x 0,34 mm ²	
Funktionsanzeige mit LED		-		2 LEDs PNP	2 LEDs NPN
Bemessungsspannung		~ 60 V, --- 75 V		--- 10...30 V	
Bemessungsstrom		4 A		4 A	
Isolationswiderstand		> 10 ⁹ Ω		> 10 ⁹ Ω	
Widerstand der Kontakte		≤ 5 mΩ		≤ 5 mΩ	

Abmessungen		
XZ CP0166L●	XZ CP0266L●	XZ CP0366L●, XZ CP0466L●

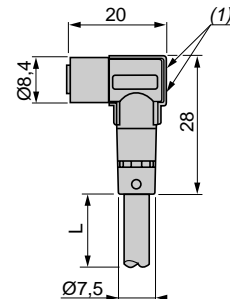
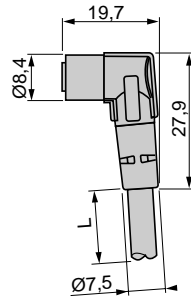
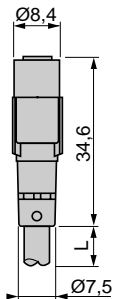

(1) 2 LEDs begrenzt auf --- 10...30 V max.
L = 2, 5 oder 10 m

Anschlüsse

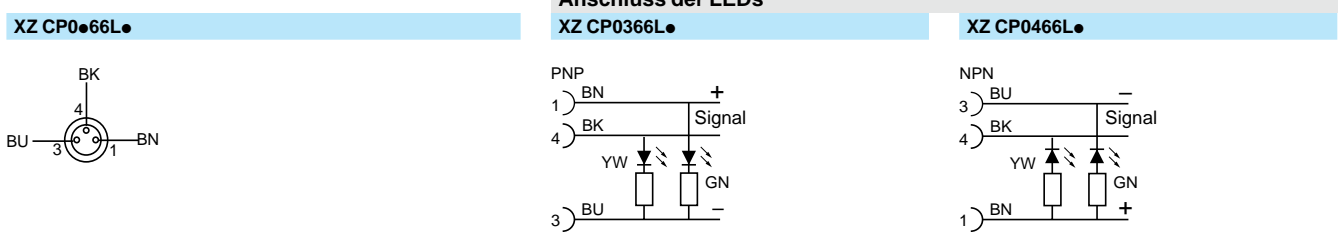

(1) Steckanschluss ohne Verrastung.

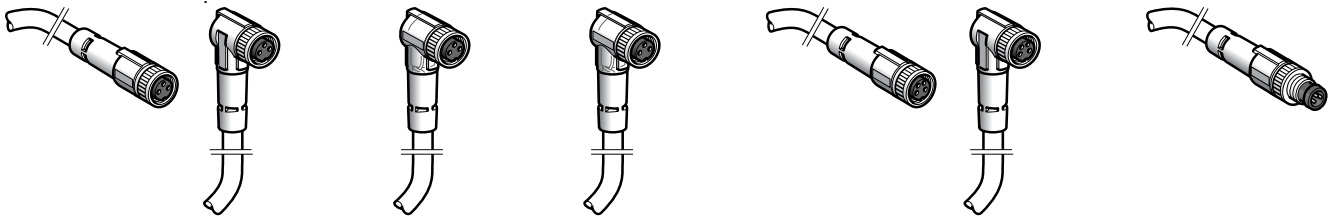

Buchse, M8, gerade	Buchse, M8, abgewinkelt	Buchse, M8, abgewinkelt mit LEDs PNP	Buchse, M8, abgewinkelt mit LEDs NPN	Buchse, M8, gerade	Buchse, M8, abgewinkelt	Stecker, M8, gerade
3				4		3

XZ CP0566L2	XZ CP0666L2	XZ CP0766L2	XZ CP0866L2	XZ CP0941L2	XZ CP1041L2	XZ CP2737L05
XZ CP0566L5	XZ CP0666L5	XZ CP0766L5	XZ CP0866L5	XZ CP0941L5	XZ CP1041L5	XZ CP2737L1
XZ CP0566L10	XZ CP0666L10	XZ CP0766L10	XZ CP0866L10	XZ CP0941L10	XZ CP1041L10	XZ CP2737L2
0,060 (L = 2 m), 0,120 (L = 5 m), 0,225 (L = 10 m)				0,080 (L = 2 m), 0,180 (L = 5 m), 0,360 (L = 10 m)		0,030 (L = 0,5 m), 0,050 (L = 1 m), 0,080 (L = 2 m)

UL	UL	UL	UL
Schraubanschluss (Metall-Spannring)	Schraubanschluss (Metall-Spannring)	Schraubanschluss (Metall-Spannring)	Schraub-/Steckanschl. (Metall-Spannring)
IP 67 (bei korrektem Schraubanschluss)	IP 67 (bei korrektem Schraubanschluss)	IP 67 (bei korrektem Schraubanschluss)	IP 67 (bei korrektem Schraubanschluss)
-35...+90 °C	-35...+90 °C	-35...+90 °C	-35...+90 °C
-5...+90 °C	-5...+90 °C	-5...+90 °C	-5...+90 °C
Leitungsdurchmesser 5,2 mm, Leiterquerschnitt: 3 x 0,34 mm ²	Leitungsdurchmesser 5,2 mm, Leiterquerschnitt: 3 x 0,34 mm ²	Leitungsdurchmesser 5,2 mm, Leiterquerschnitt: 4 x 0,34 mm ²	Leitung Ø 5,2 mm, Leiterquerschnitt: 3 x 0,34 mm ²
-	2 LEDs PNP	2 LEDs NPN	-
~ 60 V, ≐ 75 V	≐ 10...30 V	~ 60 V, ≐ 75 V	~ 60 V, ≐ 75 V
4 A	4 A	4 A	4 A
> 10 ⁹ Ω	> 10 ⁹ Ω	> 10 ⁹ Ω	> 10 ⁹ Ω
≤ 5 mΩ	≤ 5 mΩ	≤ 5 mΩ	≤ 5 mΩ

XZ CP0566L●	XZ CP0666L●	XZ CP0766L●, XZ CP0866L●	XZ CP0941L●	XZ CP1041L●	XZ CP2737L●
--------------------	--------------------	---------------------------------	--------------------	--------------------	--------------------

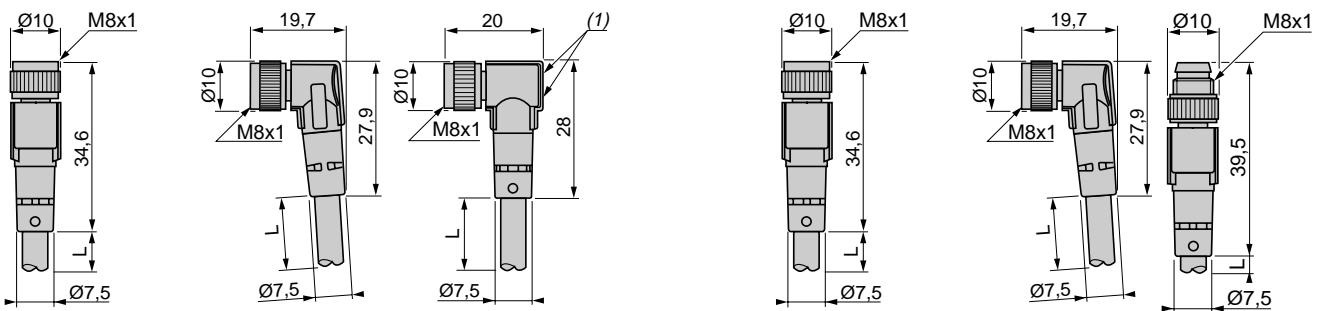

(1) 2 LEDs begrenzt auf ≐ 10...30 V max.

L = 2, 5 oder 10 m

L = 0,5, 1 oder 2 m

Anschluß der LEDs

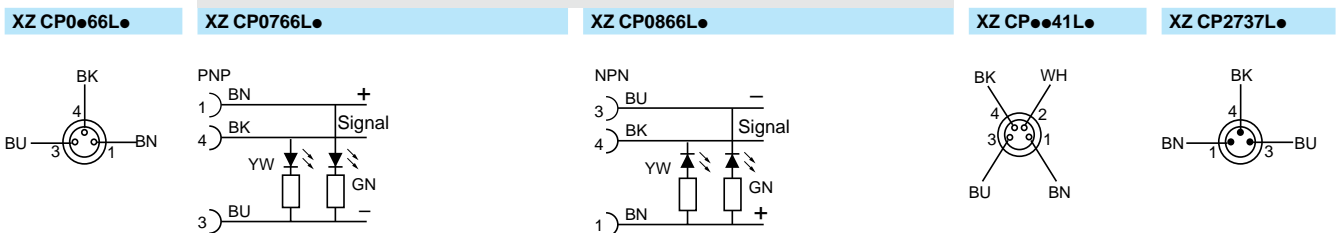

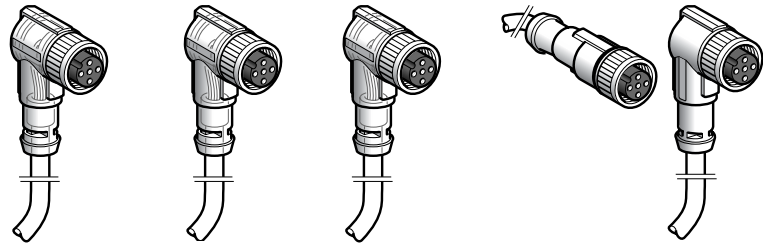

Ausführung	Buchse, M12, abgewinkelt mit LEDs	Buchse, M12, abgewinkelt mit LEDs	Buchse, M12, abgewinkelt mit LEDs	Buchse, M12, gerade	Buchse, M12, abgewinkelt	
Anzahl Kontakte	3			4		
Bestelldaten						
Kabel aus PUR (s. Seite 8/7)	L = 0,5 m	-				
	L = 1 m	-				
	L = 2 m	XZ CP2540L2	XZ CP1340L2	XZ CP1440L2	XZ CP1141L2	XZ CP1241L2
	L = 5 m	XZ CP2540L5	XZ CP1340L5	XZ CP1440L5	XZ CP1141L5	XZ CP1241L5
	L = 10 m	XZ CP2540L10	XZ CP1340L10	XZ CP1440L10	XZ CP1141L10	XZ CP1241L10
Gewicht (kg)	0,080 (L = 2 m), 0,180 (L = 5 m), 0,350 (L = 10 m)			0,090 (L = 2 m), 0,190 (L = 5 m), 0,370 (L = 10 m)		

Technische Daten					
Zulassungen	UL			UL	
Anschlussart	Schraubanschluss (Edelstahl-Spannung)		Schraubanschluss (Metall-Spannung)		Schraubanschluss (Metall-Spannung)
Schutzart	IP 67 (bei korrektem Schraubanschluss)			IP 67 (bei korrektem Schraubanschluss)	
Umgebungstemperatur	Statisch	- 35...+ 90 °C		- 35...+ 90 °C	
	Dynamisch	- 5...+ 90 °C		- 5...+ 90 °C	
Anschluss	Leitungsdurchmesser 5,2 mm, Leiterquerschnitt: 3 x 0,34 mm ²			Leitungsdurchmesser 5,2 mm, Leiterquerschnitt: 4 x 0,34 mm ²	
Funktionsanzeige mit LED	2 LEDs PNP	2 LEDs PNP	2 LEDs NPN	-	
Bemessungsspannung	~ 10...30 V			~ 250 V, ~ 300 V	
Bemessungsstrom	4 A			4 A	
Isolationswiderstand	> 10 ⁹ Ω			> 10 ⁹ Ω	
Widerstand der Kontakte	≤ 5 mΩ			≤ 5 mΩ	

Abmessungen
XZ CP2540L, XZ CP1340L, XZ CP1440L XZ CP1141L XZ CP1241L

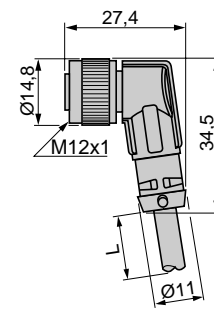
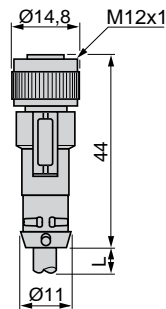
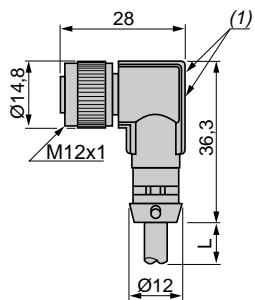

(1) 2 LEDs begrenzt auf ~ 10...30 V max.
L = 2, 5 oder 10 m

Anschlüsse

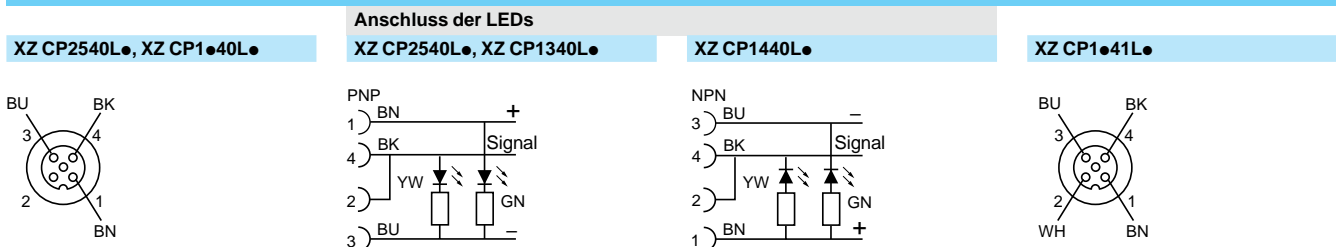

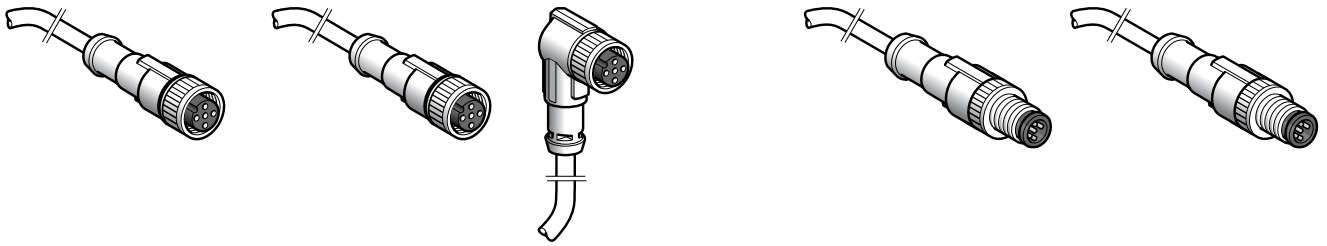

Buchse, M12, gerade	Buchse, M12, gerade	Buchse, M12, abgewinkelt	Stecker, M12, gerade	Stecker, M12, gerade
4	5	5	4	5
-			XZ CP1541L05	XZ CP1564L05
-			XZ CP1541L1	XZ CP1564L1
XZ CP1169L2	XZ CP1164L2	XZ CP1264L2	XZ CP1541L2	XZ CP1564L2
XZ CP1169L5	XZ CP1164L5	XZ CP1264L5	-	
XZ CP1169L10	XZ CP1164L10	XZ CP1264L10	-	
0,105 (L = 2 m), 0,260 (L = 5 m), 0,500 (L = 10 m)	0,115 (L = 2 m), 0,270 (L = 5 m), 0,520 (L = 10 m)		0,030 (L = 0,5 m), 0,050 (L = 1 m), 0,085 (L = 2 m)	0,040 (L = 0,5 m), 0,065 (L = 1 m), 0,115 (L = 2 m)
UL		UL		
Schraubanschluss (Metall-Spannring)		Schraubanschluss (Metall-Spannring)		
IP 67 (bei korrektem Schraubanschluss)		IP 67 (bei korrektem Schraubanschluss)		
- 35...+ 90 °C		- 35...+ 90 °C		
- 5...+ 90 °C		- 5...+ 90 °C		
Leitungsdurchmesser 5,7 mm, Leiterquerschnitt: 4 x 0,34 mm ²	Leitungsdurchmesser 5,9 mm, Leiterquerschnitt: 5 x 0,34 mm ²	Leitungsdurchmesser 5,2 mm, Leiterquerschnitt: 4 x 0,34 mm ²	Leitungsdurchmesser 5,9 mm, Leiterquerschnitt: 4 x 0,34 mm ² + 1 x 0,5 mm ²	
-	-	-	-	
~ 250 V, ≍ 300 V	~ 30 V, ≍ 36 V	~ 250 V, ≍ 300 V	~ 30 V, ≍ 36 V	
4 A	4 A	4 A	4 A	
> 10 ⁹ Ω	> 10 ⁹ Ω	> 10 ⁹ Ω	> 10 ⁹ Ω	
≤ 5 mΩ	≤ 5 mΩ	≤ 5 mΩ	≤ 5 mΩ	

XZ CP1169L, XZ CP1164L

XZ CP1264L

XZ CP1541L, XZ CP1564L

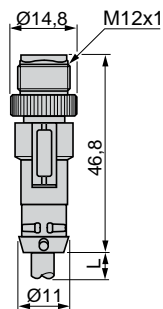
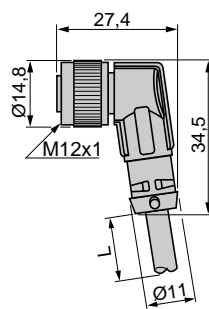
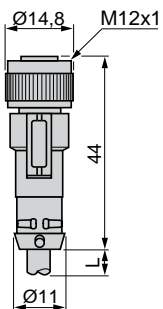

L = 2, 5 oder 10 m

L = 0,5, 1 oder 2 m

XZ CP1169L

XZ CP164L

XZ CP1541L

XZ CP1564L

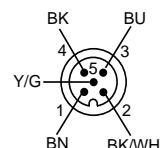
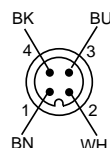
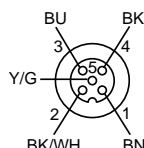
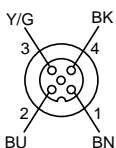

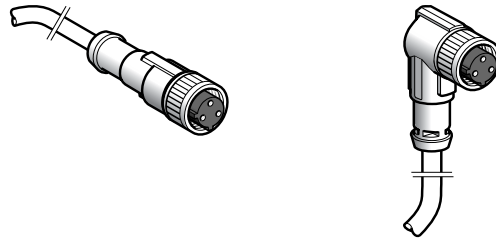

Ausführung	Buchse, 1/2" 20UNF, gerade	Buchse, 1/2" 20UNF, abgewinkelt
Anzahl Kontakte	3	

Bestelldaten

Kabel aus PUR (s. Seite 8/7)	L = 2 m	XZ CP1865L2	XZ CP1965L2
	L = 5 m	XZ CP1865L5	XZ CP1965L5
	L = 10 m	XZ CP1865L10	XZ CP1965L10
Gewicht (kg)	0,080 (L = 2 m), 0,180 (L = 5 m), 0,350 (L = 10 m)		

Technische Daten

Zulassungen	UL
Anschlussart	Schraubanschluss (Metall-Spannring)
Schutzart	IP 67 (bei korrektem Schraubanschluss)
Umgebungstemperatur	- 35...+ 80 °C
Anschluss	Leitungsdurchmesser 5,2 mm, Leiterquerschnitt: 3 x 0,34 mm ²
Funktionsanzeige mit LED	-
Bemessungsspannung	~ 250 V, --- 300 V
Bemessungsstrom	4 A
Isolationswiderstand	> 10 ⁹ Ω
Widerstand der Kontakte	≤ 5 mΩ

Abmessungen

XZ CP1865L●

XZ CP1965L●

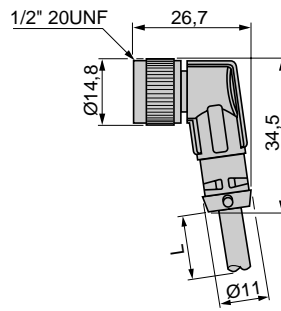
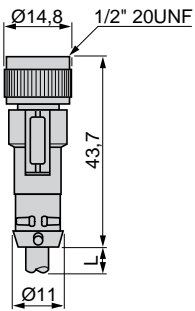

L = 2, 5 oder 10 m

Anschlüsse

XZ CP1●65L●

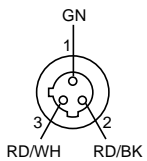

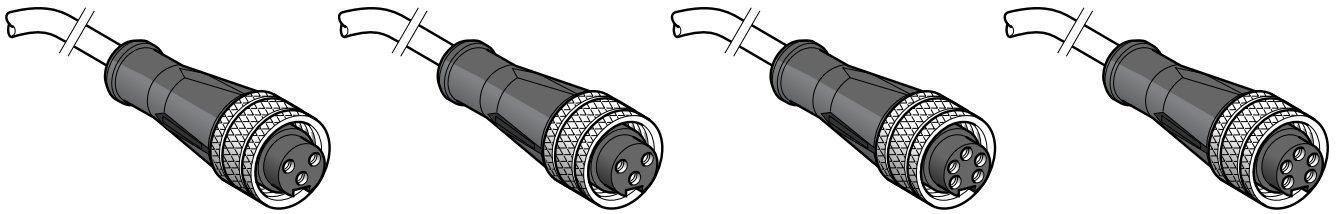

Buchse, 7/8" 16UN, gerade 3	Buchse, 7/8" 16UN, gerade	Buchse, 7/8" 16UN, gerade 5	Buchse, 7/8" 16UN, gerade
XZ CP1662L2	XZ CP1670L2	XZ CP1764L2	XZ CP1771L2
XZ CP1662L5	XZ CP1670L5	XZ CP1764L5	XZ CP1771L5
–	XZ CP1670L10	XZ CP1764L10	XZ CP1771L10
0,180 (L = 2 m), 0,420 (L = 5 m)	0,180 (L = 2 m), 0,420 (L = 5 m), 0,820 (L = 10 m)	0,185 (L = 2 m), 0,460 (L = 5 m), 0,900 (L = 10 m)	0,190 (L = 2 m), 0,475 (L = 5 m), 0,950 (L = 10 m)
UL	UL	UL	UL
Schraubanschluss (Metall-Spannring)	Schraubanschluss (Metall-Spannring)	Schraubanschluss (Metall-Spannring)	Schraubanschluss (Metall-Spannring)
IP 67 (bei korrektem Schraubanschluss)	IP 67 (bei korrektem Schraubanschluss)	IP 67 (bei korrektem Schraubanschluss)	IP 67 (bei korrektem Schraubanschluss)
- 35...+ 80 °C	- 35...+ 80 °C	- 35...+ 80 °C	- 35...+ 80 °C
Leitungsdurchmesser 5 mm Leiterquerschnitt: 3 x 0,5 mm ²	Leitungsdurchmesser 5 mm Leiterquerschnitt: 3 x 0,5 mm ²	Leitungsdurchmesser 5,9 mm Leiterquerschnitt: 5 x 0,34 mm ²	Leitungsdurchmesser 6,7 mm Leiterquerschnitt: 5 x 0,5 mm ²
–	–	–	–
~ 250 V	~ 250 V	~ 250 V	~ 250 V
6 A	6 A	4 A	6 A
> 10 ⁹ Ω	> 10 ⁹ Ω	> 10 ⁹ Ω	> 10 ⁹ Ω
≤ 5 mΩ	≤ 5 mΩ	≤ 5 mΩ	≤ 5 mΩ

XZ CP1662L●, XZ CP1670L●, XZ CP1764L●, XZ CP1771L●

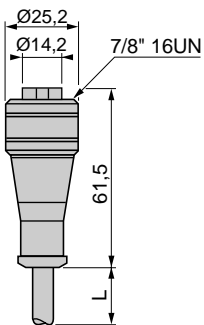

L = 2, 5 oder 10 m

XZ CP1662L●

XZ CP1670L●

XZ CP1764L●

XZ CP1771L●

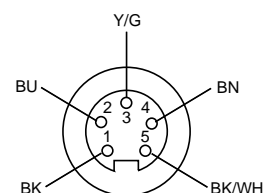
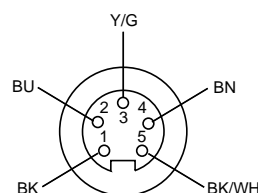
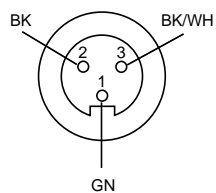
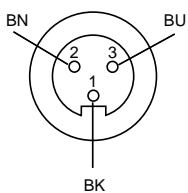

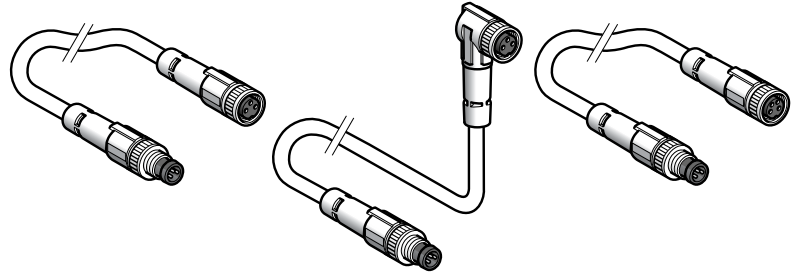

Stecker-Ausführung	M8, 3-polig, gerade		
Buchsen-Ausführung	M8, 3-polig, gerade	M8, 3-polig, abgewinkelt	M8, 4-polig, gerade
Anzahl Leiter	3	3	3

Bestelldaten

Kabel aus PUR	L = 1 m	XZ CR2705037R1	XZ CR2706037R1	XZ CR2709037S1
	L = 2 m	XZ CR2705037R2	XZ CR2706037R2	XZ CR2709037S2
Gewicht (kg)	L = 1 m	0,060		
	L = 2 m	0,090		

Technische Daten

Zulassungen	UL		
Anschlussart	Stecker: Schraub- und Steckanschluss. Buchse: Schraubanschluss. Metallring.		
Schutzart	IP 67		
Umgebungstemperatur	Statisch	- 35...+ 90 °C	
	Dynamisch	- 5...+ 90 °C	
Leiterquerschnitt	3 x 0,34 mm ²		
Leitungsdurchmesser	5,2 mm		
Bemessungsspannung	~ 60 V, ~ 45 V		
Bemessungsstrom	4 A		
Isolationswiderstand	> 10 ⁹ Ω		
Widerstand der Kontakte	≤ 5 mΩ		

Abmessungen

XZ CR2705037R●	XZ CR2706037R●	XZ CR2709037S●
----------------	----------------	----------------

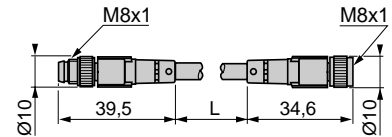
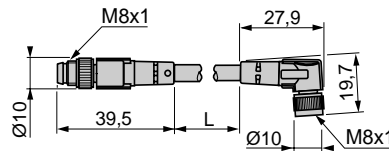
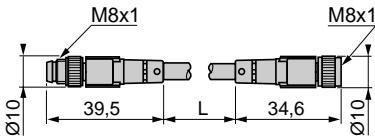

L = 1 oder 2 m

Anschlüsse

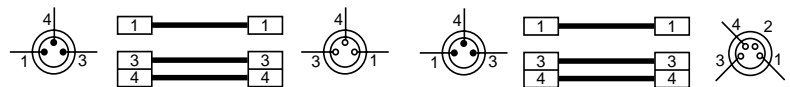
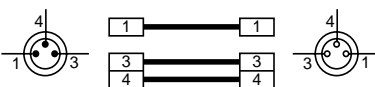

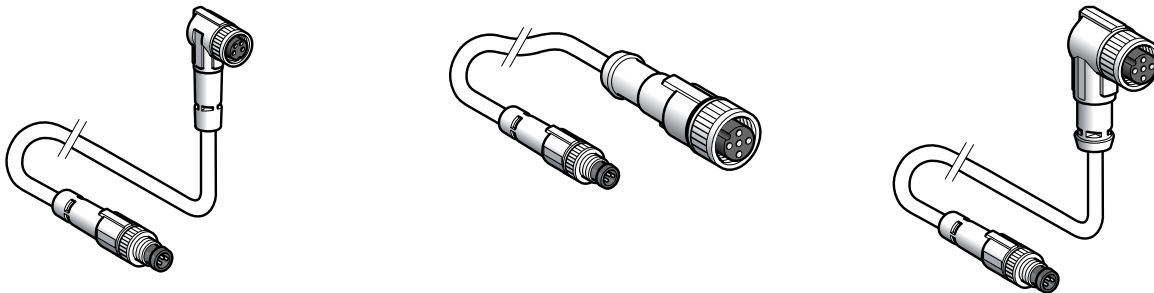

M8, 3-polig, gerade		
M8, 4-polig, abgewinkelt	M12, 5-polig, gerade	M12, 5-polig, abgewinkelt
3	3	3
XZ CR2710037S1	XZ CR2711037T1	XZ CR2712037T1
XZ CR2710037S2	XZ CR2711037T2	XZ CR2712037T2
0,060	0,065	0,065
0,090	0,093	0,093

UL
Stecker: Schraub- und Steckanschluss. Buchse: Schraubanschluss. Metallring
IP 67
-35...+90 °C
-5...+90 °C
3 x 0,34 mm ²
5,2 mm
~ 60 V, ~ 45 V
4 A
> 10 ⁹ Ω
≤ 5 mΩ

XZ CR2710037S●	XZ CR2711037T●	XZ CR2712037T●
-----------------------	-----------------------	-----------------------

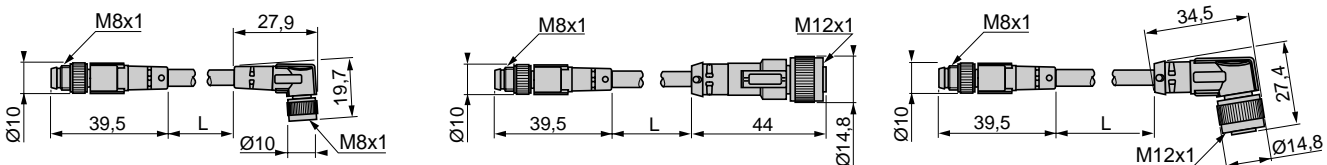

L = 1 oder 2 m

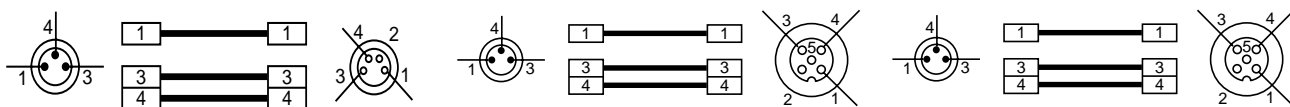

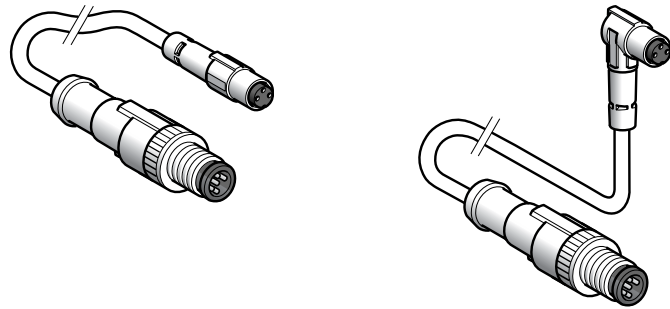

	Steckverbindung	
Stecker-Ausführung	M12, 3-polig, gerade	
Buchsen-Ausführung	Ø 8 mm, 3-polig, gerade	Ø 8 mm, 3-polig, abgewinkelt
Anzahl Leiter	3	

Bestelldaten			
Kabel aus PUR (s. Seite 8)	L = 1 m	XZ CR1501040G1	XZ CR1502040G1
	L = 2 m	XZ CR1501040G2	XZ CR1502040G2
Gewicht (kg)	0,050 (L = 1 m), 0,080 (L = 2 m)		

Technische Daten			
Zulassungen	UL		
Anschlussart	Stecker: Schraubanschluss. Buchse: Steckanschluss (1)		
Schutzart	IP 67 (bei korrekten Steck- und Schraubverbindungen)		
Umgebungs-temperaturen	Statisch	- 35...+ 90 °C	
	Dynamisch	- 5...+ 90 °C	
Leiterquerschnitt	3 x 0,34 mm ²		
Leitungsdurchmesser	5,2 mm		
Bemessungsspannung	~ 60 V, --- 75 V		
Bemessungsstrom	4 A		
Isolationswiderstand	> 10 ⁹ Ω		
Widerstand der Kontakte	≤ 5 mΩ		

Abmessungen	
XZ CR1501040G●	XZ CR1502040G●

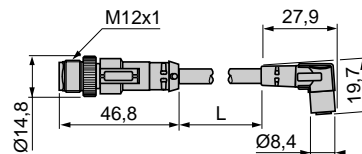
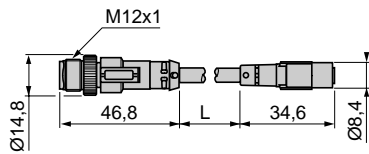

L = 1 oder 2 m

Anschlüsse	
XZ CR1501040G●, XZ CR1502040G●	

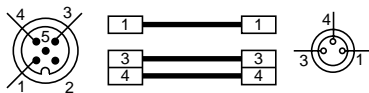

(1) Steckverbindung ohne Verrastung.

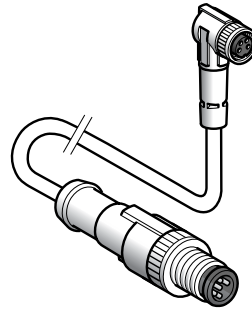
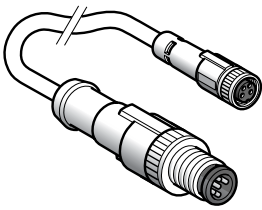

Schraubanschluss

M12, 3-polig, gerade	M8, 3-polig, abgewinkelt	M12, 4-polig, gerade	M8, 4-polig, abgewinkelt
3		4	

XZ CR1509040H1	XZ CR1510040H1	XZ CR1509041J1	XZ CR1510041J1
XZ CR1509040H2	XZ CR1510040H2	XZ CR1509041J2	XZ CR1510041J2
0,050 (L = 1 m), 0,080 (L = 2 m)		0,055 (L = 1 m), 0,090 (L = 2 m)	

UL

Stecker und Buchse: Schraubanschluss

IP 67 (bei korrektem Schraubanschluss)

- 35...+ 90 °C

- 5...+ 90 °C

3 x 0,34 mm²

4 x 0,34 mm²

5,2 mm

~ 60 V, --- 75 V

4 A

> 10⁹ Ω

≤ 5 mΩ

XZ CR1509040H●, XZ CR1509041J●

XZ CR1510040H●, XZ CR1510041J●

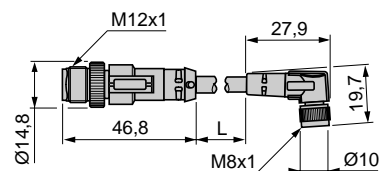
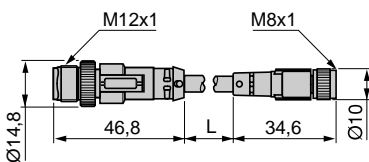

L = 1 oder 2 m

XZ CR1509040H●, XZ CR1510040H●

XZ CR1509041J●, XZ CR1510041J●

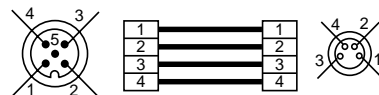
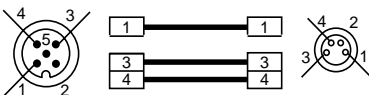

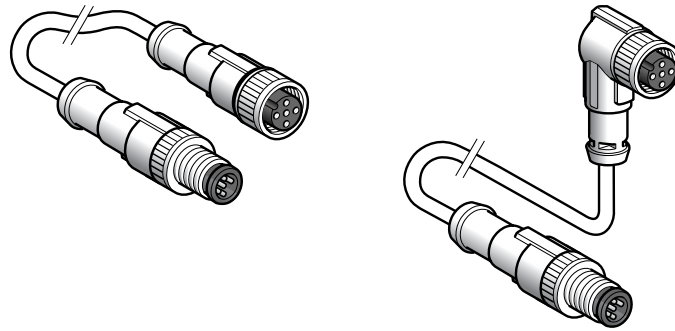

Stecker-Ausführung	M12, 3-polig, gerade				
Buchsen-Ausführung	M12, 3-polig, gerade	M12, 3-polig, abgewinkelt	M12, 3-polig, gerade	M12, 3-polig, abgewinkelt	
Anzahl Leiter	3				
Bestelldaten					
Kabel aus PUR (s. Seite 8/7)	L = 1 m	XZ CR1511040A1	XZ CR1512040A1	XZ CR1511040E1	XZ CR1512040E1
	L = 2 m	XZ CR1511040A2	XZ CR1512040A2	XZ CR1511040E2	XZ CR1512040E2
Gewicht (kg)	0,065 (L = 1 m), 0,095 (L = 2 m)				

Technische Daten		
Zulassungen	UL	
Anschlussart	Stecker und Buchse: Schraubanschluss	
Schutzart	IP 67 (bei korrektem Schraubanschluss)	
Umgebungstemperatur	Statisch	- 35...+ 90 °C
	Dynamisch	- 5...+ 90 °C
Leiterquerschnitt	3 x 0,34 mm ²	
Leitungsdurchmesser	5,2 mm	
Bemessungsspannung	~ 250 V, --- 300 V	
Bemessungsstrom	4 A	
Isolationswiderstand	> 10 ⁹ Ω	
Widerstand der Kontakte	≤ 5 mΩ	

Abmessungen

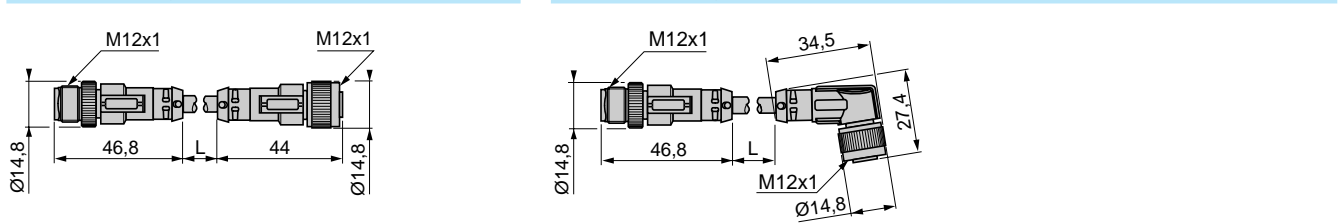

L = 1 oder 2 m

Anschlüsse

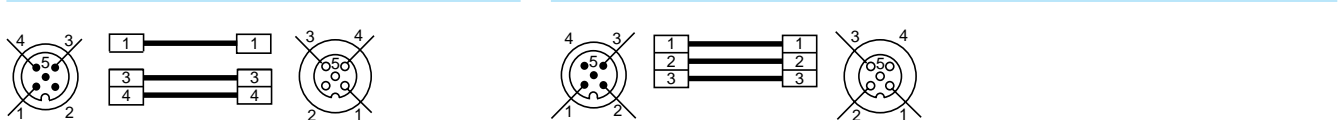

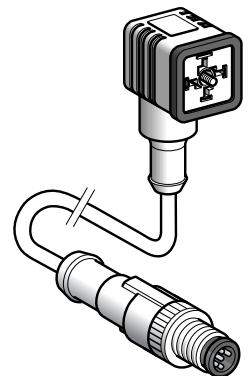
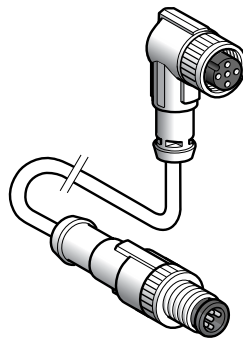
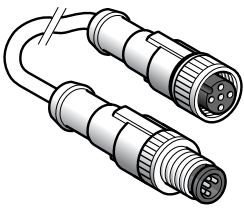

M12, 3-polig, gerade	M12, 3-polig, abgewinkelt	M12, 3-polig, gerade	M12, 3-polig, abgewinkelt	DIN 43650 A, abgewinkelt
M12, 3-polig, gerade				
3				

XZ CR1511062B1	XZ CR1512062B1	XZ CR1511062F1	XZ CR1512062F1	XZ CR1523062K1
XZ CR1511062B2	XZ CR1512062B2	XZ CR1511062F2	XZ CR1512062F2	XZ CR1523062K2
0,065 (L = 1 m), 0,095 (L = 2 m)				0,110 (L = 1 m), 0,140 (L = 2 m)

UL	-
Stecker und Buchse: Schraubanschluss	
IP 67 (bei korrektem Schraubanschluss)	
- 35...+ 90 °C	
- 5...+ 90 °C	
3 x 0,5 mm ²	3 x 0,50 mm ²
5,2 mm	4,5 mm
~ 30 V, ~ 36 V	
4 A	
> 10 ⁹ Ω	
≤ 5 mΩ	

XZ CR1511062B●, XZ CR1511062F●	XZ CR1512062B●, XZ CR1512062F●	XZ CR1523062K●
---------------------------------------	---------------------------------------	-----------------------

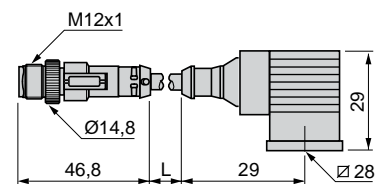
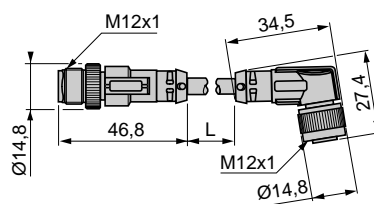
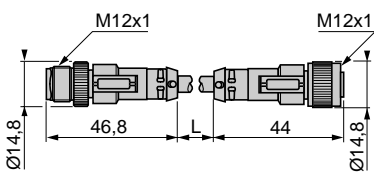

L = 1 oder 2 m

XZ CR1511062B●, XZ CR1512062B●	XZ CR1511062F●, XZ CR1512062F●	XZ CR1523062K●
---------------------------------------	---------------------------------------	-----------------------

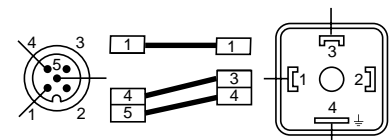
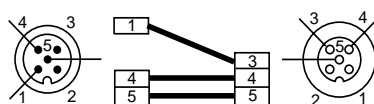
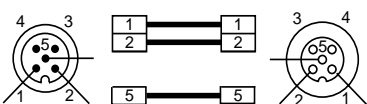

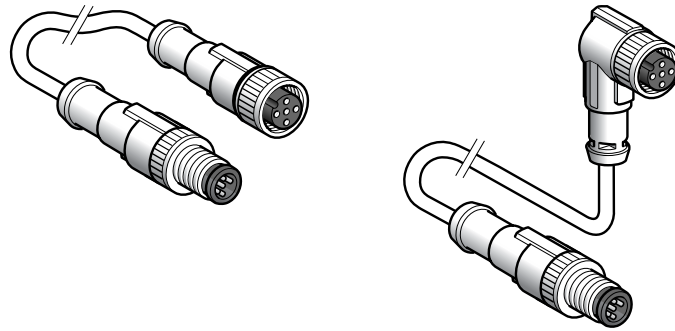

Stecker-Ausführung	M12, 4-polig, gerade	
Buchsen-Ausführung	M12, 4-polig, gerade	M12, 4-polig, abgewinkelt
Anzahl Leiter	4	

Bestelldaten

Kabel aus PUR (s. Seite 8/7)	L = 1 m	XZ CR1511041C1	XZ CR1512041C1
	L = 2 m	XZ CR1511041C2	XZ CR1512041C2
Gewicht (kg)	0,065 (L = 1 m), 0,095 (L = 2 m)		

Technische Daten

Zulassungen	UL	
Anschlussart	Buchse und Stecker: Schraubanschluss	
Schutzart	IP 67 (bei korrektem Schraubanschluss)	
Umgebungstemperatur	Statisch	- 35...+ 90 °C
	Dynamisch	- 5...+ 90 °C
Leiterquerschnitt	4 x 0,34 mm ²	
Leitungsdurchmesser	5,2 mm	
Bemessungsspannung	~ 250 V, ~ 300 V	
Bemessungsstrom	4 A	
Isolationswiderstand	> 10 ⁹ Ω	
Widerstand der Kontakte	≤ 5 mΩ	

Abmessungen

XZ CR1511041C●

XZ CR1512041C●

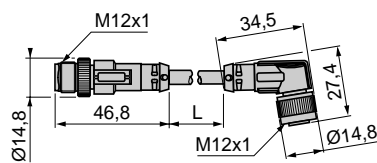
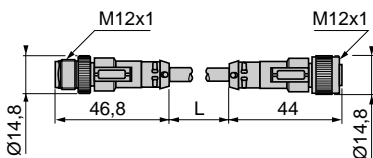

L = 1 oder 2 m

Anschlüsse

XZ CR1511041C●, XZ CR1512041C●

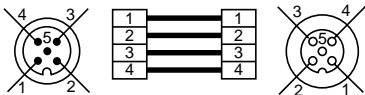

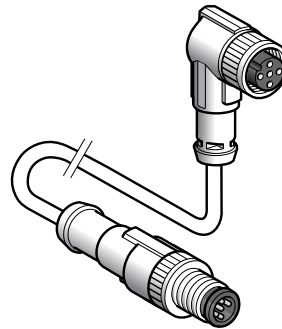
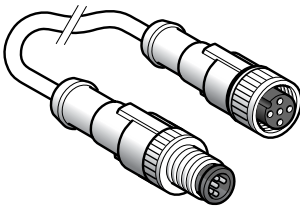

M12, 5-polig, gerade

M12, 5-polig, gerade

5

M12, 5-polig, abgewinkelt

XZ CR1511064D1

XZ CR1511064D2

0,080 (L = 1 m), 0,130 (L = 2 m)

XZ CR1512064D1

XZ CR1512064D2

UL

Buchse und Stecker: Schraubanschluss

IP 67 (bei korrektem Schraubanschluss)

- 35...+ 90 °C

- 5...+ 90 °C

4 x 0,34 mm² + 1 x 0,5 mm²

5,9 mm

~ 30 V, ~ 36 V

4 A

> 10⁹ Ω

≤ 5 mΩ

XZ CR1511064D●

XZ CR1512064D●

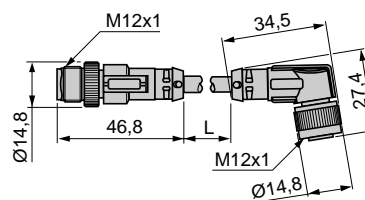
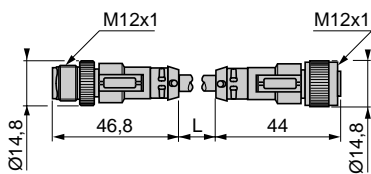

L = 1 oder 2 m

XZ CR1511064D●, XZ CR1512064D●

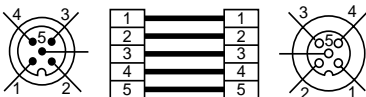

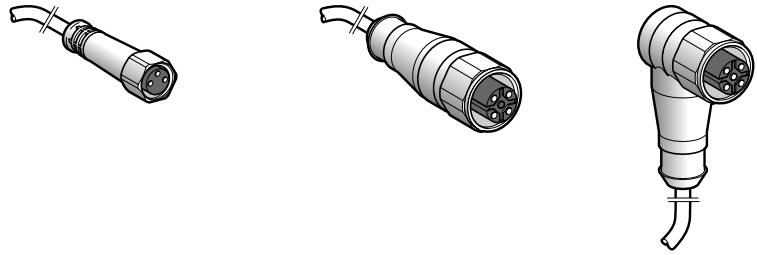

Ausführung	Buchse, M8, gerade	Buchse, M8, gerade	Buchse, M12, gerade	Buchse, M12, abgewinkelt	Buchse, M12, abgewinkelt
Anzahl Kontakte	3	4	4	4	5

Bestelldaten

Kabel aus PVC (s. Seite 8/7)	L = 2 m	–	–	XZ CPA1141L2	XZ CPA1241L2	XZ CPA1164L2
	L = 5 m	XZ CPA0566L5	XZ CPA0941L5	XZ CPA1141L5	XZ CPA1241L5	XZ CPA1164L5
	L = 10 m	XZ CPA0566L10	XZ CPA0941L10	XZ CPA1141L10	XZ CPA1241L10	XZ CPA1164L10
Gewicht (kg)	L = 2 m	–	–	0,090	0,090	0,110
	L = 5 m	0,175	0,200	0,210	0,210	0,250
	L = 10 m	0,340	0,400	0,410	0,410	0,485

Technische Daten

Anschlussart	Schraubanschluss (glatter sechseckiger Spanning aus Edelstahl 316L) (1)				
Abmessung Spanning	9 mm		14 mm		
Schutzart	IP 68		IP 69 K		
Umgebungstemperatur	Statisch - 25...+ 85 °C				
Anschluss	Leitung	Ø 5,0 mm	Ø 5,3 mm	Ø 5,3 mm	Ø 5,3 mm
	Leiterquerschnitt	3 x 0,34 mm ²	4 x 0,34 mm ²	4 x 0,34 mm ²	5 x 0,34 mm ²
Bemessungsspannung	~ 60 V, --- 75 V		~ 250 V, --- 300 V		
Bemessungsstrom	4 A		4 A		
Isolationswiderstand	> 10 ⁹ Ω		> 10 ⁹ Ω		
Widerstand der Kontakte	≤ 5 mΩ		≤ 5 mΩ		

(1) Verschrauben von Hand empfohlen.

Abmessungen

XZ CPA0566L●, XZ CPA0941L●

XZ CPA1141L●

XZ CPA1241L●, XZ CPA1164L●

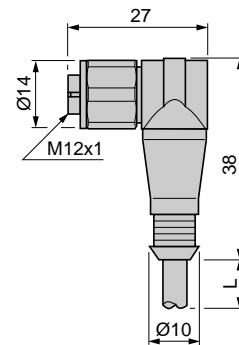
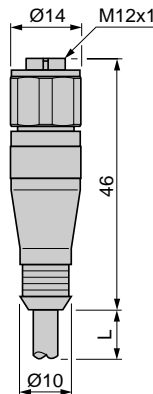
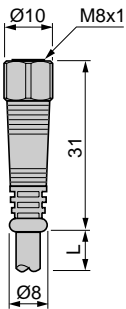

L = 2, 5 oder 10 m

Anschlüsse

XZ CPA0566L●

XZ CPA0941L●

XZ CPA1141L●, XZ CPA1241L●

XZ CPA1164L●

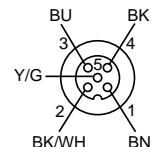
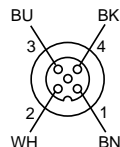
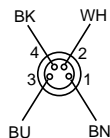
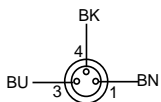

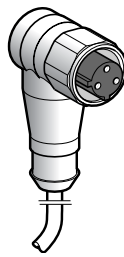
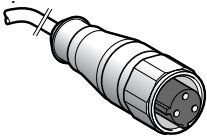

Buchse, 1/2" 20UNF, gerade	Buchse, 1/2" 20UNF, abgewinkelt
3	3
-	-
XZ CPA1865L5	XZ CPA1965L5
XZ CPA1865L10	XZ CPA1965L10
-	-
0,210	0,250
0,410	0,485

Schraubanschluss (glatter sechseckiger Spanning aus Edelstahl 316L) (1)

14 mm	
IP 69K	
- 25...+ 85 °C	
Ø 5,0 mm	
3 x 0,34 mm ²	3 x 0,34 mm ²
~ 250 V, --- 300 V	~ 250 V, --- 300 V
4 A	4 A
> 10 ⁹ Ω	> 10 ⁹ Ω
≤ 5 mΩ	≤ 5 mΩ

(1) Verschrauben von Hand empfohlen.

XZ CPA1865L●

XZ CPA1965L●

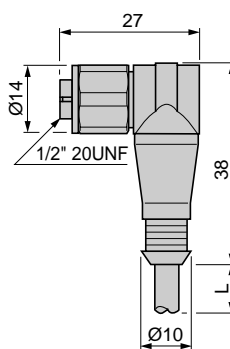
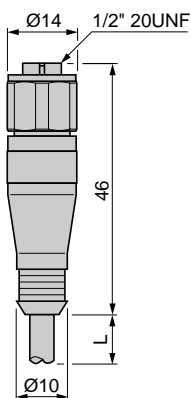

L = 5 oder 10 m

XZ CPA1865L●, XZ CPA1965L●

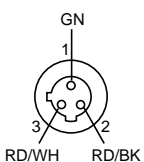



Stecker-Ausführung	M12, 4-polig, gerade	M12, 3-polig, gerade
Buchsen-Ausführung	M8, 4-polig, gerade	M12, 3-polig, gerade
Anzahl Kontakte	4	3

Bestelldaten

Kabel aus PVC (s. Seite 8/7)	L = 2 m	XZ CRA150941J2	XZ CRA151140A2
	L = 5 m	XZ CRA150941J5	XZ CRA151140A5
Gewicht (kg)	L = 2 m	0,100	0,095
	L = 5 m	0,210	0,200

Technische Daten

Anschlussart	Schraubanschluss (glatter sechseckiger Spanning aus Edelstahl 316L) (1)	
Abmessung Spanning	14/9 mm	14 mm
Schutzart	IP 68	IP 69K
Umgebungstemperatur	Statisch	- 25...+ 85 °C
Anschluss	Leitung	Ø 5,3 mm
	Leiterquerschnitt	4 x 0,34 mm ²
Bemessungsspannung	~ 60 V, --- 75 V	~ 250 V, --- 300 V
Bemessungsstrom	4 A	
Isolationswiderstand	> 10 ⁹ Ω	
Widerstand der Kontakte	≤ 5 mΩ	

(1) Verschrauben von Hand empfohlen.

Abmessungen

XZ CRA150941J●

XZ CRA151140A●

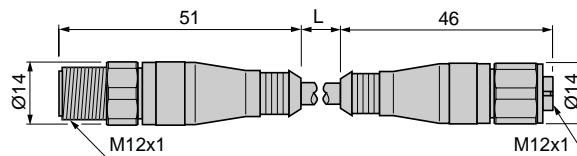
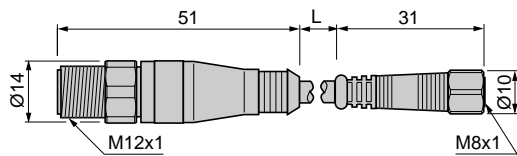

L = 2 oder 5 m

Anschlüsse

XZ CRA150941J●

XZ CRA151140A●

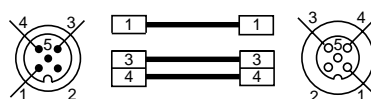
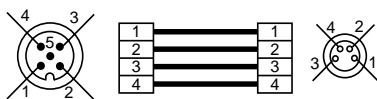

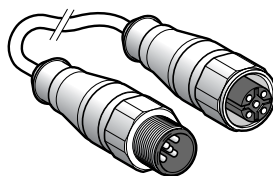
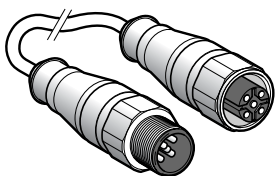

M12, 4-polig, gerade	M12, 5-polig, gerade
M12, 4-polig, gerade	M12, 5-polig, gerade
4	5
XZ CRA151141C2	XZ CRA151164D2
XZ CRA151141C5	XZ CRA151164D5
0,105	0,120
0,220	0,260
Schraubanschluss (glatter sechseckiger Spanning aus Edelstahl 316L) (1)	
14 mm	
IP 69K	
- 25...+ 85 °C	
Ø 5,3 mm	Ø 5,7 mm
4 x 0,34 mm ²	5 x 0,34 mm ²
~ 250 V, ~ 300 V	
4 A	
> 10 ⁹ Ω	
≤ 5 mΩ	

(1) Verschrauben von Hand empfohlen.

XZ CRA151141C●

XZ CRA151164D●

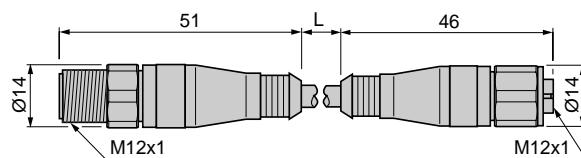
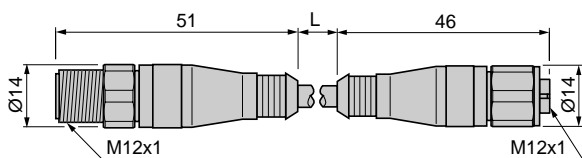

L = 2 oder 5 m

XZ CRA151141C●

XZ CRA151164D●

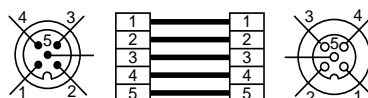
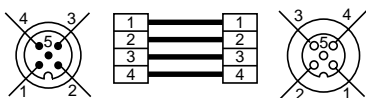

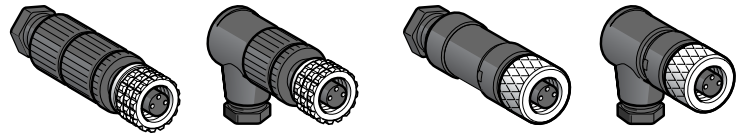

Ausführung	Buchse, M8, gerade	Buchse, M8, abgewinkelt	Buchse, M8, gerade	Buchse, M8, abgewinkelt	
Anzahl Kontakte	3				
Anschlussstyp	Durchdringungstechnik		Lötstifte		
Bestelldaten					
Kunststoff-Gehäuse	Metall-Spannring	XZ CC8FDM30V	XZ CC8FCM30V	XZ CC8FDM30S	XZ CC8FCM30S
	Kunststoff-Spannring	-			
Gewicht (kg)	0,010				
Technische Daten					
Anschlussart	Schraubanschluss (Metall-Spannring)		Schraubanschluss (Metall-Spannring)		
Schutzart	IP 67 (bei korrektem Schraubanschluss)		IP 67 (bei korrektem Schraubanschluss)		
Umgebungstemperatur	- 25...+ 70 °C		- 40...+ 85 °C		
Anschluss	Durchdringungstechnik. Leiterquerschnitt: 0,14...0,34 mm ² Kabelverschraubung M9,5 x 1. Max. Leitung Ø: 5 mm Aderisolation Ø: 1...1,55 mm		Lötstifte. Max. Leiterquerschnitt: 0,25 mm ² Kabelverschraubung M9,5 x 1. Leitung Ø: 5 mm		
Funktionsanzeige mit LED	-		-		
Bemessungsspannung	~ 60 V, --- 75 V		~ 60 V, --- 75 V		
Bemessungsstrom	4 A		4 A		
Isolationswiderstand	> 10 ⁹ Ω		> 10 ⁹ Ω		
Widerstand der Kontakte	≤ 10 mΩ		≤ 5 mΩ		

Abmessungen

XZ CC8FDM30V

XZ CC8FCM30V

XZ CC8FDM30S

XZ CC8FCM30S

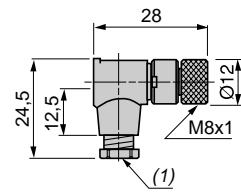
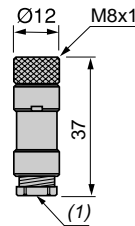
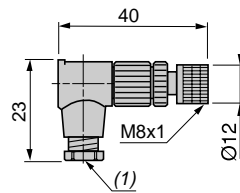
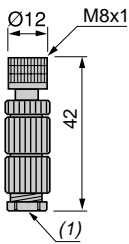

(1) Kabelverschraubung M9,5 x 1

Anschlüsse

XZ CC8FDM30●, XZ CC8FCM30●



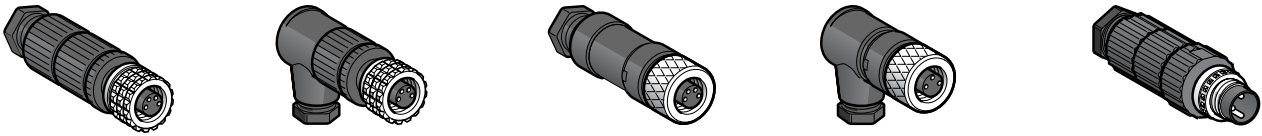

Buchse, M8, gerade	Buchse, M8, abgewinkelt	Buchse, M8, gerade	Buchse, M8, abgewinkelt	Stecker, M8, gerade
4				3
Durchdringungstechnik		Lötstifte		Durchdringungstechnik
XZ CC8FDM40V	XZ CC8FCM40V	XZ CC8FDM40S	XZ CC8FCM40S	XZ CC8MDM30V
-				
0,010				
Schraubanschluss (Metall-Spannring)		Schraubanschluss (Metall-Spannring)		Schraubanschluss (Metall-Spannring)
IP 67 (bei korrektem Schraubanschluss)		IP 67 (bei korrektem Schraubanschluss)		IP 67 (bei korrektem Schraubanschluss)
- 25...+ 70 °C		- 40...+ 85 °C		- 40...+ 85 °C
Durchdringungstechnik. Leiterquerschnitt: 0,14...0,34 mm ² Kabelverschraubung M9,5 x 1. Max. Leitung Ø: 5 mm Aderisolation Ø: 1...1,55 mm		Lötstifte. Max. Leiterquerschnitt: 0,25 mm ² Kabelverschraubung M9,5 x 1. Max. Leitung Ø: 5 mm		Durchdringungstechnik. Leiterquerschnitt: 0,14...0,34 mm ² Kabelverschraubung M9,5 x 1. Max. Leitung Ø: 5 mm Aderisolation Ø: 1...1,55 mm
-		-		-
~ 60 V, ≐ 75 V		~ 60 V, ≐ 75 V		~ 60 V, ≐ 75 V
4 A		4 A		4 A
> 10 ⁹ Ω		> 10 ⁹ Ω		> 10 ⁹ Ω
≤ 10 mΩ		≤ 5 mΩ		≤ 5 mΩ

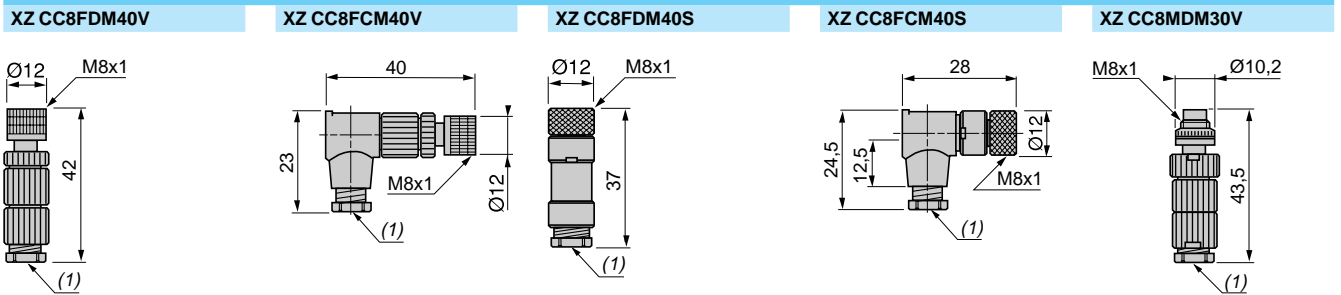

(1) Kabelverschraubung M9,5 x 1

XZ CC8FDM40●, XZ CC8FCM40●	XZ CC8MDM30V
-----------------------------------	---------------------



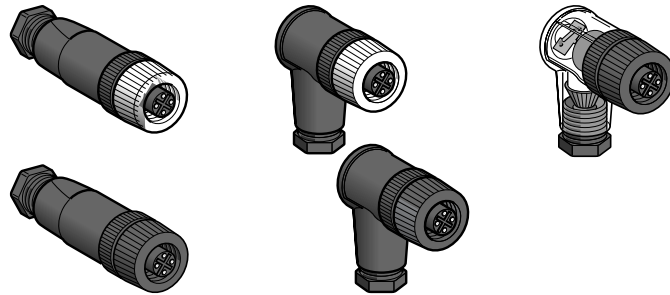

Ausführung	Buchse, M12, gerade	Buchse, M12, abgewinkelt	Buchse, M12, abgewinkelt
Anzahl Kontakte	4		
Anschlussstyp	Schraubklemmen		

Bestelldaten

Kunststoff-Gehäuse	Metall-Spannung	XZ CC12FDM40B	XZ CC12FCM40B	–
	Kunststoff-Spannung	XZ CC12FDP40B	XZ CC12FCP40B	XZ CC12FCP42B
Gewicht (kg)	0,020			

Technische Daten

Anschlussart	Schraubanschluss (Kunststoff- oder Metall-Spannung je nach Ausführung)		
Schutzart	IP 67 (bei korrektem Schraubanschluss)		
Umgebungstemperatur	- 40...+ 85 °C		
Anschluss	Schraubklemmen. Max. Leiterquerschnitt: 0,75 mm ² . Kabelverschraubung Pg 7. Leitungsdurchmesser: 3...6 mm		
Funktionsanzeige mit LED	–	2 LEDs PNP	
Bemessungsspannung	~ 125 V, --- 150 V	--- 10...30 V	
Bemessungsstrom	3 A	3 A	
Isolationswiderstand	> 10 ¹² Ω	> 10 ¹² Ω	
Widerstand der Kontakte	≤ 8 mΩ	≤ 8 mΩ	

Abmessungen

XZ CC12FD●40B

XZ CC12FC●40B, XZ CC12FCP42B

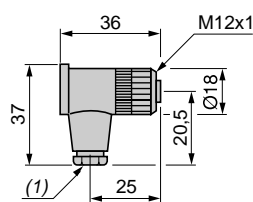
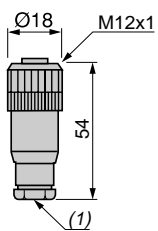

(1) Kabelverschraubung Pg 7

Anschlüsse

XZ CC12FD●40B, XZ CC12FC●40B, XZ CC12FCP42B

Anschluss der LEDs XZ CC12FCP42B

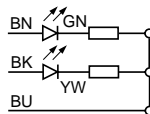



Buchse, M12, gerade, geschirmt	Buchse, M12, gerade	Buchse, M12, abgewinkelt	Buchse, 1/2" 20UNF, gerade	Buchse, 1/2" 20UNF, abgewinkelt
5	5		3	
Federzugklemmen	Schraubklemmen			
XZ CC12FDB50R	XZ CC12FDM50B	XZ CC12FCM50B	XZ CC20FDM30B	XZ CC20FCM30B
-	-			
0,050	0,020			
Schraubanschluss (Metall-Spannring)				
IP 67 (bei korrektem Schraubanschluss)			IP 67 (bei korrektem Schraubanschluss)	
- 40...+ 85 °C			- 40...+ 85 °C	
Schraubklemmen. Max. Leiterquerschnitt: 0,5 mm ² . Leitungsdurchmesser: 4...8 mm	Schraubklemmen. Max. Leiterquerschnitt: 0,75 mm ² . Kabelverschraubung Pg 7. Leitungsdurchmesser: 3...6 mm			
-	-		-	
~ 30 V, --- 36 V	~ 30 V, --- 36 V		~ 250 V	
4 A	3 A		4 A	
> 10 ¹² Ω	> 10 ¹² Ω		> 10 ¹² Ω	
≤ 8 mΩ	≤ 8 mΩ		≤ 8 mΩ	

XZ CC12FDB50R

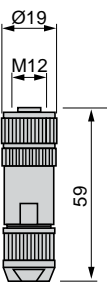

XZ CC12FDM50B

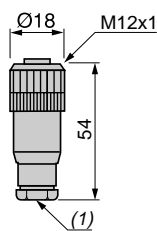

XZ CC12FCM50B

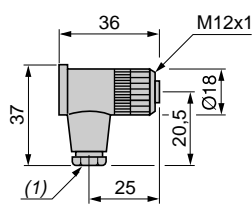

XZ CC20FDM30B

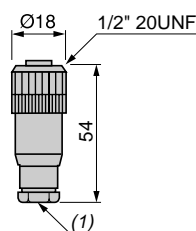

XZ CC20FCM30B

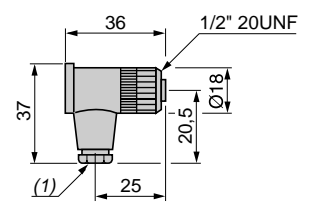

(1) Kabelverschraubung Pg 7

XZ CC12FDB50R, XZ CC12FDM50B



XZ CC20FDM30B

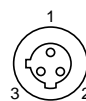

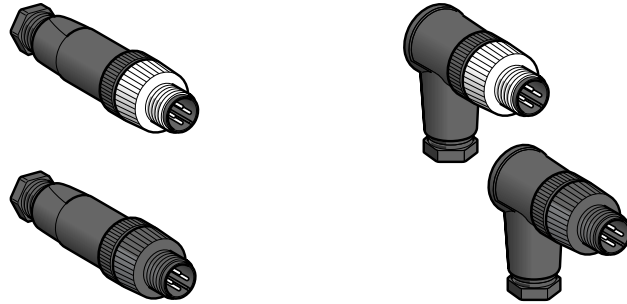

Ausführung	Stecker, M12, gerade	Stecker, M12, abgewinkelt
Anzahl Kontakte	4	
Anschlussstyp	Schraubklemmen	

Bestelldaten

Kunststoff-Gehäuse	Metall-Spannring	XZ CC12MDM40B	XZ CC12MCM40B
	Kunststoff-Spannring	XZ CC12MDP40B	XZ CC12MCP40B
Gewicht (kg)	0,025		

Technische Daten

Anschlussart	Schraubanschluss (Kunststoff- oder Metall-Spannring, je nach Ausführung)
Schutzart	IP 67 (bei korrektem Schraubanschluss)
Umgebungstemperatur	- 40...+ 85 °C
Anschluss	Schraubklemmen. Max. Leiterquerschnitt: 0,75 mm ² . Kabelverschraubung Pg 7. Leitungsdurchmesser: 3...6 mm
Funktionsanzeige mit LED	–
Bemessungsspannung	~ 125 V, = 150 V
Bemessungsstrom	3 A
Isolationswiderstand	> 10 ¹² Ω
Widerstand der Kontakte	≤ 8 mΩ

Abmessungen

XZ CC12MD●40B

XZ CC12MC●40B, XZ CC12MCP42B

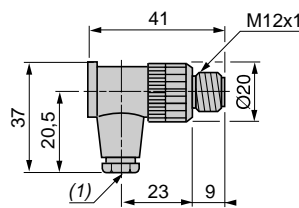
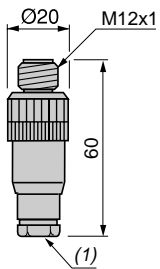

(1) Kabelverschraubung Pg 7

Anschlüsse

XZ CC12MD●40B, XZ CC12MC●40B, XZ CC12MCP42B



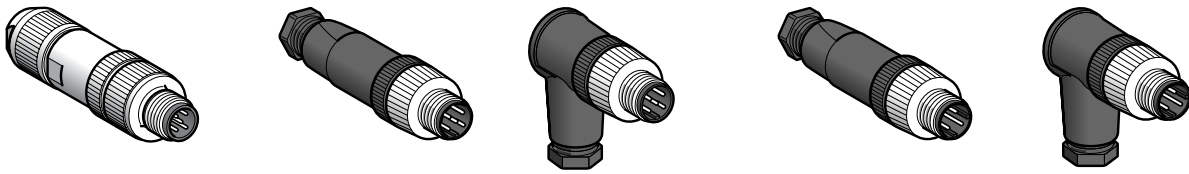

Stecker, M12, gerade, geschirmt	Stecker, M12, abgewinkelt	Stecker, M12, abgewinkelt	Stecker, 1/2" 20UNF, gerade	Stecker, 1/2" 20UNF, abgewinkelt
5	5		3	
Federzugklemmen	Schraubklemmen			

XZ CC12MDB50R	XZ CC12MDM50B	XZ CC12MCM50B	XZ CC20MDM30B	XZ CC20MCM30B
0,050	0,025			

Schraubanschluss (Metall-Spannring)

IP 67 (bei korrektem Schraubanschluss)

- 40...+ 85 °C

Federzugklemmen Max. Leiterquerschnitt: 0,5 mm ² . Leitungsdurchmesser: 4...8 mm	Schraubklemmen. Max. Leiterquerschnitt: 0,75 mm ² . Kabelverschraubung Pg 7. Leitungsdurchmesser: 3...6 mm
---	--

-	-	-
~ 30 V, ≍ 36 V	~ 30 V, ≍ 36 V	~ 250 V
4 A	3 A	4 A
> 10 ¹² Ω	> 10 ¹² Ω	> 10 ¹² Ω
≤ 8 mΩ	≤ 8 mΩ	≤ 8 mΩ

XZ CC12MDB50R	XZ CC12MDM50B	XZ CC12MCM50B	XZ CC20MDM30B	XZ CC20FCM30B
----------------------	----------------------	----------------------	----------------------	----------------------

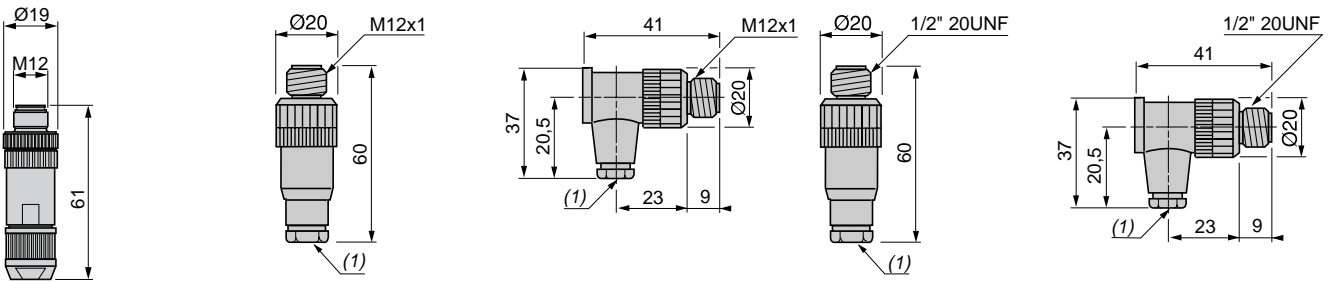

(1) Kabelverschraubung Pg 7

XZ CC12MDB50R, XZ CC12M●M50B	XZ CC20M●M30B
-------------------------------------	----------------------



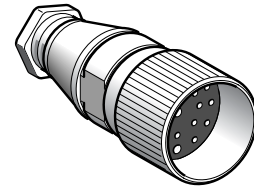
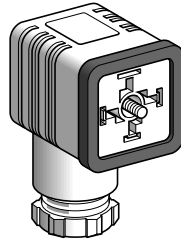

Ausführung	Buchse, DIN 43650 A, abgewinkel	Buchse, M23, gerade	
Anzahl Kontakte	4	19	
Anschlussstyp	Schraubklemmen	Lötstifte	
Bestelldaten			
Metall-Gehäuse und -Spannring	Kontaktnumerierung entgegen Uhrzeigersinn	XZ CC43FCP40B	XZ CC23FDM190S
Gewicht (kg)		0,035	0,080
Technische Daten			
Anschlussart	Schrauben	Schraubanschluss (Metall-Spannung)	
Schutzart	IP 65 (bei korrektem Schraubanschluss)		
Umgebungstemperatur	- 40...+ 125 °C	- 25...+ 110 °C	
Anschluss	Schraubklemmen. Max. Leiterquerschnitt: 1,5 mm². Kabelverschraubung Pg 11. Leitungsdurchmesser: 7...10 mm	Lötstifte. Max. Leiterquerschnitt: 1 mm² Kabelverschraubung Pg 13,5. Leitungsdurchmesser: 9...12 mm	
Funktionsanzeige mit LED	–	–	
Bemessungsspannung	~ 250 V	~ 60 V, --- 75 V	
Bemessungsstrom	16 A	7,5 A	
Isolationswiderstand	> 10 ⁸ Ω	> 10 ¹⁶ Ω	
Widerstand der Kontakte	≤ 4 mΩ	≤ 5 mΩ	

Abmessungen

XZ CC43FCP40B

XZ CC23FDM190S

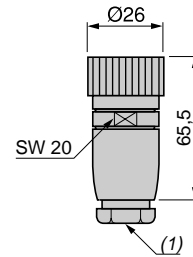
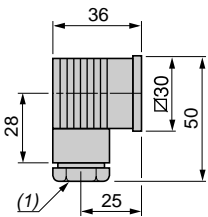

(1) Kabelverschraubung Pg 9

(1) Kabelverschraubung Pg 13

Anschlüsse

XZ CC43FCP40B

XZ CC23FDM190S

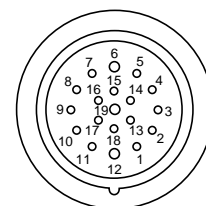
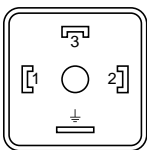

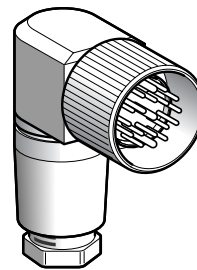
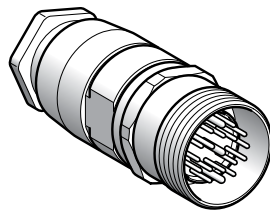

Buchse, M23, abgewinkelt	Stecker, M23, gerade	Stecker, M23, abgewinkelt (kompatibel mit den Schaltschrank-Durchführungsadaptern ABE 7ACC82)
--------------------------	----------------------	---

19

Lötstifte

XZ CC23FCM190S

XZ CC23MDM190S

XZ CC23MCM190S

0,150

0,080

0,150

Schraubanschluss (Metall-Spanning)

IP 65 (bei korrektem Schraubanschluss)

- 25...+ 110 °C

Lötstifte.
 Max. Leiterquerschnitt: 1 mm²
 Kabelverschraubung Pg 13,5.
 Leitungsdurchmesser: 9...12 mm

~ 60 V, --- 75 V

7,5 A

> 10¹⁶ Ω

≤ 5 mΩ

XZ CC23FCM190S

XZ CC23MDM190S

XZ CC23MCM190S

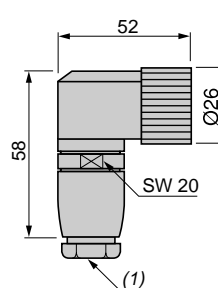
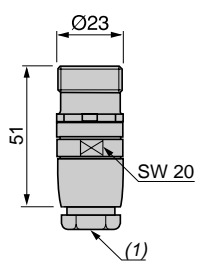
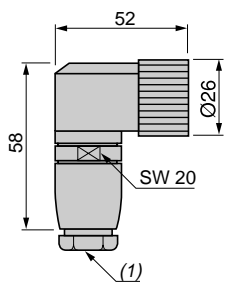

(1) Kabelverschraubung Pg 13

XZ CC23M•M190S

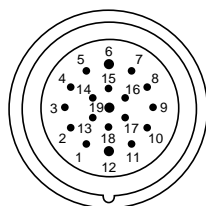

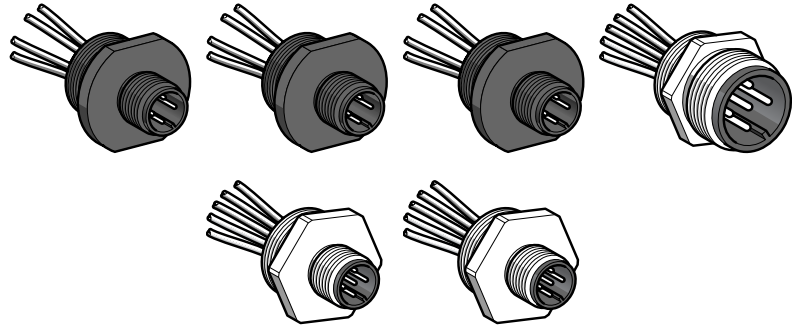

Ausführung, 5-polig	M12, Stecker		7/8" 16UN, Stecker
Passendes Einbaugewinde	11 (Pg 11)	13 (Pg 13,5)	M20 x 1,5

Bestelldaten

Anschluss 4 Leiter, Kunststoffgehäuse	XZ CE11P124M	XZ CE13P124M	XZ CE03P124M	–
Anschluss 5 Leiter, Metallgehäuse	–	XZ CE13M125M	XZ CE03M125M	XZ CE13M785M
Gewicht (kg)	0,020	0,020 (4 Leiter), 0,025 (5 Leiter)		0,050

Technische Daten

Anschlussart	Schraubanschluss		
Schutzart	IP 67		
Umgebungstemperatur	- 25...+ 80 °C		
Verdrahtung	Adern, 100 mm lang. Mit Aderendhülsen.		
Leiterdurchmesser	4 x 0,34 mm ²	XZ CE●3P124M: 4 x 0,34 mm ² XZ CE●3M125M: 4 x 0,34 mm ² + 1 x 0,5 mm ²	5 x 1 mm ²
Bemessungsspannung	~ 250 V, ≐ 300 V	XZ CE●3P124M: ~ 250 V, ≐ 300 V XZ CE●3M125M: ~ 30 V, ≐ 36 V	~ 250 V, ≐ 300 V
Bemessungsstrom	4 A		6 A
Isolationswiderstand	> 10 ⁹ Ω		
Widerstand der Kontakte	≤ 5 mΩ		

Abmessungen

XZ CE11P124M	XZ CE●3P124M	XZ CE●3M125M	XZ CE13M785M
--------------	--------------	--------------	--------------

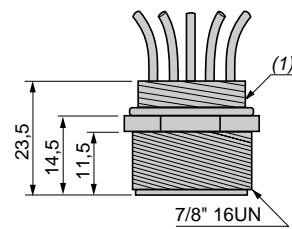
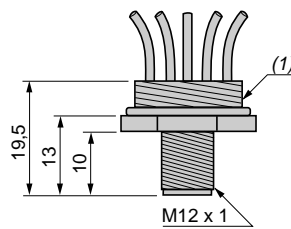
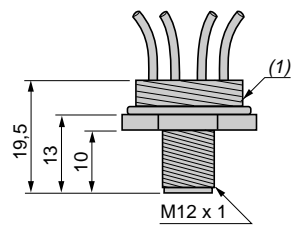
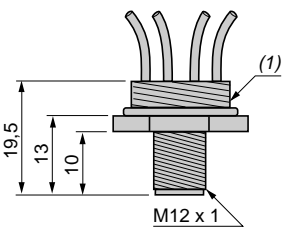

(1) Gewinde 11

(1) Gewinde 13 oder M20 x 1,5

(1) Gewinde 13 oder M20 x 1,5

(1) Gewinde 13

Anschlüsse

XZ CE●●P124M	XZ CE●●P125M	XZ CE13M785M
--------------	--------------	--------------

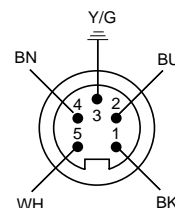
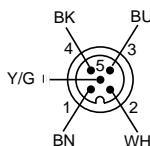
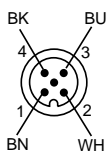

806083

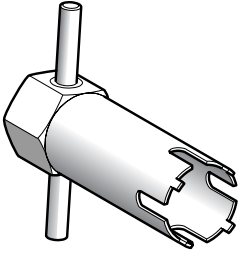

XZ CG0223

806082



XZ LG102

806081

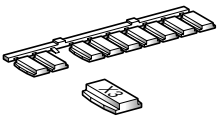

XZ LG101

806084

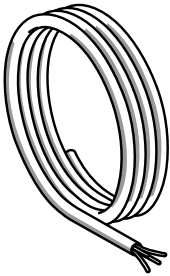

XZ CB4L●●●●

Zubehör

Beschreibung	Bestell-Nr.	Gewicht kg	
Montageschlüssel für Steckverbinder M23	XZ CG0223	0,120	
Abdeckungen für Buchsen M12 (Verpackungseinheit: 10 Stück)	XZ LG102	0,005	
Bezeichnungsschilder für Verteilermodule (Streifen mit 10 Schildern)	XZ LG101	0,010	
Kabel PVR, 4 x 0,5 mm² (Technische Daten s. Seite 8/7)	L = 25 m	XZ CB4L0025	1,115
	L = 50 m	XZ CB4L0050	2,220
	L = 100 m	XZ CB4L0100	4,490