Cloud connected sensor XIOT range

Catalogue



Simply easy!™



Cloud connected sensor XIOT range

For remote device monitoring

■ Cloud connected switch	
□ General presentation	page 2
□ References	page 3
□ Functions	page 4
□ Presentation of the transmitter	page 5
□ Characteristics of the transmitter	page 6
□ Dimensions of the transmitter	page 7
□ Connections of the transmitter	page 7
■ Product reference index	page 8

Cloud connected switch XIOT range



XIOT Cloud connected sensor
Click to view video (1 min 36 s)

The Internet of Things (IoT) is the extension of the Internet to connected devices. Telemecanique Sensors offers a wireless solution to collect data from remote equipment and use this data, via the Internet, on a PC or mobile device.

The XIOT Cloud connected switch from Telemecanique Sensors is based on LPWAN (low power wide area network) technology, operated by Sigfox.

The Sigfox network covers 32 countries and is already very extensive in Europe. It is also being rapidly deployed in the US and Asia-Pacific. It uses antennas with a range of around 50 km.

The map on the Sigfox website shows exactly which areas are covered by the network (see <https://sigfox.com/en/coverage>).

When the contacts on a switch installed on your site change state **1**, the transmitter **2** sends a message to the IoT network (LPWAN) **3**, which is then routed to our secure servers **4**.

This message is then delivered to one or more recipients as an alert on PC, tablet, or smartphone **5**.

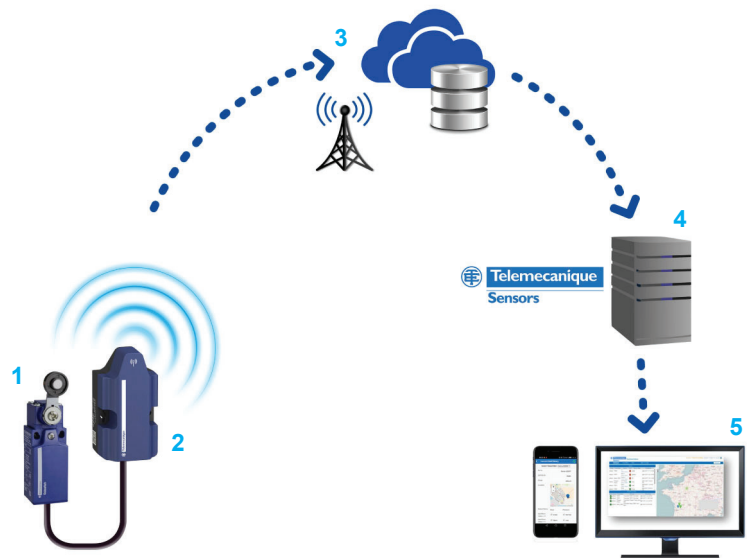

For areas without electricity or difficult-to-access areas

The XIOT Cloud connected switch is used to signal a significant or abnormal change of state on your devices.

> **Agricultural applications**

- > Irrigation systems (pressure threshold monitoring)
- > Buildings and hoisting equipment (hatch and door positions)
- > HVAC

> **Water treatment applications** (pumping, tank monitoring)

- > Water treatment plants
- > Valves
- > Flood gates

> **Mining and quarrying applications** (Emergency stop monitoring)

- > Conveyors

* EcoStruxure™ is Schneider Electric's IoT platform.

Cloud connected switch

XIOT range

For remote device monitoring



Real-time alerts via the Cloud

The XIOT Cloud connected switch gives you precise, reliable data about your installations in real time.

You can configure this data to suit your requirements for:

- > Operation
- > Receiving alerts
- > Event history, etc.

The information can be received by one or more recipients on a PC, tablet, or smartphone in the form of e-mails and notifications. Connections are also offered for integrating data in SCADA (supervisory control and data acquisition) systems.

Reduce operational downtime

- > Optimized production
- > Direct alert delivered to the relevant recipients
- > Easy diagnostics

Prevent and reduce maintenance

- > For greater machine availability
- > For greater process reliability



3 options to choose from

Description	Transmitter only	Prepaid 5-year access to Cloud	Subscription services (1)
	XIOT11SE0MRCL	XIOT11SE5MRCL	XIOT11SERMRCL
> 1 standalone transmitter	<input checked="" type="checkbox"/>	<input checked="" type="checkbox"/>	<input checked="" type="checkbox"/>
> Activation magnet	<input checked="" type="checkbox"/>	<input checked="" type="checkbox"/>	<input checked="" type="checkbox"/>
> Instruction sheet	<input checked="" type="checkbox"/>	<input checked="" type="checkbox"/>	<input checked="" type="checkbox"/>
> 5-year subscription to Sigfox LPWAN (2)	<input type="checkbox"/>	<input checked="" type="checkbox"/>	<input type="checkbox"/>
> Web interface to configure and display data	<input type="checkbox"/>	<input checked="" type="checkbox"/>	<input checked="" type="checkbox"/>
> Smartphone apps for alert notifications (iOS and Android)	<input type="checkbox"/>	<input checked="" type="checkbox"/>	<input checked="" type="checkbox"/>
> Connection to Telemecanique Sensors secure servers via external SCADA system for data processing	<input type="checkbox"/>	<input type="checkbox"/>	<input checked="" type="checkbox"/>

References

Description	Reference	Weight kg
Transmitter only	XIOT11SE0MRCL	0.216
Prepaid 5-year access to Cloud	XIOT11SE5MRCL	—
Subscription services	XIOT11SERMRCL	—

(1) Pricing and terms and conditions available on the online payment site:

<https://godigital.schneider-electric.com/smp/home/home.page>

(2) LPWAN: Low power wide area network

Cloud connected switch

XIOT range

For remote device monitoring

Operating tools

Configuration/Access to user data from a web browser (<https://xiot.tesensors.com>)

- > Creation of a password-protected user account
- > Enrollment and configuration of transmitters linked to the account:
- > Configuration of alerts:
 - Opening and/or closing of contacts connected to the transmitter
 - Discharge of internal battery
 - Abnormal frequency of transmission
 - Type (e-mail, notification on smartphone)
 - Recipient(s)
- > Geographical location of transmitter (manual entry)

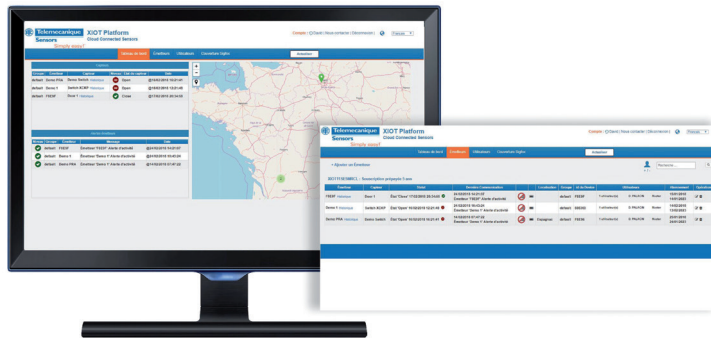

Operation

- > State of each contact connected to each transmitter
- > History of events transmitted by each transmitter
- > Quality of signal received from each transmitter
- > Online purchase of services at <https://godigital.schneider-electric.com/smp/home/home.page> (for XIOT11SE0MRCL reference only)

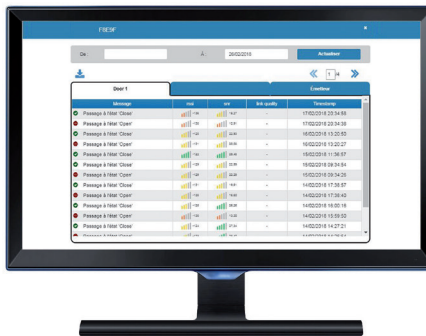

Dedicated smartphone app

- > Available for iOS and Android, this app can be used to receive alert notifications from transmitters (requires Internet access).
- > The app can also be used to display the state of all transmitters linked to the user account and to enroll a transmitter to an account by scanning its QR code.

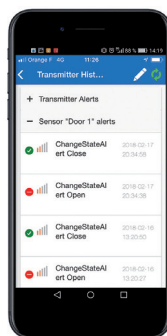

Standalone transmitter connected via LPWAN radio link ⁽¹⁾

XIOT range

For remote device monitoring

IP66 transmitter for indoor or outdoor applications (-25 °C to +70 °C)



- 1 : PBT case
- 2 : 2 holes for screw mounting
- 3 : 2 m PVC cable for connection to the switch

Rugged standalone transmitter

Up to 10 years of standalone operation

- > Powered by built-in Lithium battery with a lifespan of over 5 years (up to 10 years for 2 frames/day)
- > IP 66 protection provided by a sealed case with one cable outlet (PVC, 4-wire, for connecting 2 volt-free contacts)
- > Transmitter can be enrolled from a smartphone app or via a web page
- > Supplied with external magnet for activation purposes
- > Screw mounting

A complete offer of associated switches ⁽²⁾

XM pressure switches

- > Electromechanical pressure and vacuum switches for control circuits
- > Fluids detected: air, fresh water, sea water, hydraulic oils, corrosive fluids, and viscous fluids

XC limit switches

- > Metal or plastic limit switches, miniature or standard format, industrial EN 50041 format, compact CENELEC EN 50047 format, etc.
- > Dedicated limit switches for hoisting, material handling, and conveyor belt shift monitoring applications



NB: The XIOT Cloud connected switches are operated on radio networks which can be perturbed by external sources. In addition, a permanent access to data and services through internet is dependent to third party operators and cannot be ensured at 100%. Therefore, the system must not be used for critical alerts.

(1) LPWAN: Low power wide area network

(2) Please consult our website www.tesensors.com.

Standalone transmitter connected via LPWAN radio link ⁽¹⁾

XIOT range

For remote device monitoring

Electrical characteristics			
		Transmitter	
Power supply	Type		Built-in Lithium battery
	Voltage	V	3.6
	Battery life		13.6 years for 2 frames/day 4.2 years for 10 frames/day 2.3 years for 20 frames/day
Inputs	Type		2 low-level inputs (3 V/6 μA), volt-free contacts
	Filtering		100 ms
	Detection level		State 1 > 1.7 V State 0 > 0.7 V
Compatibility	With limit switches		XCM, XCKM, XCKL, XCKS, XCKJ, XCKN, XCKP, XCKT, XCKD, and XCRT ⁽²⁾
	With pressure switches		XMLA, XMLB, XMLC, and XMLD ⁽²⁾
Mechanical characteristics			
Connection			Via 2 m PVC cable Number of wires and cross sectional area: 4 x 0.34 mm ² /AWG 22
Materials			PBT and PA case
Mounting			Screws (2 x 4 mm) Maximum tightening torque: 3 Nm/26.6 lb-in
Dimensions (W x H x D)		mm	50 x 100 x 45
		in.	1.96 x 3.94 x 1.77
Weight			0.216 kg/0.478 lb
Radio characteristics			
Power			14 dBm (25 mW)
Frequency	Europe		868 MHz
Range			Up to 10 km
Network coverage			See the map on the following website: https://sigfox.com/en/coverage The XIOT smartphone app also offers a network coverage checker to find out the signal strength: https://xiot.tesensors.com
Transmission	Sending		On change of state of inputs + 1 status frame per day
	Frame transmission frequency		6/hour and 50/day maximum (1 frame for each change of state of one of the inputs)
	Frames		Sigfox format: 12 bytes, 100 bps
	Reception		No
	Activation		By external magnet supplied with the transmitter
Environment characteristics			
Product certifications			CE, Sigfox ready
Radio standards			EN 62368-1, EN 300-220, EN 301-489
Ambient temperature	For operation	°C	-25...+70 Do not exceed +65 °C and 85% relative humidity in permanent exposure conditions outdoors
Degree of protection			IP 66

(1) LPWAN: Low power wide area network

(2) Please consult our website: www.tesensors.com.

Dimensions

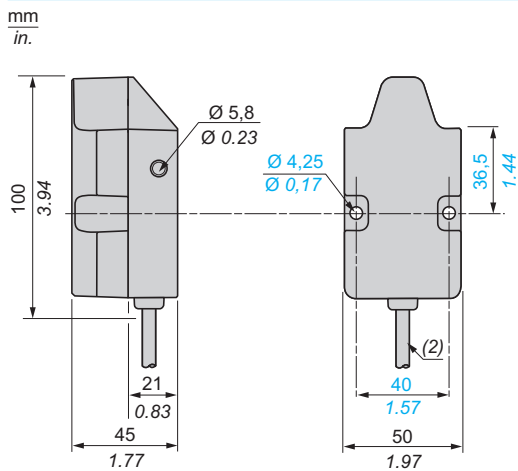

Connections

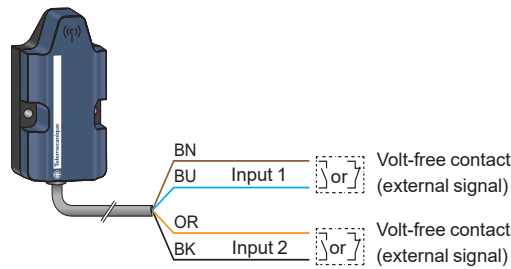

BN: Brown
BU: Blue
OR: Orange
BK: Black

Mounting precautions

Flat surface mounting

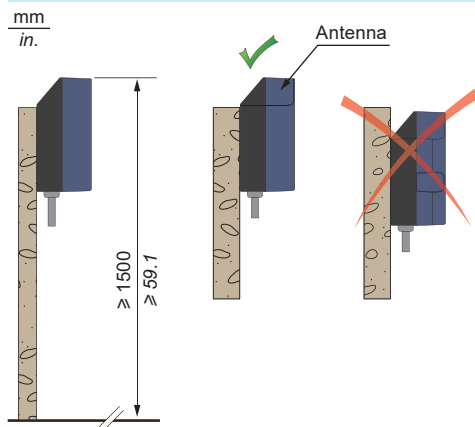

Free area

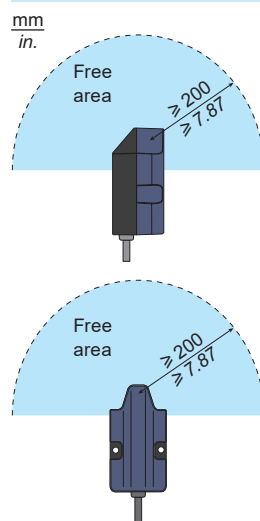

Mounting in a metal cabinet

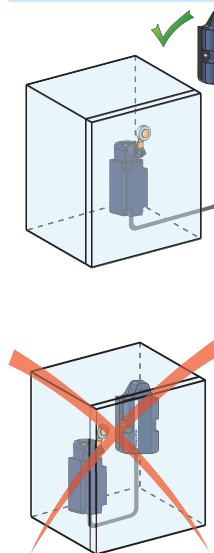

Signal attenuation according to the material

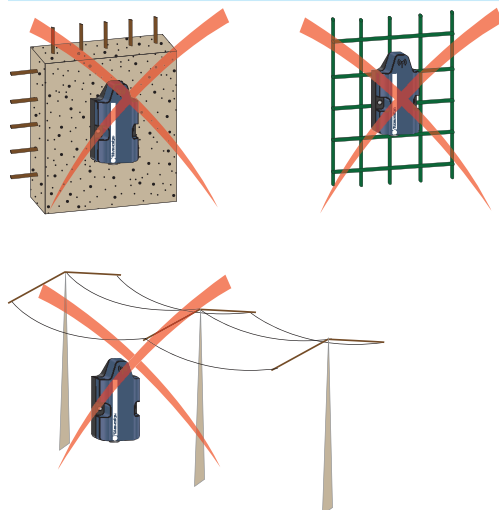

Material	Signal attenuation ⁽³⁾ %	Material attenuation db
Glass window	10...20	2
Plaster wall	20...30	3
Brick wall	50	6
Concrete wall	70...80	15
Metal structure	70...100	30
High voltage grid	50...90	20

⁽¹⁾ LPWAN: Low Power Wide Area Network

⁽²⁾ 2 m/6.6 ft cable

⁽³⁾ Values for indication purposes only. Actual values depend on the thickness and nature of the material

NB: If you wish to extend the cable to an overall length of more than 3 meters, you need to take the necessary installation precautions if there is any electrical equipment nearby. Keep the cable away from any equipment generating electromagnetic interference, such as transformers, power supply lines, electrical welding equipment, etc.

X	
XIOT11SE0MRCL	3
XIOT11SE5MRCL	3
XIOT11SERMRCL	3