

› GNA Series

Essential Solid State Relays

Panel Mount - AC Output Single Phase

- › Output current of 25, 40, 50 and 90 Amps
- › Output voltage of 24-280 V \sim and 48-660 V \sim
- › Control voltage of 4-32 V ---
- › Zero cross (resistive loads)
- › Integrated IP20 touch-safe removable covers
- › LED input status indicator
- › Cost-effective solution



Zero Cross
Version

Product Selection - Zero Cross (Resistive Loads)				
Rated Load Current	25A	40A	50A	90A
Output Voltage	24-280 V \sim	48-660 V \sim	48-660 V \sim	48-660 V \sim
Control Voltage				
4-32 V ---	84137910N	84137450N	84137460N	84137480N

PART NUMBERING SYSTEM

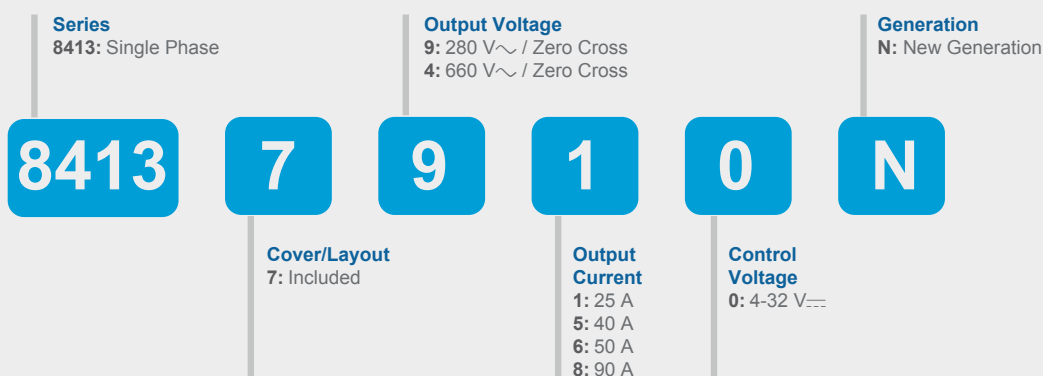

Do you need an adapted or customized solution? Contact us on www.crouzet.com

Description:

Crouzet Solid State Relays are designed to be used in almost any application, offering very long life expectancy and are easy to install, easy to use, robust and multipurpose.

For more information about Crouzet's Solid State relays, please visit www.crouzet.com.

Accessories		
Type	Description	Part-Number
Heatsink	0.9 °C/W Thermal Resistance	26532752N
Heatsink	1.1 °C/W Thermal Resistance	26532753N
Heatsink	1.2 °C/W Thermal Resistance	26532754N
Heatsink	1.75 °C/W Thermal Resistance	26532755N
Heatsink	2.2 °C/W Thermal Resistance	26532756N
Adapter	DIN Rail	26532764N
Thermal Pad	Self-Adhesive Thermal Pad	26532722N
Screws	Screw Mounting Kit	26532001
Thermal Grease	Thermal Grease for Heatsink mounting	26532003

Output Specifications ⁽¹⁾				
Description	25A	40A	50A	90A
Maximum Load Current [Arms] ⁽³⁾	25	40	50	90
Minimum Load Current [mArms]	5			
Min / Max Operating Voltage (47-63Hz) [Vrms]	24-280 V \sim	48-660 V \sim		
Transient Voltage [Vpk] ⁽²⁾	600	1200		
Maximum Off-State Leakage Current @ Rated Voltage [mArms]	1			
Minimum Off-State dV/dt @ Maximum Rated Voltage [V/ μ sec]	500			
1 Second Surge Current (Apk. Ta=25 °C) 50/60 Hz	100	96	165	347
Maximum 1 Cycle Surge Current (50/60Hz) [Apeak] Typ @ 50 Hz	270/284 (min) 340 (typ)	320/_ (min) 420 (typ)	530/_ (min) 580 (typ)	1100/_ (min) 1200 (typ)
Maximum On-State Voltage Drop @ Rated Current [Vpeak]	1.22	1.23	1.22	1.4
Thermal Resistance Junction to Case (Rjc) [°C/W]	1.7	0.7	0.55	0.3
Maximum 1/2 Cycle I ² t for Fusing @ 50 Hz (min. / typical) [A ² sec]	487	882	1680	7200
Minimum Heat Sink for Rated Current @ 40 °C [°C/W]	1.3	1.05	0.85	0.33

Input Specifications	
Description	4-32 V $_{DC}$
Input Voltage Range	4-32 V $_{DC}$ ^(1,2)
Maximum Reverse Voltage	-32 V $_{DC}$
Minimum Turn-On Voltage	3 V $_{DC}$ 3.5 V $_{DC}$
Must Turn-Off Voltage	1 V $_{DC}$ 2 V $_{DC}$
Minimum Input Current (for on-state)	10 mA
Maximum Input Current [mA]	14 mA
Nominal Input Impedance [Ohms]	Current Limited
Maximum Turn-On Time [msec]	1/2 Cycle ⁽⁵⁾
Maximum Turn-Off Time [msec]	1/2 Cycle ⁽⁵⁾

General Specifications				
Description	25A	40A	50A	90A
Dielectric Strength, Input to Output (50/60 Hz)	4000 Vrms			
Dielectric Strength, Input/Output to Ground (50/60 Hz)	2500 Vrms	4000 Vrms		
Minimum Insulation Resistance (@ 500 V $_{DC}$)	10 ⁹ Ω			
Maximum Capacitance, Input/Output	0.8 pF			
Ambient Operating Temperature Range	-40 to 80 °C			
Ambient Storage Temperature Range	-40 to 100 °C			

General Specifications				
Description	25A	40A	50A	90A
Weight (typical)	80 g			
Housing Material	UL94 V-0			
Baseplate Material	Aluminum			
Input Terminal Screw Torque Range (in-lb/Nm)	11-18 / 1.2-2.0			
Load Terminal Screw Torque Range (in-lb/Nm)	18-26 / 2-3			
SSR Mounting Screw Torque Range (in-lb/Nm)	11-16 / 1.2-1.8			
Humidity per IEC60068-2-78	40-85%			
LED Input Status Indicator	Green			
MTBF (Mean Time Between Failures) at 40 °C ambient temperature (years) ⁽⁵⁾	72			
MTBF (Mean Time Between Failures) at 60 °C ambient temperature (years) ⁽⁵⁾	46			

General Notes
⁽¹⁾ All parameters at 25 °C unless otherwise specified
⁽²⁾ Output will self trigger between 450-600 Vpk not suitable for capacitive loads
⁽³⁾ Heat sinking required, see derating curves
⁽⁴⁾ Increase minimum voltage by 1 V for operations from -20 to -40 °C
⁽⁵⁾ All parameters at 50 % power rating and 100 % duty cycle (contact tech support for detailed report)

Diagrams

Wiring

GNA

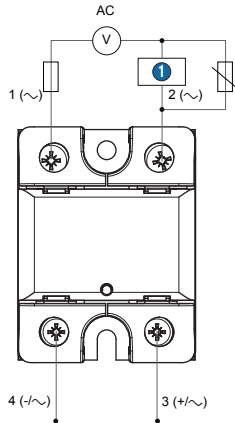

TERMINALS	WIRE SIZE		Terminal Screw Torque (N.m)
	SOLID	STRANDED	
Input	18..14 AWG (0.75..2.5 mm ²)	18..14 AWG (0.75..2.5 mm ²)	1.2 - 2
	2 x 18..14 AWG (0.75..2.5 mm ²)	2 x 18..14 AWG (0.75..2.5 mm ²)	
Output	16..8 AWG (1.5..10 mm ²)	16..8 AWG (1.5..6 mm ²)	2 - 3
	2 x 16..8 AWG (1.5..10 mm ²)	2 x 16..10 AWG (1.5..6 mm ²)	

Recommended overvoltage external protection: TVS Diode

1 Load

Diagrams

Equivalent Circuit Block

GNA Series DC control / Thyristor 40 A / 50 A / 90 A

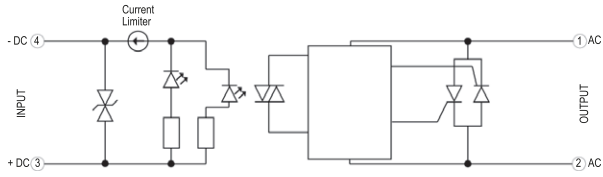

Input current vs Input Voltage
Standard Regulated DC inputs

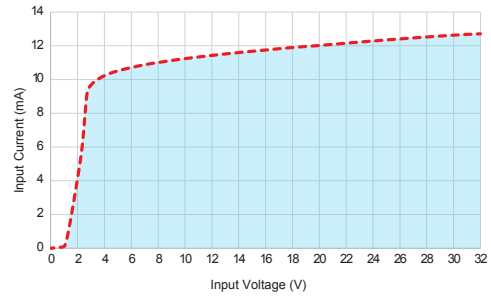

GNA Series DC control / Triac 25 A

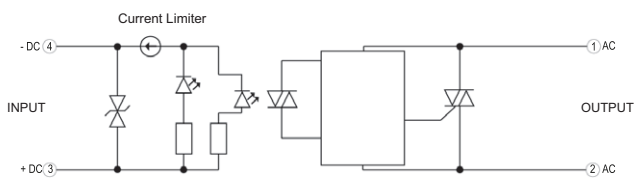

Input current vs Input Voltage
Standard Regulated DC inputs

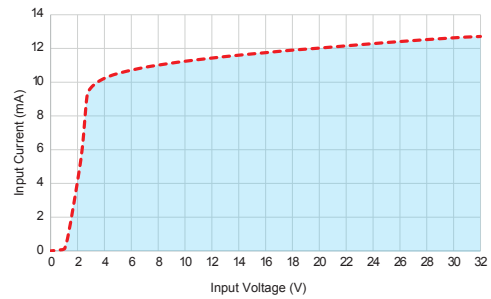

Diagrams

Dimensions (mm)

GNA front view

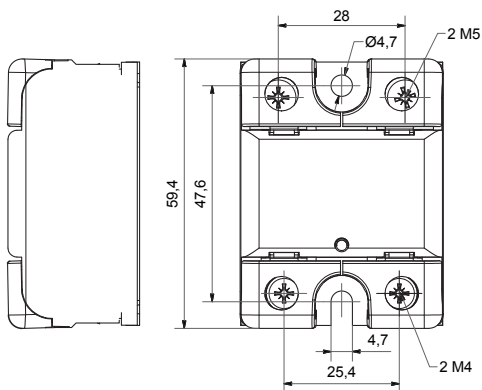

GNA side view

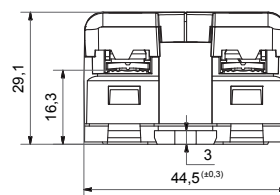

Curves

Surge Current Information

GNA - 25 A

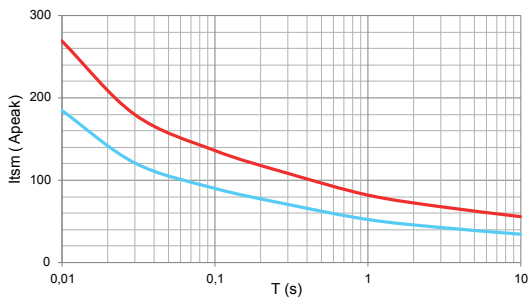

GNA - 40 A

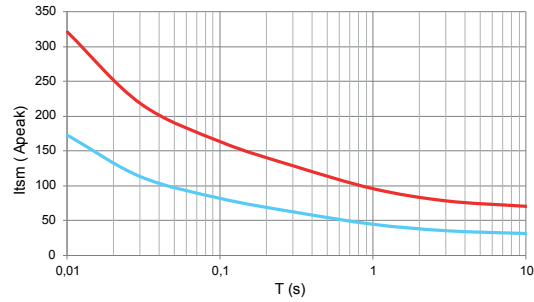

GNA - 50 A

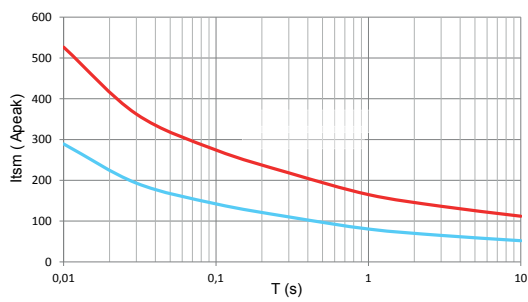

GNA - 90 A

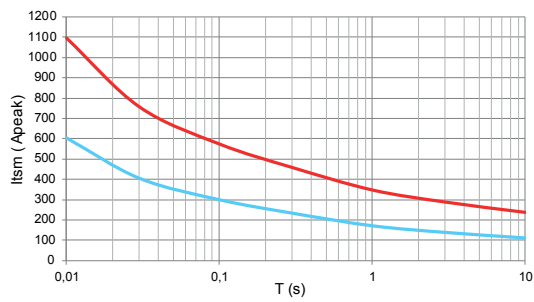

Curves

Thermal Derating Curves

GNA - 25 A

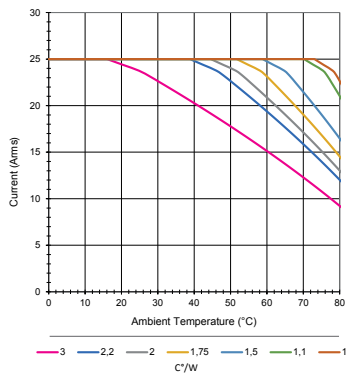

GNA - 40 A

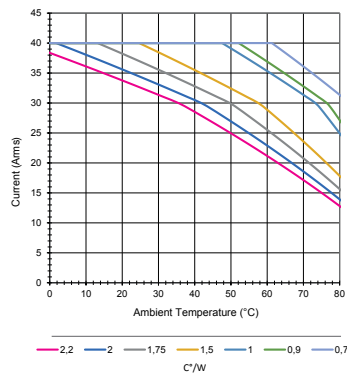

GNA - 50 A

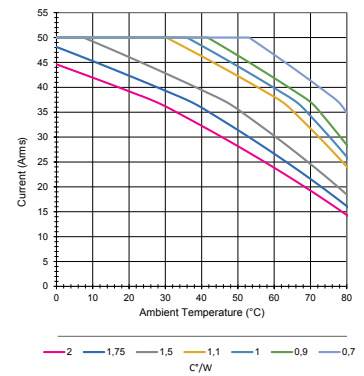

GNA - 90 A

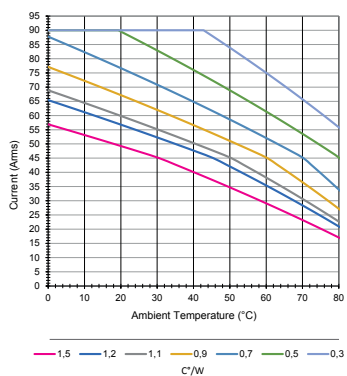

Standards Specifications

IEC/EN61000-4-4 (bursts)	2 kv crit B
IEC/EN61000-4-5 (surge)	2 kv crit B
VIBRATION resistance IEC 60068-2-6	10 g
SHOCK resistance IEC 60068-2-27	50 G (11 ms)



* VDE ONLY 84137450N / 84137460N / 84137480N

Warning:

The product information contained in this catalogue is given purely as information and does not constitute a representation, warranty or any form of contractual commitment. Crouzet and its subsidiaries reserve the right to modify their products without notice. It is imperative that we should be consulted over any particular use or application of our products and it is the responsibility of the buyer to establish, particularly through all the appropriate tests, that the product is suitable for the use or application. Under no circumstances will our warranty apply, nor shall we be held responsible for any application (such as any modification, addition, deletion, use in conjunction with other electrical or electronic components, circuits or assemblies, or any other unsuitable material or substance) which has not been expressly agreed by us prior to the sale of our products.