

# Adjustable Range Reflective Photoelectric Sensor **Amplifier Built-in**

## RX-LS200

**Related Information**

- General terms and conditions ..... F-3
- Selection guide ..... P.231~
- Glossary of terms ..... P.1549~
- General precautions ..... P.1552~

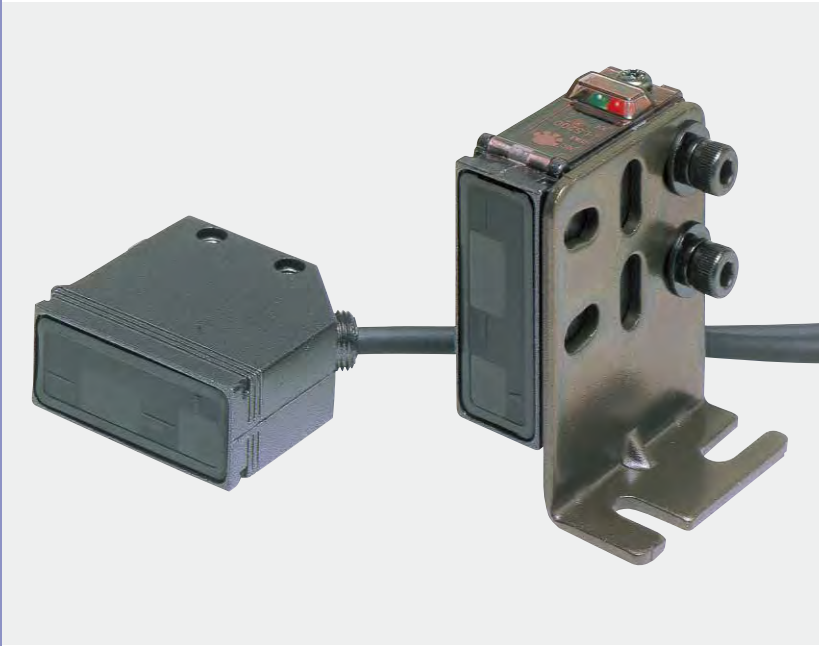

### Detection of different colored objects at a certain distance

#### Hardly affected by color

The color or size of the object does not affect its sensing performance.

#### Robust

Its robust enclosure is made of die-cast zinc alloy.

#### Hardly affected by background

The sensor does not detect the background beyond the set distance since it is of distance adjustable type.

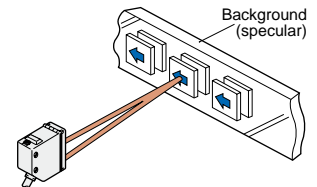

(However, changing the angle of the sensor is necessary when the background object has a specular surface.)

### ENVIRONMENTAL RESISTANCE

#### Waterproof IP67 (IEC)

The equipment on which the sensor is mounted can be washed without any problem.

Note: However, take care that if it is exposed to water splashes during operation. It may detect a water drop itself.

#### Insusceptible to dust

The sensing performance is less affected by dust as it does not depend on the incident light intensity.

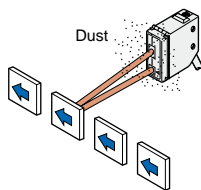

### BASIC PERFORMANCE

#### High-speed response time: 1 ms

It can be used on a high speed assembly line.

#### Adjustable Range Reflective Type

The sensing range for which the sensor detects an object is determined by the incident beam angle, regardless of the incident light intensity.

#### RX-LS200

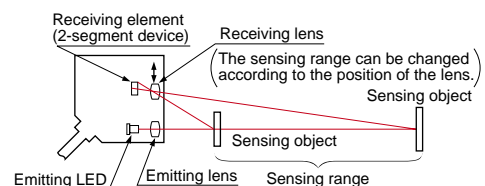

- FIBER SENSORS
- LASER SENSORS
- PHOTOELECTRIC SENSORS
- MICRO PHOTOELECTRIC SENSORS
- AREA SENSORS
- SAFETY LIGHT CURTAINS / SAFETY COMPONENTS
- PRESSURE / FLOW SENSORS
- INDUCTIVE PROXIMITY SENSORS
- PARTICULAR USE SENSORS
- SENSOR OPTIONS
- SIMPLE WIRE-SAVING UNITS
- WIRE-SAVING SYSTEMS
- MEASUREMENT SENSORS
- STATIC CONTROL DEVICES
- LASER MARKERS
- PLC
- HUMAN MACHINE INTERFACES
- ENERGY MANAGEMENT SOLUTIONS
- FA COMPONENTS
- MACHINE VISION SYSTEMS
- UV CURING SYSTEMS
- Selection Guide
- Amplifier Built-in
- Power Supply Built-in
- Amplifier-separated
- EX-Z
- CX-400
- CY-100
- EX-10
- EX-20
- EX-30
- EX-40
- CX-440
- EQ-30
- EQ-500
- MQ-W
- RX-LS200
- RX
- RT-610

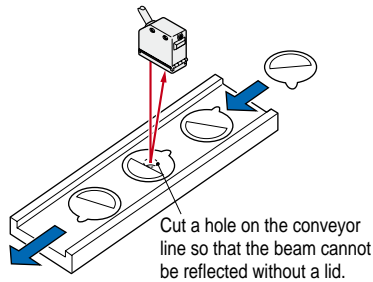
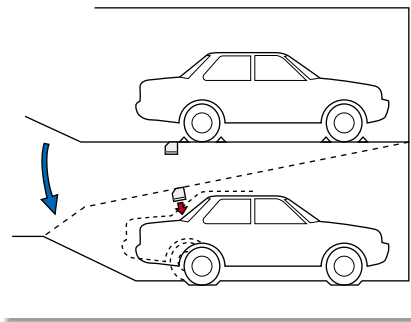
**APPLICATIONS****Detecting lids of cups****Safekeeping at parking garage****ORDER GUIDE**

Type	Appearance	Sensing range	Model No.	Output
NPN output		50 to 200 mm 1.969 to 7.874 in	<b>RX-LS200</b>	NPN open-collector transistor
PNP output			<b>RX-LS200-P</b>	PNP open-collector transistor

**5 m cable length type**

5 m **16.404 ft** cable length type (standard: 3 m **9.843 ft**) is also available for NPN output type.  
Model No.: **RX-LS200-C5**

**Accessory**

- **MS-RX-1** (Sensor mounting bracket)

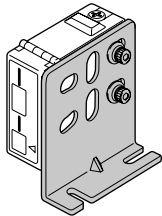

Two M4 (length 16 mm **0.630 in**) hexagon-socket-head bolts are attached.

**OPTIONS**

Designation	Model No.	Description	
Narrow-view slit mask	<b>OS-RXL-1</b>	Slit size	The sensing view is narrowed laterally so that the effect of the object's surroundings is reduced.
	<b>OS-RXL-2</b>		
	<b>OS-RXL-3</b>		
Protective tube	<b>PT-RX500</b>	Length	Cable is protected from external forces. It does not rust as it is made of stainless steel.
	<b>PT-RX1000</b>		

**Narrow-view slit mask**

- **OS-RXL-□**

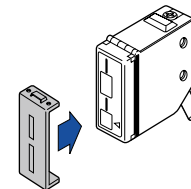
**Protective tube**

- **PT-RX500**
- **PT-RX1000**

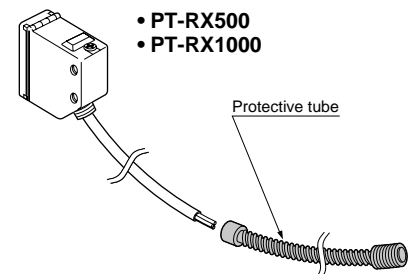

FIBER SENSORS

LASER SENSORS

PHOTO-ELECTRIC SENSORS

MICRO PHOTO-ELECTRIC SENSORS

AREA SENSORS

SAFETY LIGHT CURTAINS / SAFETY COMPONENTS

PRESSURE / FLOW SENSORS

INDUCTIVE PROXIMITY SENSORS

PARTICULAR USE SENSORS

SENSOR OPTIONS

SIMPLE WIRE-SAVING UNITS

WIRE-SAVING SYSTEMS

MEASUREMENT SENSORS

STATIC CONTROL DEVICES

LASER MARKERS

PLC

HUMAN MACHINE INTERFACES

ENERGY MANAGEMENT SOLUTIONS

FA COMPONENTS

MACHINE VISION SYSTEMS

UV CURING SYSTEMS

Selection Guide

Amplifier Built-in

Power Supply Built-in

Amplifier-separated

**EX-Z****CX-400****CY-100****EX-10****EX-20****EX-30****EX-40****CX-440****EQ-30****EQ-500****MQ-W****RX-LS200****RX****RT-610**

**SPECIFICATIONS**

Item	Model No.	Adjustable range reflective	
		NPN output type <b>RX-LS200</b>	PNP output type <b>RX-LS200-P</b>
CE marking directive compliance	EMC Directive, RoHS Directive		
Sensing range	50 to 200 mm <b>1.969 to 7.874 in</b> with white non-glossy paper (50 × 50 mm <b>1.969 × 1.969 in</b> )		
Hysteresis	10 % or less of operation distance with white non-glossy paper (50 × 50 mm <b>1.969 × 1.969 in</b> )		
Repeatability	Along sensing axis: 1 mm <b>0.039 in</b> or less, Perpendicular to sensing axis: 0.5 mm <b>0.020 in</b> or less		
Supply voltage	12 to 24 V DC ±10 % Ripple P-P 10 % or less		
Current consumption	40 mA or less		
Output	NPN open-collector transistor <ul style="list-style-type: none"> <li>• Maximum sink current: 100 mA</li> <li>• Applied voltage: 30 V DC or less (between output and 0 V)</li> <li>• Residual voltage: 1.5 V or less (at 100 mA sink current) 0.4 V or less (at 16 mA sink current)</li> </ul>		PNP open-collector transistor <ul style="list-style-type: none"> <li>• Maximum source current: 100 mA</li> <li>• Applied voltage: 30 V DC or less (between output and +V)</li> <li>• Residual voltage: 1 V or less (at 100 mA source current) 0.4 V or less (at 16 mA source current)</li> </ul>
Utilization category	DC-12 or DC-13		
Output operation	Switchable either Light-ON or Dark-ON		
Short-circuit protection	Incorporated		
Response time	1 ms or less		
Operation indicator	Red LED (lights up when the output is ON)		
Stability indicator	Green LED (lights up under stable light received condition or stable dark condition)		
Distance adjuster	2-turn mechanical adjuster		
Environmental resistance	Pollution degree	3 (Industrial environment)	
	Protection	IP67 (IEC)	
	Ambient temperature	-25 to 60 °C <b>-13 to 140 °F</b> (No dew condensation or icing allowed), Storage: -30 to 70 °C <b>-22 to 158 °F</b>	
	Ambient humidity	35 to 85 % RH, Storage: 35 to 85 % RH	
	Ambient illuminance	Incandescent light: 3,500 lx or less at the light-receiving face	
	Voltage withstandability	1,000 V AC for one min. between all supply terminals connected together and enclosure	
	Insulation resistance	20 MΩ, or more, with 250 V DC megger between all supply terminals connected together and enclosure	
	Vibration resistance	10 to 500 Hz frequency, 1.5 mm <b>0.059 in</b> double amplitude (10 G max.) in X, Y and Z directions for two hours each	
Shock resistance	500 m/s <sup>2</sup> acceleration (50 G approx.) in X, Y and Z directions three times each		
Emitting element	Infrared LED (peak emission wavelength: 880 nm <b>0.035mil</b> , modulated)		
Material	Enclosure: Die-cast zinc alloy, Indicator cover: Polyethersulphone, Lens: Polycarbonate		
Cable	0.15 mm <sup>2</sup> 3-core oil, heat and cold resistant cabtyre cable, 3 m <b>9.843 ft</b> long		
Cable extension	Extension up to total 100 m <b>328.084 ft</b> is possible with 0.3 mm <sup>2</sup> , or more, cable.		
Weight	Net weight: 85 g approx.		
Accessories	<b>MS-RX-1</b> (Sensor mounting bracket): 1 set, Adjusting screwdriver: 1 pc.		

Note: Where measurement conditions have not been specified precisely, the conditions used were an ambient temperature of +23 °C **+73.4 °F**.

**I/O CIRCUIT AND WIRING DIAGRAMS**

**RX-LS200**

NPN output type

**I/O circuit diagram**

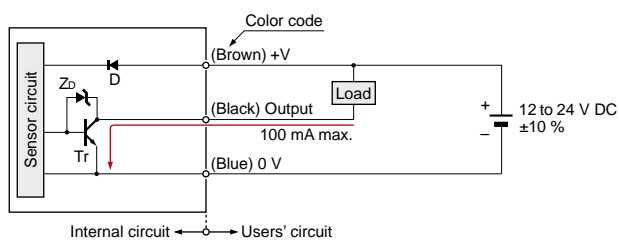

**Wiring diagram**

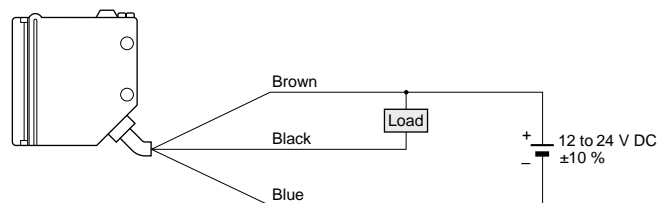

Symbols ... D : Reverse supply polarity protection diode  
 ZD: Surge absorption zener diode  
 Tr : NPN output transistor

**I/O CIRCUIT AND WIRING DIAGRAMS****RX-LS200-P**

PNP output type

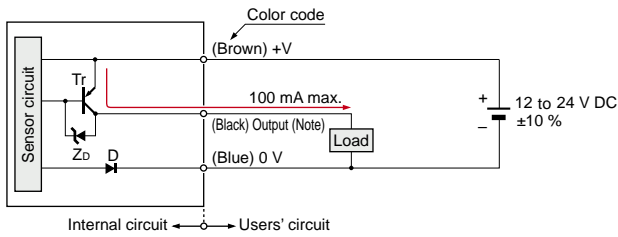
**I/O circuit diagram**

Note: The output does not incorporate a short-circuit protection circuit.  
Do not connect it directly to a power supply or a capacitive load.

Symbols ... D : Reverse supply polarity protection diode  
Zd : Surge absorption zener diode  
Tr : PNP output transistor

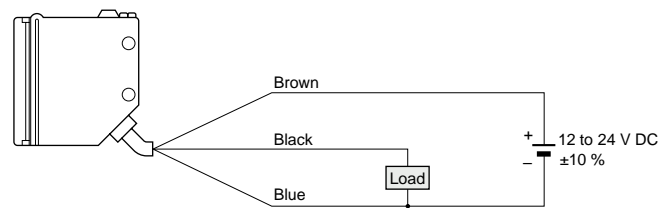
**Wiring diagram****SENSING CHARACTERISTICS (TYPICAL)****Sensing fields**

- Setting distance: 200 mm  
7.874 in (Horizontal)

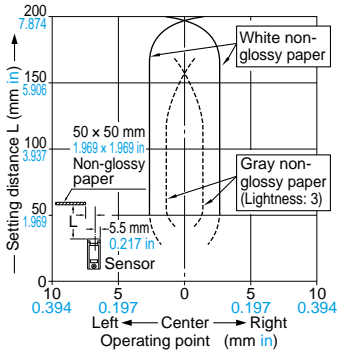

- Setting distance: 200 mm  
7.874 in (Vertical)

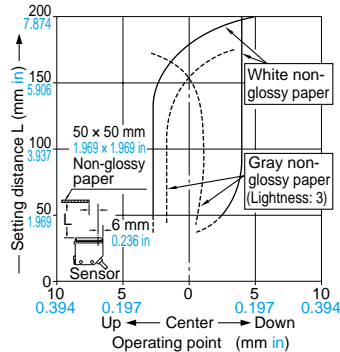

- Setting distance: 150 mm  
5.906 in (Horizontal)

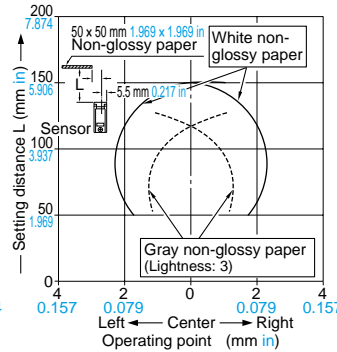

- Setting distance: 150 mm  
5.906 in (Vertical)

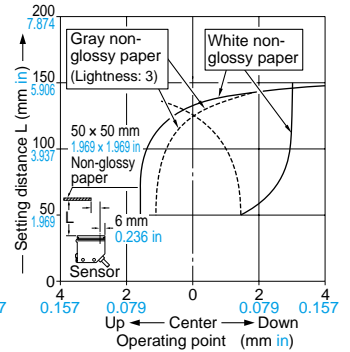

- Setting distance: 150 mm  
5.906 in with slit mask  
(Horizontal)

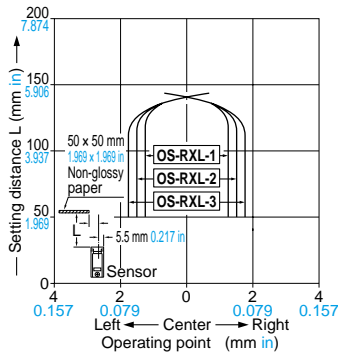

- Setting distance: 150 mm  
5.906 in with slit mask  
(Vertical)

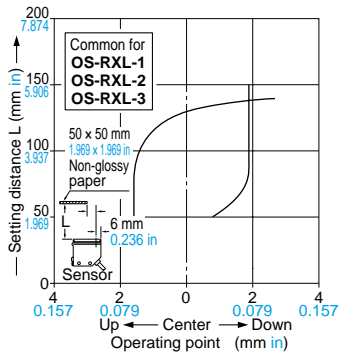
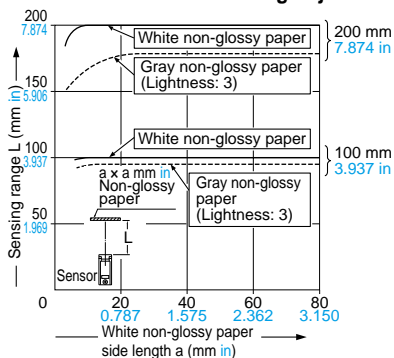
**Correlation between sensing object size and sensing range**

These curves show the characteristics with the maximum sensing range set to 100 mm 3.937 in, 200 mm 7.874 in, each, with white non-glossy paper (50 x 50 mm 1.969 x 1.969 in).

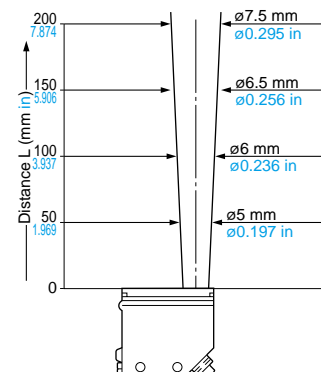
**Emitted beam**

FIBER SENSORS

LASER SENSORS

PHOTO-ELECTRIC SENSORS

MICRO PHOTO-ELECTRIC SENSORS

AREA SENSORS

SAFETY LIGHT CURTAINS/ SAFETY COMPONENTS

PRESSURE / FLOW SENSORS

INDUCTIVE PROXIMITY SENSORS

PARTICULAR USE SENSORS

SENSOR OPTIONS

SIMPLE WIRE-SAVING UNITS

WIRE-SAVING SYSTEMS

MEASUREMENT SENSORS

STATIC CONTROL DEVICES

LASER MARKERS

PLC

HUMAN MACHINE INTERFACES

ENERGY MANAGEMENT SOLUTIONS

FA COMPONENTS

MACHINE VISION SYSTEMS

UV CURING SYSTEMS

Selection Guide

Amplifier Built-in

Power Supply Built-in

Amplifier-separated

EX-Z

CX-400

CY-100

EX-10

EX-20

EX-30

EX-40

CX-440

EQ-30

EQ-500

MQ-W

RX-LS200

RX

RT-610

## SENSING CHARACTERISTICS (TYPICAL)

Correlation between material (50 × 50 mm 1.969 × 1.969 in) and sensing range

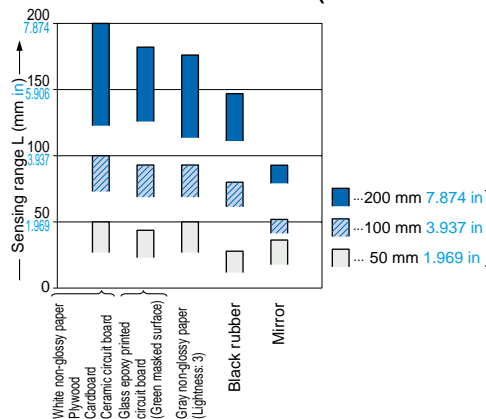

These bars indicate the sensing range with respective objects when the distance adjuster is set at the sensing range of 200 mm 7.874 in, 100 mm 3.937 in and 50 mm 1.969 in long, each, with white non-glossy paper.

## PRECAUTIONS FOR PROPER USE

Refer to p.1552~ for general precautions.



- Never use this product as a sensing device for personnel protection.
- In case of using sensing devices for personnel protection, use products which meet laws and standards, such as OSHA, ANSI or IEC etc., for personnel protection applicable in each region or country.

- If a specular body is present in the background, wrong operation may be caused due to a small change in the angle of the background body. In that case, install the sensor at an inclination and confirm the operation with the actual sensing object.
- Do not install the sensor at a distance of less than 50 mm 1.969 in from the object because the sensing is unstable in this range.

### Mounting

- The tightening torque should be 1.17 N·m or less.

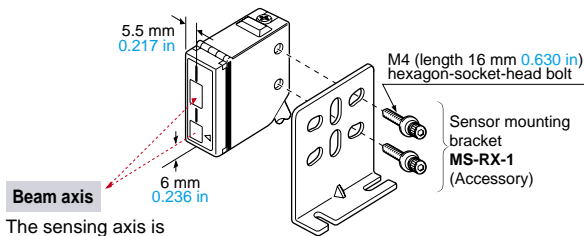

**Beam axis**  
The sensing axis is positioned at the intersection of the "Δ" mark on the lens face and the "I" line.

- Care must be taken regarding the sensor mounting direction with respect to the object's direction of movement.

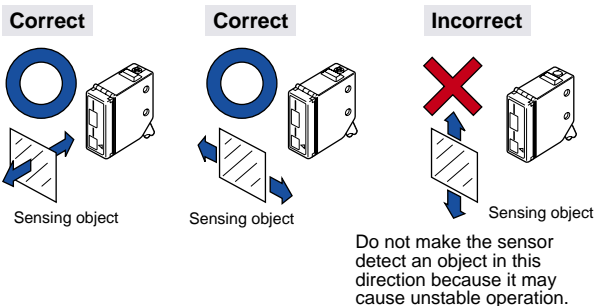

- When detecting a specular object (aluminum or copper foil) or an object having a glossy surface or coating, please take care that there are cases when the object may not be detected due to a small change in angle, wrinkles on the object surface, etc.
- When a specular body is present below the sensor, use the sensor by tilting it slightly upwards to avoid wrong operation.

### Wiring

- The output of **RX-LS200-P** does not incorporate a short-circuit protection circuit. Do not connect it directly to a power supply or a capacitive load.

### Use conditions to comply with CE Marking

- Following work must be done in case of using this product as a CE marking (European standard EMC Directive) conforming product.

Ensure that the shield is connected to 0 V or the actual ground.

- In case of connecting a sensor to power supply 0 V by using a shield (piping, etc.)

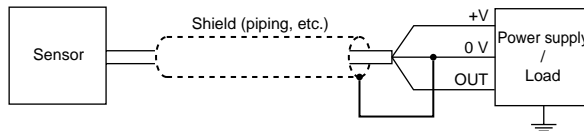

Note: The shield (piping, etc.) must be insulated.

- In case of grounding by using a shield (piping, etc.)

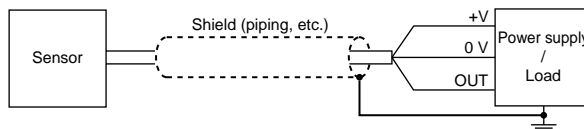

### Others

- Do not use during the initial transient time (50 ms) after the power supply is switched on.

**PRECAUTIONS FOR PROPER USE**

Refer to p.1552~ for general precautions.

**Distance adjustment**

**Adjusters**

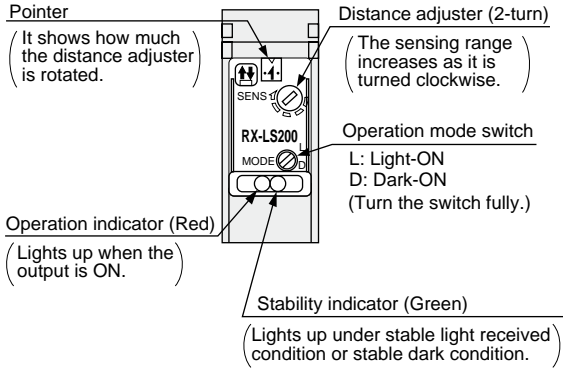

**Adjusting procedure**

**<When a sensing object moves horizontally to the sensor>**

Step	Description	Distance adjuster
①	Turn the distance adjuster fully counterclockwise to the minimum sensing range position (50 mm 1.969 in approx.). (Do not turn excessively.)	
②	Place an object at the required distance from the sensor, turn the distance adjuster gradually clockwise, and find out point "A" where the sensor changes to the light received condition.	
③	Remove the object, turn the distance adjuster further clockwise, and find out point "B" where the sensor changes to the light received condition again with only the background. (When the sensor does not go to the light received condition even if the adjuster is fully turned clockwise, point "B" is this extreme point.)	
④	The optimum position to stably detect objects is the center point between "A" and "B".	

**<When a sensing object is approaching / moving away from the sensor>**

- Follow only steps ① and ② respectively. Since the sensing point may change depending on the sensing object, be sure to check the operation with the actual sensing object.

**DIMENSIONS (Unit: mm in)**

The CAD data can be downloaded from our website.

**RX-LS200 RX-LS200-P Sensor**

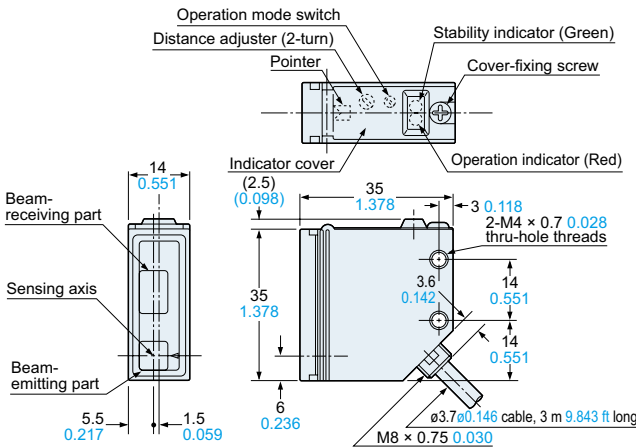

**PT-RX500 PT-RX1000 Protective tube (Optional)**

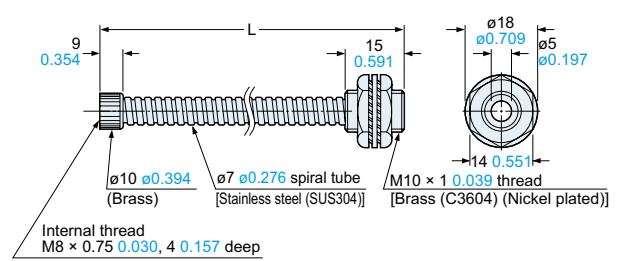

• Length L

Model No.	Length L
<b>PT-RX500</b>	500 <sup>+10</sup> <sub>0</sub> 19.685 <sup>+0.394</sup> <sub>0</sub>
<b>PT-RX1000</b>	1,000 <sup>+10</sup> <sub>0</sub> 39.370 <sup>+0.394</sup> <sub>0</sub>

**MS-RX-1**

**Sensor mounting bracket (Accessory)**

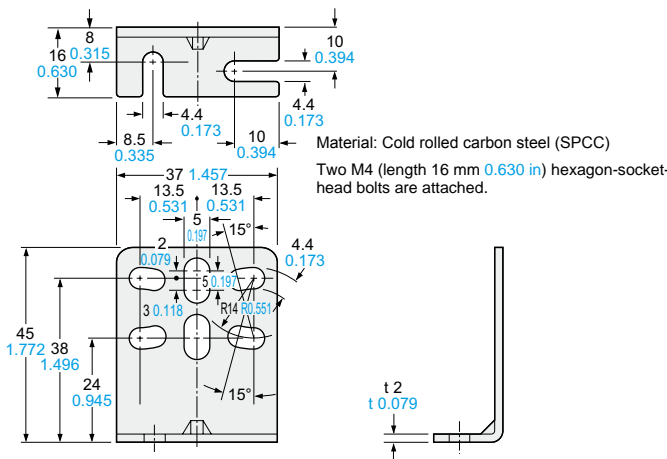

**Assembly dimensions**

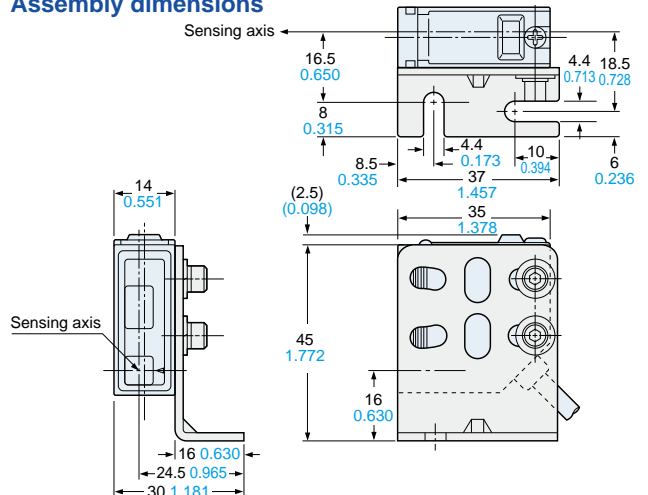

FIBER SENSORS  
LASER SENSORS  
PHOTO-ELECTRIC SENSORS  
MICRO PHOTO-ELECTRIC SENSORS  
AREA SENSORS  
SAFETY LIGHT CURTAINS / SAFETY COMPONENTS  
PRESSURE / FLOW SENSORS  
INDUCTIVE PROXIMITY SENSORS  
PARTICULAR USE SENSORS  
SENSOR OPTIONS  
SIMPLE WIRE-SAVING UNITS  
WIRE-SAVING SYSTEMS  
MEASUREMENT SENSORS  
STATIC CONTROL DEVICES  
LASER MARKERS  
PLC  
HUMAN MACHINE INTERFACES  
ENERGY MANAGEMENT SOLUTIONS  
FA COMPONENTS  
MACHINE VISION SYSTEMS  
UV CURING SYSTEMS  
Selection Guide  
Amplifier Built-in  
Power Supply Built-in  
Amplifier-separated  
EX-Z  
CX-400  
CY-100  
EX-10  
EX-20  
EX-30  
EX-40  
CX-440  
EQ-30  
EQ-500  
MQ-W  
RX-LS200  
RX  
RT-610