

# › GNR Mini Series

## Solid State Relays

### DIN Rail - AC Output Single Phase

- › Output Current of 4 Amps
- › Output Voltage of 12-275 V $\sim$  & 12-460 V $\sim$
- › Control Voltage of 6-30 V $\overline{\text{---}}$ , 12-30 V $\sim$  / 8.5-30 V $\overline{\text{---}}$
- › DIN Mount SSR
- › Special Zero Cross Switching
- › CE and UKCA Compliance
- › Built-in Output Overvoltage Protection



GNR Mini

#### Product Selection - Special Zero Cross (Resistive, Capacitive and Inductive Loads)

Rated Load Current	4A	
Output Voltage	12-275 V $\sim$	12-460 V $\sim$
Control Voltage		
6-30 V $\overline{\text{---}}$	<b>GNRM4D2A</b>	
12-30 V $\sim$ / 8.5-30 V $\overline{\text{---}}$		<b>GNRM4B1B</b>

#### Part Number System

GNR Mini Series

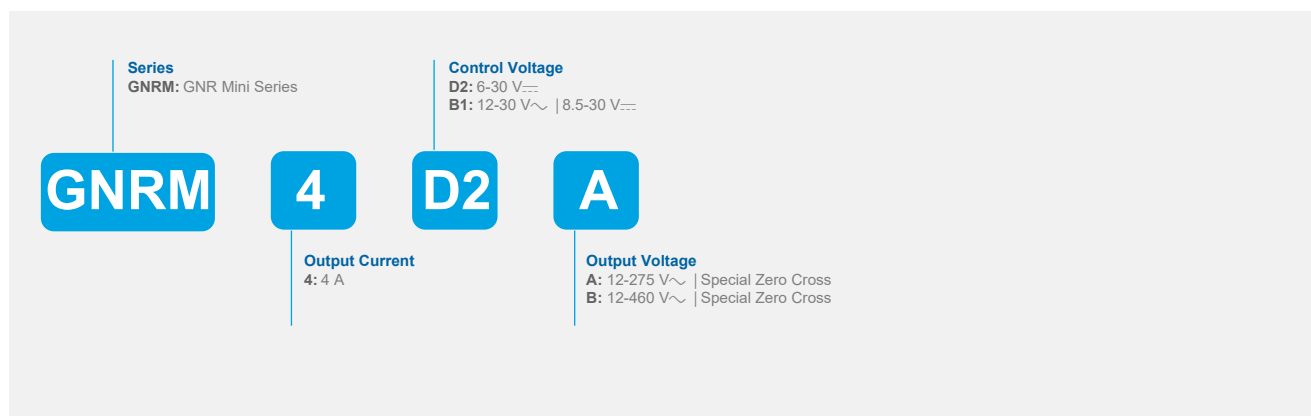

Do you need an adapted or customized solution? Contact us on [www.crouzet.com](http://www.crouzet.com)

#### Description:

Crouzet Solid State Relays are designed to be used in almost any application, offering very long life expectancy and are easy to install, easy to use, robust and multipurpose.

For more information about Crouzet's Solid State relays, please visit [www.crouzet.com](http://www.crouzet.com).

Output Characteristics <sup>(1)</sup>		
Description	4A	
Part Numbers	GNRM4D2A	GNRM4B1B
Maximum Load Current @ Ta=30 °C [Arms]	4A	
Minimum Load Current [mArms]	1	
1 Second surge current @ Ta=25 °C, 50/60 Hz [Apeak]	18	
Maximum 1 Cycle Surge Current (50/60Hz) [Apeak]	105	
Maximum On-State Voltage Drop @ Rated Current [Vpeak]	1.01	
Thermal Resistance Junction to Case (Rjc) [°C/W]	1.5	
Maximum 1/2 Cycle I <sup>2</sup> t for Fusing (50/60Hz) [A <sup>2</sup> sec] min/typ	55	
Minimum Heat Sink for Rated Current @ 40 °C [°C/W]	No heatsink but nominal load current = 3.5 A	
Operating Voltage Range (47-63Hz) [Vrms]	12-275	12-460
Operating Voltage [Vrms]	230	400
Transient Voltage (Clamping Voltage) [Vpeak] <sup>(2)</sup>	600 (430)	800 (720)
Maximum Off-State Leakage Current @ Rated Voltage [mArms]	0.3	0.1
Minimum Off-State dv/dt @ Maximum Rated Voltage [V/μsec]	500	
Minimum Power Factor	0.45	

Input Characteristics <sup>(1)</sup>		
Control Voltage Range	6-30 V $\overline{\text{---}}$	12-30 V $\sim$ / 8.5-30 V $\overline{\text{---}}$
Part Numbers	GNRM4D2A	GNRM4B1B
Maximum Reverse Voltage	-30 V $\overline{\text{---}}$	-30 V $\sim$
Minimum Turn-On Voltage	6 V $\overline{\text{---}}$	12 V $\sim$ 8.5 V $\overline{\text{---}}$
Must Turn-Off Voltage	0.8 V $\overline{\text{---}}$	2 V $\overline{\text{---}}$
Minimum Input Current (for on-state) [mA]	3	
Maximum Input Current [mA]	30	15
Nominal Input Impedance [Ohms]	1000	1800
Maximum Turn-On Time [msec]	10	
Maximum Turn-Off Time [msec]	10	

General Characteristics		
Description	4A	
Part Numbers	GNRM4D2A	GNRM4B1B
Dielectric Strength, Input to Output (50/60 Hz) [V]	4000	
Minimum Insulation Resistance (@ 500 V $\overline{\text{---}}$ ) [Ohms]	10 <sup>9</sup>	
Maximum Capacitance, Input/Output [pF]	8	
Ambient Operating Temperature Range [°C] <sup>(7)</sup>	-40 to 80	
Ambient Storage Temperature Range [°C]	-40 to 100	
Weight (typical) [g]	38	
Housing Material	UL94 V-0	
Input Terminal Screw Torque Range [in-lb/Nm]	3-5/0.4-0.5	
Load Terminal Screw Torque Range [in-lb/Nm]	3-5/0.4-0.5	
Humidity per IEC60068-2-78 [%]	40-85	
LED Input Status Indicator	Green	
MTBF (Mean Time Between Failures) at 40 °C ambient temperature [years] <sup>(8)</sup>	85	
MTBF (Mean Time Between Failures) at 60 °C ambient temperature [years] <sup>(8)</sup>	69	
MTTFd [years]	188	

General Notes	
(1)	All parameters at 25 °C unless otherwise specified
(2)	Output will self trigger between 450-600 Vpk not suitable for capacitive loads
(7)	AC models operating range is -20 to 80 °C
(8)	All parameters at 50 % power rating and 100 % duty cycle (contact tech support for detailed report)

## Diagrams

### Wiring

GNR Mini Series

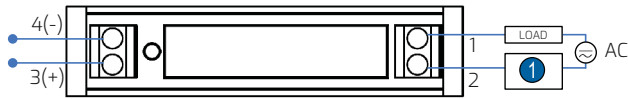

Recommended Wire Size

TERMINALS	WIRE SIZE		Terminal Screw Torque (N.m)
	SOLID	STRANDED	
Input	12 AWG (4 mm <sup>2</sup> )	14 AWG (2.5 mm <sup>2</sup> )	0.4 - 0.5
Output	12 AWG (4 mm <sup>2</sup> )	14 AWG (2.5 mm <sup>2</sup> )	0.4 - 0.5

1 Protection Equipment: Short circuit protection

## Diagrams

### Equivalent Circuit Block

**GNRM4D2A**, GNR Mini Serie 6-30 V<sub>DC</sub> control; 12-275 V<sub>AC</sub> - Special Zero Cross (Resistive, Capacitive and Inductive Loads)

Input Current vs Input Voltage  
Standard Regulated DC inputs

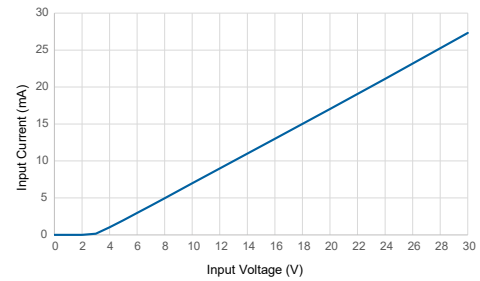
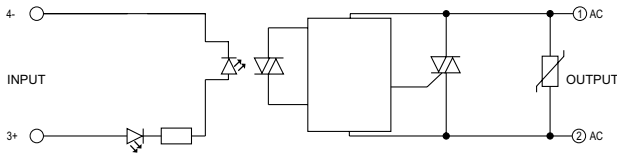

**GNRM4B1B**, GNR Mini Serie 12-30 V~/8.5-30 V~ control; 12-460 V~ output - Special Zero Cross (Resistive, Capacitive and Inductive Loads)

Input Current vs Input Voltage  
Standard Regulated DC inputs

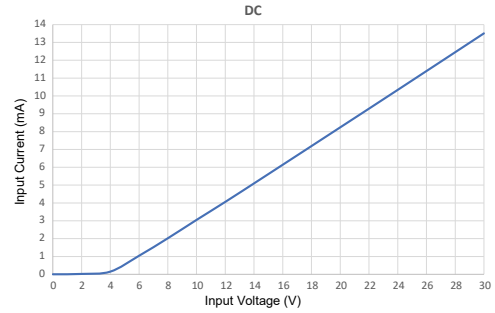
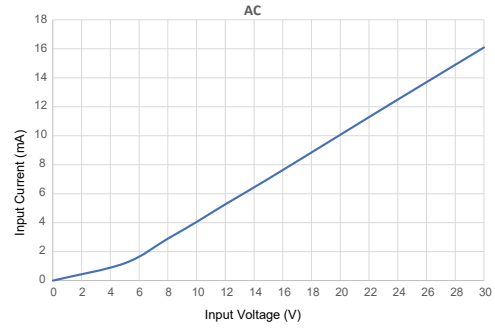
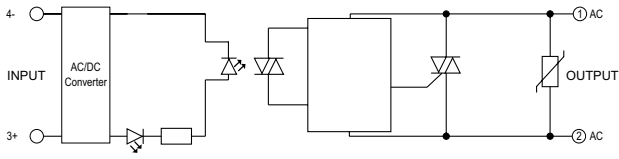

Diagrams

Dimensions (mm)

GNR Mini Series

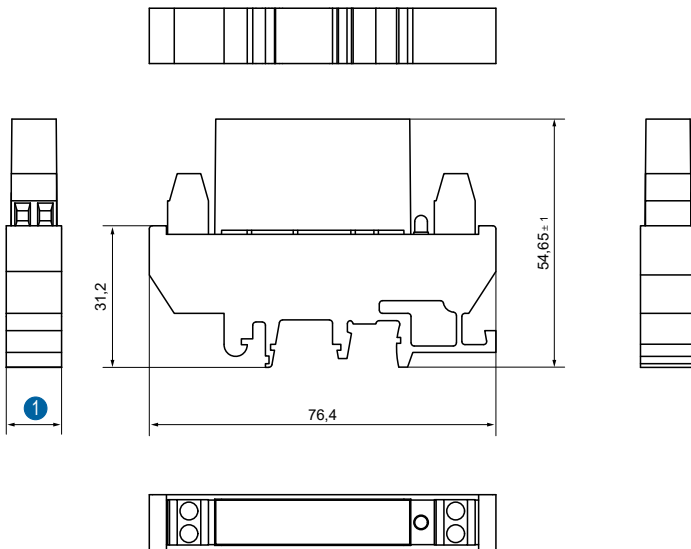

① GNRM4D2A: 12.2 mm - GNRM4B1B: 17.2 mm

## Curves

### Thermal Derating Curves

#### GNR Mini Series

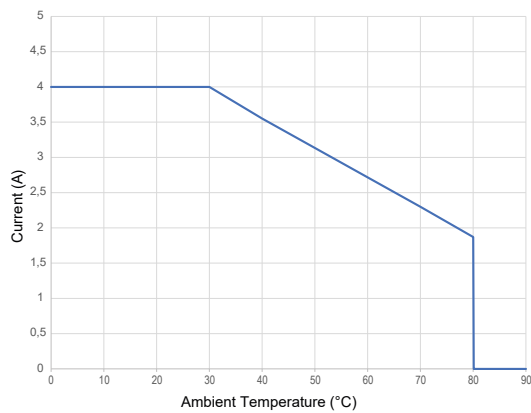

### Standards & Electromagnetic Compatibility Specification

EN61000-4-4 Immunity to fast transients / bursts

EN61000-4-5 Immunity to surges

#### Standards



#### Warning:

The product information contained in this catalogue is given purely as information and does not constitute a representation, warranty or any form of contractual commitment. Crouzet and its subsidiaries reserve the right to modify their products without notice. It is imperative that we should be consulted over any particular use or application of our products and it is the responsibility of the buyer to establish, particularly through all the appropriate tests, that the product is suitable for the use or application. Under no circumstances will our warranty apply, nor shall we be held responsible for any application (such as any modification, addition, deletion, use in conjunction with other electrical or electronic components, circuits or assemblies, or any other unsuitable material or substance) which has not been expressly agreed by us prior to the sale of our products.