

CIM24-Clip 24 x 48 Clip no reset Part number 99777815



- 5 or 6 digits, height of digits 4 mm
- With or without manual reset
- White digits on a black background

Part numbers

Type	Number of digits	Operating frequency (Hz)	Voltages
99777815 24 x 48 Clip no reset	6	VDC	12 VDC

Specifications

General characteristics

Counting capacity	999,999 impulses without manual reset 99,999 impulses with manual reset
Height digits (mm)	4
Max. count rate	VAC→10 impulses/s VDC→10 impulses/s
Min. count rate	VAC→50 ms VDC→50 ms
Min pause time between 2 pulses	VAC→50 ms VDC→50 ms
Max. pulse length (count coil)	Unlimited
Voltage variation	12/24 VDC : ± 10 % VAC : ± 10 %
Consumption	24 VAC : 0,75 VA 230 VAC : 1,5 VA 12/24 VDC : 0,5 W
Mechanical life count function (operations)	> 50 x 10 ⁶
Test voltage according to standard IEC 255-5	U < 60 V : 500 V U > 60 V : 2 000 V
Protection Housing	IP40
Degree of terminal protection	IP00
Environmental protection	Plated or stainless steel components
Maintenance	None
Operating position	Any
Temperature limits use (°C)	- 10 →+50
Temperature limits stored (°C)	- 40 →+80
Certifications	CE
Connection	6.35 Faston connectors or screw terminals
Mounting	With clip
Weight (g)	65

Accessories

Description	Code
Adaptor for 50 x 25 mm cut-out - Fixed with screws	26546843
Adaptor for 50 x 25 mm cut-out - Fixed with clips	26546844
Adaptor for 48 x 48 mm cut-out	26546849

Dimensions (mm)

9977771/81 - 6 digits

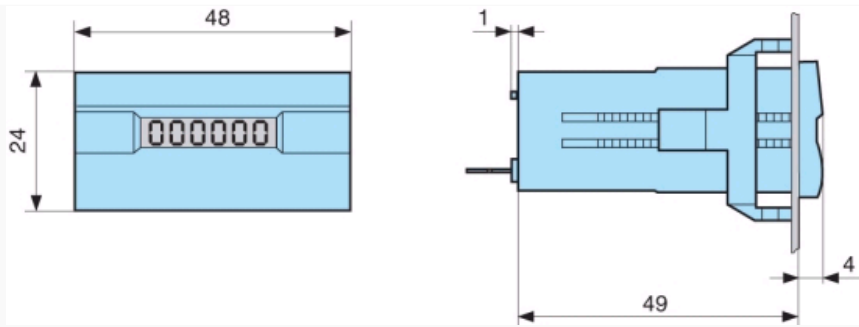

Dimensions (mm)

Panel cut-out

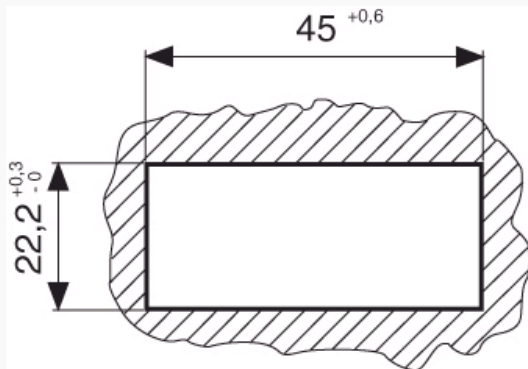

Dimensions (mm)

26546844 - Adaptor for 50 x 25 mm cut-out

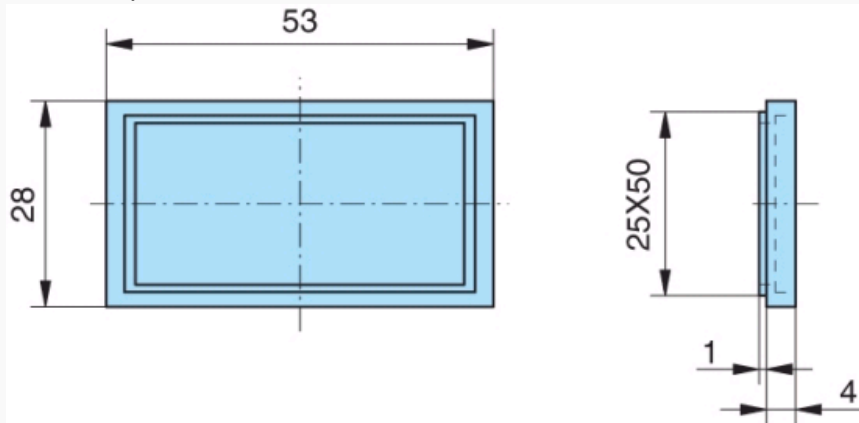

Dimensions (mm)

26546843 - Adaptor for 50 x 25 mm cut-out

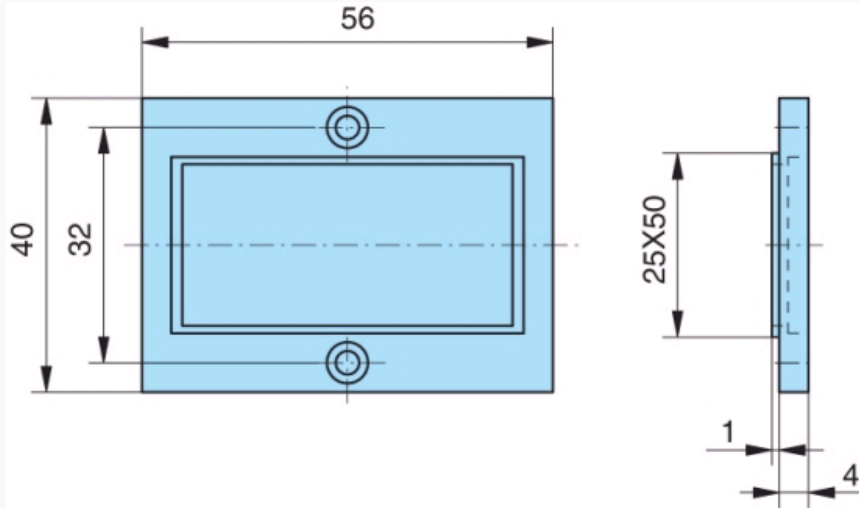

Dimensions (mm)

26546849 - Adaptor for 45 x 45 mm cut-out

