

## CIM36x37-Screw 36 x 37 Screw no reset Part number 99776601



- 5 or 6 digits, height of digits 4 mm
- With or without manual reset
- White digits on a black background

### Part numbers

Type	Number of digits	Operating frequency (Hz)	Voltages
99776601 36 x 37 Screw no reset	6	50 / 60	230 VAC

### Specifications

#### General characteristics

Counting capacity	999,999 impulses without manual reset 99,999 impulses with manual reset
Height digits (mm)	4
Max. count rate	VAC→18 impulses/s VDC→25 impulses/s
Min. count rate	VAC→28 ms VDC→20 ms
Min pause time between 2 pulses	VAC→28 ms VDC→20 ms
Max. pulse length (count coil)	Unlimited
Voltage variation	+ 10 % / -15 % Un
Consumption	24 VAC / 115 VAC : 1,1 VA 230 VAC : 2,1 VA 110 VDC : 1 W 24 VDC : 0,8 W
Mechanical life count function (operations)	> 50 x 10 <sup>6</sup>
Test voltage according to standard IEC 255-5	U < 60 V : 500 V U > 60 V : 2 000 V
Protection Housing	IP40
Degree of terminal protection	IP00
Environmental protection	Plated or stainless steel components
Maintenance	None
Operating position	Any
Temperature limits use (°C)	- 10 →+60
Temperature limits stored (°C)	- 40 →+80
Certifications	CE
Connection	6.35 Faston connectors or screw terminals
Mounting	2 x 2.5 Ø screws - F90° on front face
Weight (g)	50

### Dimensions (mm)

#### 9977660 - 6 digits

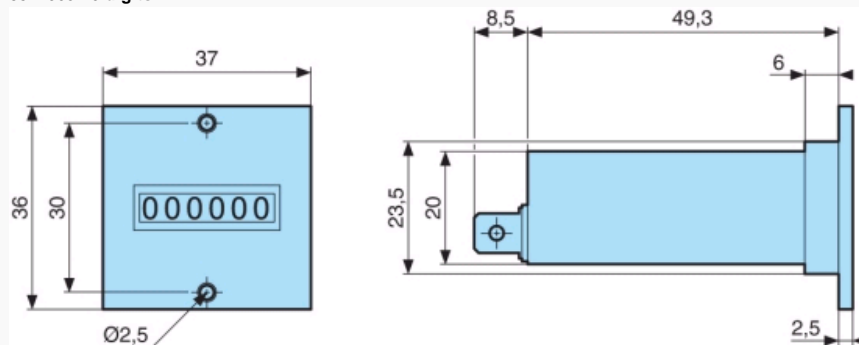

### Dimensions (mm)

#### 9977660 - Rear faces

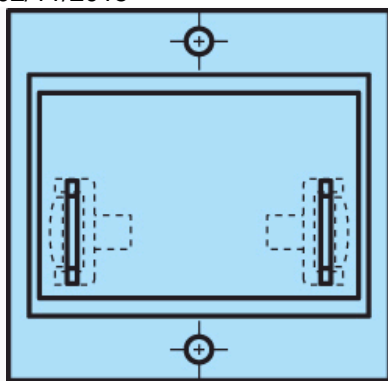

Dimensions (mm)

Panel cut-out

