

# SUBMINIATURE MICROSWITCHES - SEALED

## V4S - 8318

- › Coil spring snap-action mechanism
- › Wire lead or cable outputs, various terminal types with symmetric or asymmetric pinning
- › Excellent resistance to harsh environments - IP67/IP69 protection
- › Ratings from 1 mA 4V<sub>DC</sub> to 10 A 250V<sub>AC</sub>
- › Suitable for lateral approach from any direction with angle up to 35°
- › Operating temperature -40 °C up to +125 °C
- › Long mechanical life
- › Wide choice of actuators on 2 possible fixing positions (pre-assembled or retrofittable)



### Main specifications

		Standard 83186	High current 83180	Medium current 83183	Dual-current 83181
Function	Connections				
I (changeover)	W2S (solder)	83186001	83180001	83183001	83181001
I (changeover)	W7S (QC 2.8x0.5)	83186002	83180002	83183002	83181002
I (changeover)	FD0 (wires, right)	83186003	83180003	83183003	83181003
I (changeover)	FG0 (wires, left)	83186004	83180004	83183004	83181004
I (changeover)	FB0 (wires, bottom)	83186005	83180005	83183005	83181005
I (changeover)	X1S (PCB, straight, sym)	83186006	83180006	●	83181006
I (changeover)	X1A (PCB, straight, asym)	●	●	●	83181007
I (changeover)	X2S (PCB, rear, sym)	●	●	●	83181008
I (changeover)	X2A (PCB, rear, asym)	●	●	●	83181009
I (changeover)	X3S (PCB, front, sym)	●	●	●	83181010
I (changeover)	X3A (PCB, front, asym)	●	●	●	83181011
I (changeover)	CD0 (cable, right)	83186012	-	83183012	83181012
I (changeover)	CG0 (cable, left)	83186013	-	83183013	83181013
I (changeover)	CB0 (cable, bottom)	83186014	-	83183014	83181014
R (normally closed)	W2S - W7S - FD0 - FG0 - FB0 - CD0** - CG0** - CB0**	831866*	831806*	831836*	831816*
C (normally open)	W2S - W7S - FD0 - FG0 - FB0 - CD0** - CG0** - CB0**	831868*	831808*	831838*	831818*
Electrical characteristics					
Rating nominal / 250 V AC (A)		6	10	3	6***
Rating thermal / 250 V AC (A)		7.5	12.5	4	7.5
Mechanical characteristics					
Maximum operating force (N)		2.5	2.5	2.5	2.5
Min. Release force (N)		0.8	0.8	0.8	0.8
Maximum total travel force (N)		4.2	4.2	4.2	4.2
Max. Allowable overtravel force (N)		10	10	10	10
Maximum rest position (mm)		9.3	9.3	9.3	9.3
Operating position (mm)		8.4 ±0.3	8.4 ±0.3	8.4 ±0.3	8.4 ±0.3
Maximum differential travel (mm)		0.15	0.15	0.15	0.15
Min. overtravel (mm)		0.6	0.6	0.6	0.6
Ambient operating temperature - terminal versions (°C)		-40 → +125	-40 → +125	-40 → +125	-40 → +125
Ambient operating temperature - wire/cable versions (°C)		-40 → +105	-40 → +105	-40 → +105	-40 → +105
Mechanical life (operations)		2x10 <sup>6</sup>	2x10 <sup>6</sup>	2x10 <sup>6</sup>	2x10 <sup>6</sup>
Contact gap (mm)		0.4	0.4	0.4	0.4
Weight (terminal versions) g		2	2	2	2

\* Contact us \*\* Except 83180

### Additional specifications

- Case: PBT GF (UL 94-V0 / GWFI 960 °C)
- Button: PBT
- Membrane: silicone rubber
- Moving blade: silver-plated beryllium copper
- Contacts: silver cadmium oxide, micro-profile gold alloy on silver alloy, crossbar (dual-current)
- Terminals: silver-plated brass, tinned brass
- Wire leads, Cable: copper, PVC insulated
- Levers: stainless steel or plastic, polyamide roller
- Degree of protection: IP67/IP69 (mechanism and wire/cable output)
- Proof tracking index: PTI 250
- Protection against electric shock: button and actuators have reinforced insulation for Ui 250V / Uimp 2.5kV / pollution 2
- Recommended min actuating speed: 0.01 mm/s
- Certification marks: on request /

### Product adaptations

- › Specific fixings: special fastening pins, easy installation / snap-in housings
- › Special actuators: stainless steel or plastic, flexible levers, reinforced fixing, tear-off protection, inox roller...
- › Special leads and cables, leads in sleeve, full wiring with custom connector
- › Integration of resistors for specific electrical diagrams or self-diagnosis function
- › Reduced differential travel: max 0.10 mm (SF1114)
- › Long overtravel variant (2 mm), suitable for lateral approach up to 45°, wire or cable output (8320 SF1002)
- › cURus and NF approved versions



Standard product

Product made to order

● Contact us

## Principles

Single break snap-action switch  
Changeover - SPDT (form C)

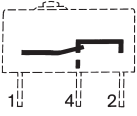

Normally closed - SPST-NC (form B)

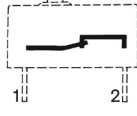

Normally open - SPST-NO (form A)

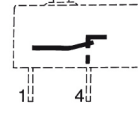

## Curves

Operating curve for 250 VAC

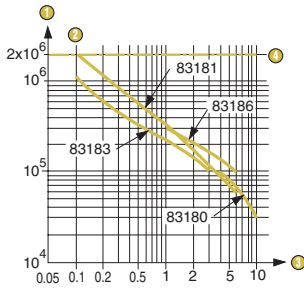

Max ratings with DC supply

		83180	83181	83183	83186
12 V	Resistive	10 A	6 A	3 A	6 A
	Inductive L/R 5 ms	10 A	6 A	3 A	6 A
24 V	Resistive	10 A	6 A	3 A	6 A
	Inductive L/R 5 ms	5 A	5 A	3 A	5 A

- ① Number of cycles
- ② Resistive circuit
- ③ Current in Amperes
- ④ Mechanical life limit

\*\*\* Model 83181 is designed to operate equally well on low current (1 mA 4 V minimum recommended) or medium-current (6 A maximum) circuits. However, a given product should only be used to switch one type of circuit during its working life.

## Dimensions

### Products

8318  
Symmetrical version

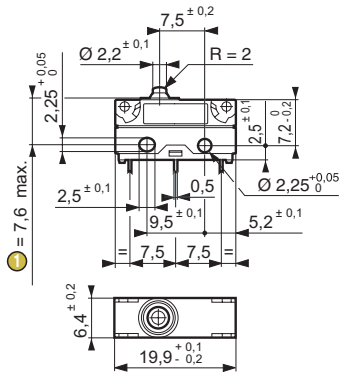

① Total travel position

Fixing with M2 screws

Recommended tightening torques: - screw only: 0.2 N.m  
- screw with washer: 0.3 N.m

8318  
Asymmetrical version (X.A connections)

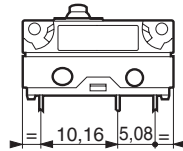

### Recommendations for lateral approach

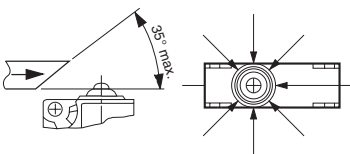

In order to reduce friction and wear, the actuating ramp shall preferably be of POM, PA, or steel, and also be as smooth as possible. As a general rule, the use of any lubricant substance is not needed nor recommended. For particular cases, please consult us.

## Connections

### W2S solder

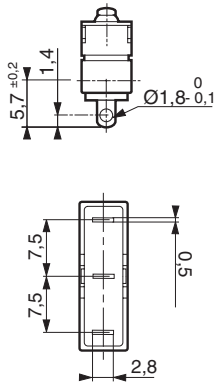

### W7S quick-connect 2.8 x 0.5

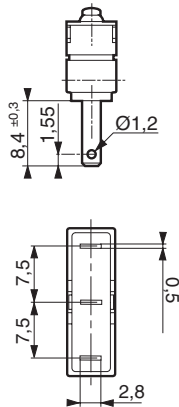

### X1A for PCB asymmetrical, straight output X1S for PCB symmetrical, straight output

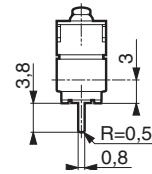

### X2A for PCB asymmetrical, rear output X2S for PCB symmetrical, rear output

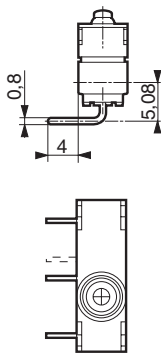

### X3A for PCB asymmetrical, front output X3S for PCB symmetrical, front output

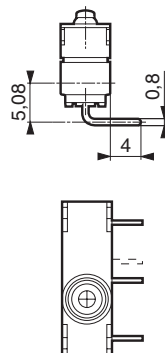

### FD0 wire output on right FG0 wire output on left

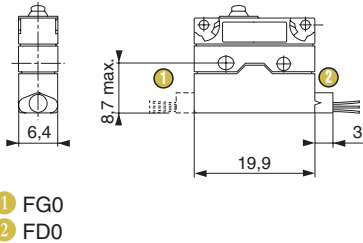

### CD0 cable output on right CG0 cable output on left

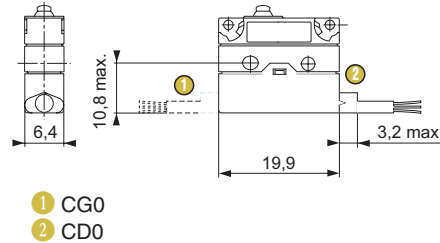

### FB0 wire output on bottom CB0 cable output on bottom

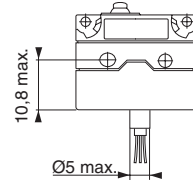

Wire/Cable characteristics: Black = Common, Grey = NC, Blue = NO ; except cable for NC or NO versions = Blue - Brown  
 Wire cross-section: 83181 / 83183 / 83186 = 0.5 mm<sup>2</sup> - 83180 = 0.75 mm<sup>2</sup>  
 Cable cross-section: 83181 / 83183 / 83186 = 3 x 0.5 mm<sup>2</sup> or 2 x 0.5mm<sup>2</sup>  
 Standard length: 500 mm (other lengths on request)

## Drilling

### Printed circuit board mounting Asymmetrical X1A, X2A, X3A

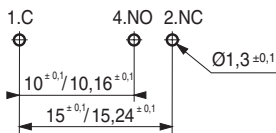

### Printed circuit board mounting Symmetrical X1S, X2S, X3S

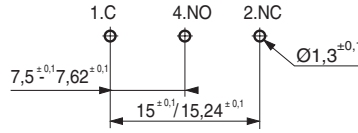

### Mounting on a printed circuit board with fixing pins Asymmetrical

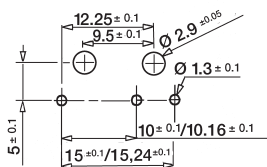

### Mounting on a printed circuit board with fixing pins Symmetrical

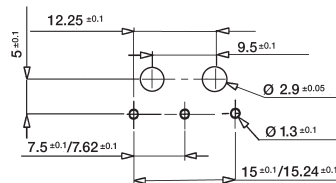

## Actuator mounting positions

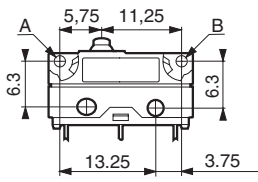

**To calculate force:** divide the switch force by the coefficient in the table  
**To calculate travel:** multiply the switch travel by the same coefficient

## Actuators

170A flat

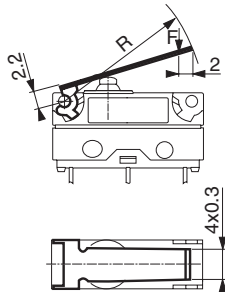

170D adjustable

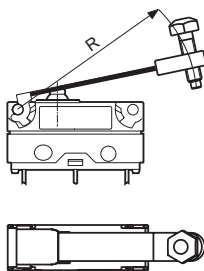

79257876 plastic

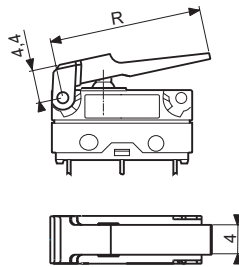

170E roller

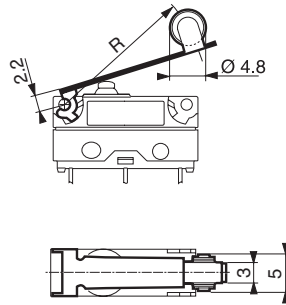

170EL transverse roller

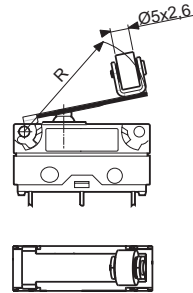

Other shapes and dimensions:  
consult us

170F dummy roller

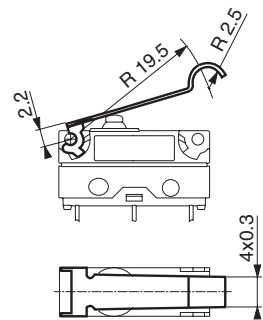

79250004 folded

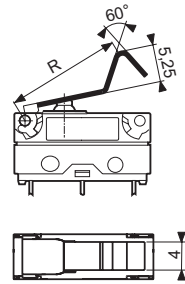

## Mounting accessories

Locating pins 79219682

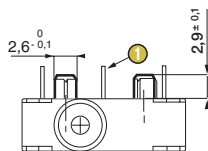

① X2S-X2A connections

Locating pins 79219682

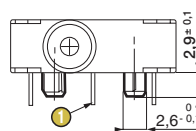





① X3S-X3A connections





Other shapes and dimensions:  
consult us

## Actuators and mounting accessories

### Part numbers for standard actuators

	79253327		79253326		79253328		79218454		79253329	
Actuators	Flat 170A R18.3		Flat 170A R24		Flat 170A R41		Roller 170E R20		Dummy roller 170F R19,5	
										
Fixing positions	A	B	A	B	A	B	A	B	A	B
Coefficient	3	1.5	4	2	7	3,5	3	1.5	3	1.5
Operating position (mm)	10 ±1	9,4 ±0,6	10,8 ±1,4	9,8 ±0,8	12,1 ±2,6	10,5 ±1,5	14,7 ±1,3	14,2 ±0,8	12,6 ±1,2	11,9 ±0,7

### Part numbers for standard actuators

	79218491		79218493		79250004		79257876	
Actuators	Adjustable 170D R26,5		Transverse roller 170EL R18		Folded R16,5		Plastic (PARA GF50) R20,5	
								
Fixing positions	A	B	A	B	A	B	A	B
Coefficient	4	2	3	1.5	2.5	1.2	3	-
Operating position (mm)	13,6-18,6 ±1,8	12,5-17,5 ±1,1	16,3 ±1,2	15,6 ±0,8	15 ±1	13,9 ±0,6	10,6 ±1,1	-

Except where otherwise indicated, levers are supplied unmounted. For factory mounting, specify fixing position A or B.

### V4S 8318 microswitches with referenced actuators

Actuators	170A R18.3		170A R24		170E R20		170F R19.5		Folded R16,5		
	79253327		79253326		79218454		79253329		79250004		
	Pos A	Pos B	Pos A	Pos B	Pos A	Pos B	Pos A	Pos B	Pos A	Pos B	
83186	I W2S	83186051	83186052	83186053	83186054	83186055	83186056	83186057	83186058	●	●
	I W7S	83186059	83186060	83186061	83186062	83186063	83186064	83186065	83186066	●	●
	I FD0	83186067	83186068	83186069	83186070	83186071	83186072	83186073	83186074	●	●
	I FG0	●	●	●	●	83186075	●	●	●	●	●
	I X1S	●	83186046	●	●	83186080	83186047	●	●	●	●
	I X2S	●	●	●	●	●	●	●	●	●	●
	I X3S	●	●	●	●	●	●	●	●	●	●
83181	I W2S	83181051	83181052	83181053	83181054	83181055	83181056	83181057	83181058	●	●
	I W7S	83181059	83181060	83181061	83181062	83181063	83181064	83181065	83181066	●	●
	I FD0	83181067	83181068	83181069	83181070	83181071	83181072	83181073	83181074	●	83181083
	I FG0	●	●	●	●	83181128	●	●	●	●	83181082
	I X1S	●	●	●	●	●	●	●	●	●	●
	I X2S	●	●	●	●	●	●	●	●	●	●
	I X3S	●	●	83181080	●	●	●	●	83181106	●	●

## Installation recommendations

See "Basic technical concepts"

## How to order

Use the 8 digit part numbers when they are defined

Other cases, precise:

Type of microswitch - Function - Connection - UL/NF approval\* - Actuator\* - Fixing position\* - Mounting accessories\* - Adaptation\*  
\* if needed

Example: 83186 I X2S UL/NF 170E R20 B 79219682

Standard product

Product made to order

● Contact us

## Examples of special adaptations



Easy installation / snap-in housing and special actuator with tear-off protection



Special housing with single fastening hole on upper face, for 4 mm blind rivet or screw



Fastening pins for 2.8 max thickness and Ø 4mm holes (79253576)

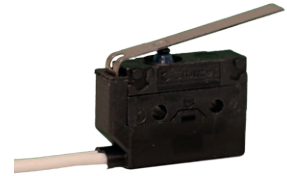

Flexible lever fitted on special housing with wire or cable output

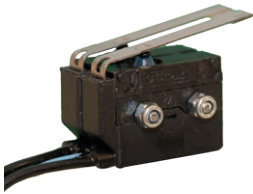

Two-pole assembly with linked levers



Custom bracket with integrated metal plungers and complete wiring with sealed connector



2 mm overtravel variant with wire lead output



Dual-lead wiring

### Warning:

The product information contained in this catalogue is given purely as information and does not constitute a representation, warranty or any form of contractual commitment. Crouzet Automatismes SAS and its subsidiaries reserve the right to modify their products without notice. It is imperative that we should be consulted over any particular use or application of our products and it is the responsibility of the buyer to establish, particularly through all the appropriate tests, that the product is suitable for the use or application. Under no circumstances will our warranty apply, nor shall we be held responsible for any application (such as any modification, addition, deletion, use in conjunction with other electrical or electronic components, circuits or assemblies, or any other unsuitable material or substance) which has not been expressly agreed by us prior to the sale of our products.