

Subminiature

→ 83 132 / 83 133 / 83 134



- Double break switching
- Choice of actuators for symmetrical mounting
- Options for operation in stable positions



Main specifications

		Side outputs 83 132 0	Rear outputs 83 133 0	Output on front face 83 134 0
Function	Connections			
I (changeover)	W2	83 132 030	83 133 035	-
I (changeover)	X1	-	●	●
Electrical characteristics				
Rating nominal / 250 V AC (A)		5	5	5
Rating thermal / 250 V AC (A)		11	11	11
Mechanical characteristics				
Maximum operating force (N)		1.6	1.6	1.6
Min. Release force (N)		0.4	0.4	0.4
Max. permitted overtravel force (N)		10	10	10
Rest position max. (mm)		8.45	8.45	8.10
Tripping point (mm)		7.7 ^{±0.2}	7.7 ^{±0.2}	7.35 ^{±0.25}
Maximum differential travel (mm)		0.45	0.45	0.45
Min. overtravel (mm)		0.27	0.27	0.27
Ambient operating temperature (°C)		-20 → +125	-20 → +125	-20 → +125
Mechanical life (operations)		10 ⁷	10 ⁷	10 ⁷
Contact gap (mm)		0.3 x 2	0.3 x 2	0.3 x 2
Weight (g)		1.8	1.8	1.8

Additional specifications

Components

Material

- Case : glass-filled polyamide
- Contacts : silver
- Cupro-nickel terminals

Lever

- Flat : stainless steel
- Roller : polyamide

Accessories : stainless steel

Product adaptations



- Special levers
- Reinforced spring
- Approvals : UL - cUL

Principles

Double break changeover switch



Curves

Operating curve for types 83 132 0 - 83 133 0 - 83 134 0

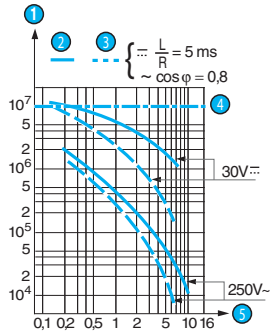

- ① Number of cycles
- ② Resistive circuit
- ③ Inductive circuit
- ④ Mechanical life limit
- ⑤ Current in Amps

Dimensions

→ Product

83 132 0

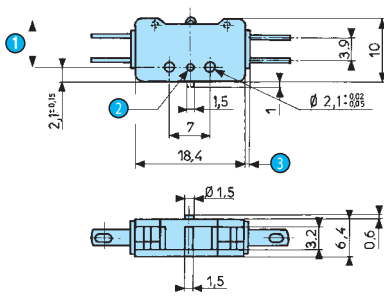

- ① OL = 7.4
- ② Ø1.5 depth 0.7
- ③ 2 plates 0.8

83 133 0

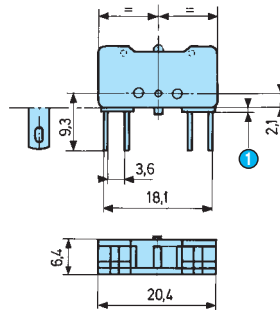

- ① 2 plates 0.8

83 134 0

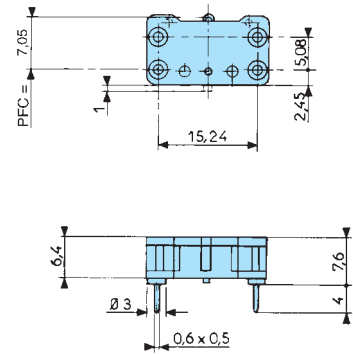

→ Connections

W2 solder (83 132 - 83 133)
tags can accept faston clips 2.8 x 0.5 mm

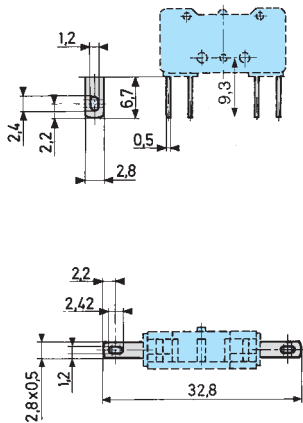

X1 for printed circuit boards (83 132 - 83 133)

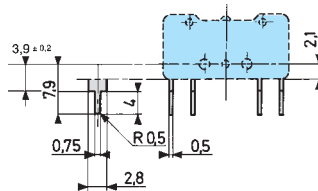

X1 for printed circuit board (83 134)

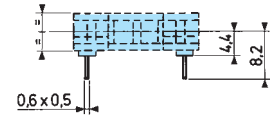

→ Actuators and fixing positions

54A

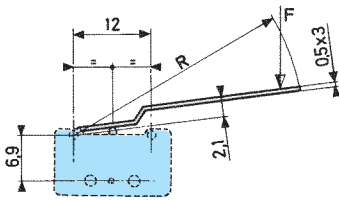

54B

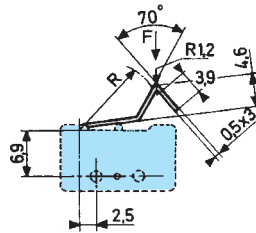

54E

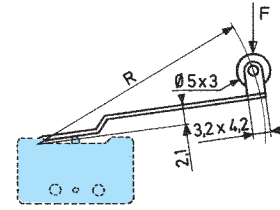

54A2

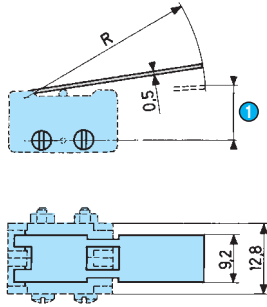

1 Tripping point

54A3

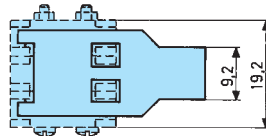

→ Mounting accessories

For 83 132 0 and 83 133 0

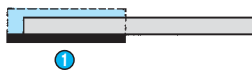





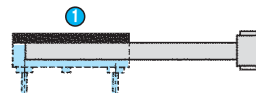

1 Cover

For 83 134 0

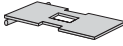
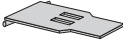

1 Cover

Actuators and fixing positions

Part numbers for standard actuators		70 514 175	70 514 194	70 514 181	70 514 182
Actuators		Plain 54A R14.75	Plain 54A R35.75	Tip-mounted in-line roller 54ER7.5	Tip-mounted in-line roller 54ER14.1
					
		83 132 0 83 133 0	83 132 0 83 133 0	83 132 0 83 133 0	83 132 0 83 133 0
Tripping point		9.5 ^{±0.8}	9.2 ^{±0.8}	14.2 ^{±0.3}	15.5 ^{±0.8}
Operating force max. N		0.8	0.34	1.6	0.8
Release force min. N		0.16	0.06	0.32	0.17
Pre-travel max. mm		2.15	5.15	1.1	2.05
Differential travel mm		1 ^{±0.3}	2.1 ^{±0.65}	0.5 ^{±0.15}	0.95 ^{±0.3}
Total travel max. mm		2.8	6.8	1.45	1.45
Actuators		54BR13.17	2-pole 54A2 F30	3-pole 54A3 F30	Side fixing plate (0.4 mm thick) 54Y
					
		83 132 0 83 133 0	83 132 0 83 133 0	83 132 0 83 133 0	
Tripping point		12.7 ^{±0.8}	8.8 ^{±0.8}	8.8 ^{±0.8}	
Operating force max. N		0.85	0.8	1.2	
Release force min. N		0.18	0.16	0.24	
Pre-travel max. mm		2.05	4.3	4.3	
Differential travel mm		0.95 ^{±0.3}	2 ^{±0.55}	2 ^{±0.55}	
Total travel max. mm		2.7	5.75	5.75	

Unless mentioned specifically, the levers are mounted in the position illustrated on the dimension diagrams (standard mounting). We recommend that these levers are assembled in our workshops.

Other information

Mounting - Operation
See basic technical concepts