

Protected

→ 83 109



- Double break switching
- Front connections
- Options for operation in stable positions
- Choice of actuators and fixing positions



Main specifications

		Outputs on front face 83 109 0
Function	Connections	
I (changeover)	W2	
R (normally closed)	W2	
C (normally open)	W2	
Electrical characteristics		
Rating nominal / 250 V AC (A)		5
Rating thermal / 250 V AC (A)		17.5
Mechanical characteristics		
Maximum operating force (N)		4
Min. Release force (N)		1
Tripping point (mm)		11.45 ^{+0.2 - 0.25}
Min. overtravel (mm)		0.7
Mechanical life (operations)		10 ⁷
Max. permitted overtravel force (N)		20
Rest position max. (mm)		12.75
differential travel (mm)		0.5 ^{-0.2}
Ambient operating temperature (°C)		- 40 → +85
Contact gap (mm)		0.4 x 2
Weight (g)		8

Additional specifications

Components

Material

- Case : polyamide UL94V2
- Contacts : nickel silver

Levers

- Mild steel (zinc)
- Roller : polyamide
- Adjusting screws : self-retaining
- Plates : iridescent passivated mild steel (zinc)

NB : Fixing holes for these microswitches have metal ferrules.

Product adaptations



- Special levers
- Reinforced spring
- Special contacts
- Approvals : UL - cUL

Principles

Double break changeover switch



Curves

Operating curve for type 83 109 0

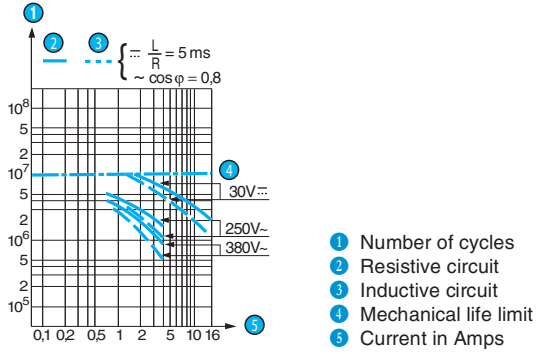

Dimensions

→ Product

83 109 0

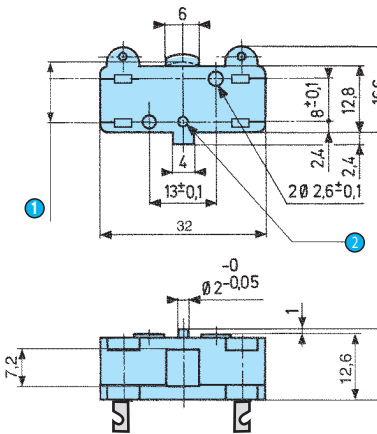

- 1 OL = 10.65
- 2 $\varnothing 2^{+0.01 +0.65}$ Depth 1.2

→ Connections

W2 solder

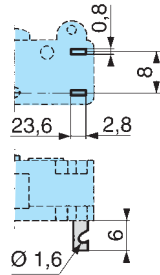

→ Actuators

A

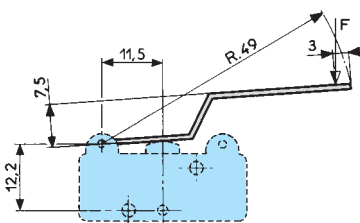

Lever cross-section 1 x 6.4 mm

B

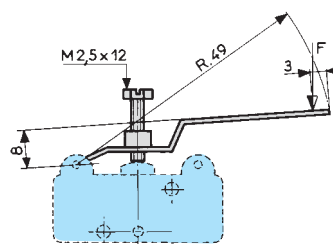

Lever cross-section 1 x 6.4 mm

E

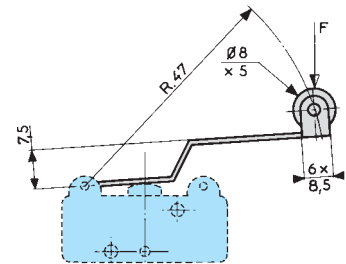

Lever cross-section 1 x 6.4 mm

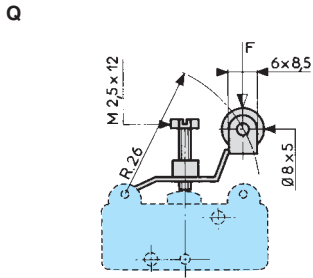

Lever cross-section 1 x 6.4 mm

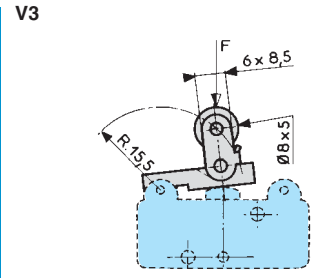
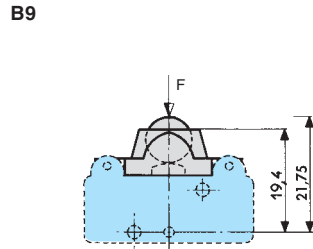

Lever cross-section 1 x 6.4 mm

→ Mounting accessories

O2
2-pole side mounting plate

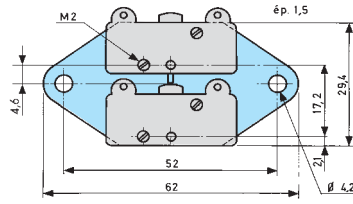

K2
2-pole vertical mounting plate

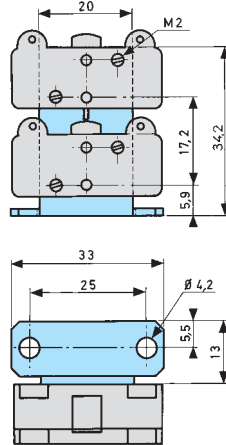

H
Horizontal single-pole mounting plate

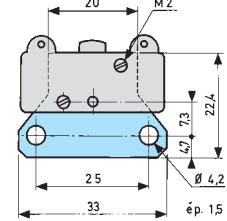

Unless indicated, the thickness of plates is 1.5 mm

Actuators and fixing positions

Actuators and fixing positions

Actuators	AR49	BR47	ER47	Q	V3 R15,5	B9
Operating force - max.	N 1.2	1.2	1.2	2.8	4	4
Release force - min.	N 0.25	0.25	0.2	0.45	0.8	1
Pre-travel - max.	mm 6.2	6.2	6.2	3.2	1.45	1.5
Differential travel	mm 2.1 ±0.9	2.1 ±0.9	2.1 ±0.9	1.05 ±0.4	0.5 ±0.2	0.5 ±0.2
Total travel max.	mm 7.5	8.4	7.5	4.5	1.9	1.9

Except where otherwise indicated, the flat and roller levers are mounted as shown in the dimensional drawings (mounted on the left)..

Mounting accessories

H Horizontal single-pole mounting plate



O2 2-pole side mounting plate



K2 2-pole vertical mounting plate



Other information

Mounting - Operation
See basic technical concepts