

Push buttons diameter 12 and actuators

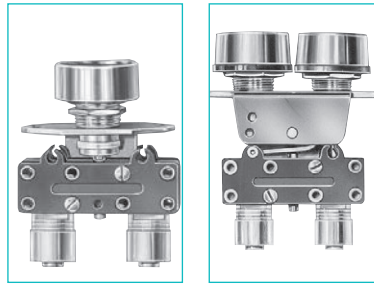

Features	Actuator color	Valve color	Push button round	Push button double round
Version	NC	black	81 735 511	—
		red	81 735 512	—
		black/red	—	81 733 511
NO	black	grey	81 735 011	—
	red	grey	—	—
	black/red	grey	—	—

Symbol

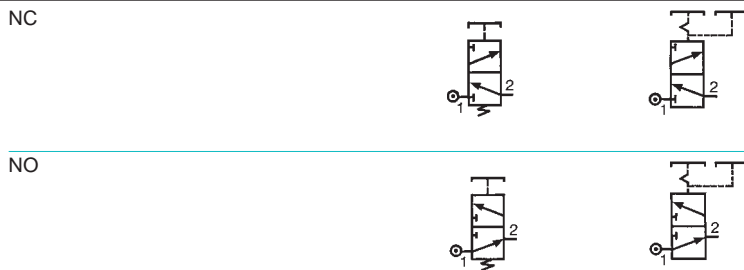

Characteristics

Operating pressure	bar	2 → 8	2 → 8
Orifice diameter	mm	2.7	2.7
Flow at 6 bars	NI/mn.	200	200
Valves	NC : black NO : grey	• •	•
Operating forces (depending on actuator)	N	8 → 18	8 → 18
Effective travel	mm	1	1
Fluid: dry or lubricated air		•	•
Push-in connectors for semi-rigid tubing (NFE 49100)	mm	Ø 4	Ø 4
Operating temperature	°C	-5 → +50	-5 → +50
Mechanical life	operations	1.5 x 10 ⁶	1.5 x 10 ⁶
Weight	g	35	40

Dimensions

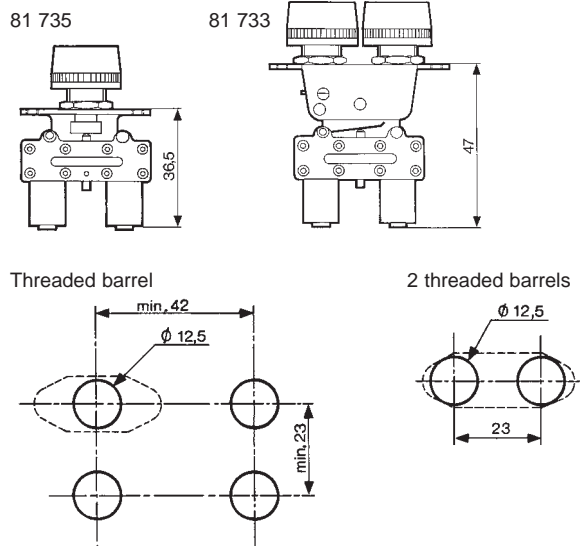

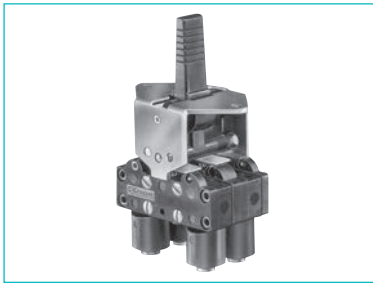

3-position lever
manual return

81 716 511	
81 716 512	
—	
—	
—	

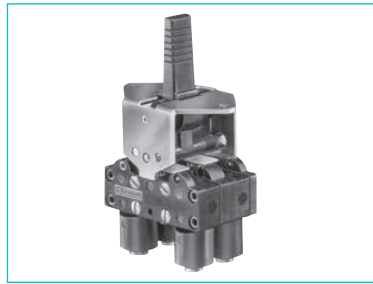

3-position lever
spring return

81 715 511	
81 715 512	
—	
—	
—	

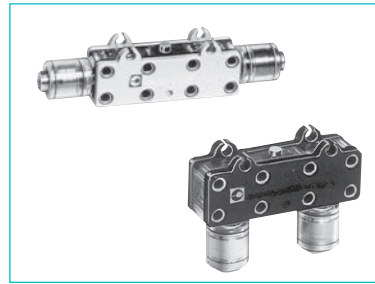

Horizontal outputs

Vertical outputs

81 280 510	81 281 510
—	—
81 280 010	81 281 010
—	—

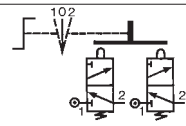
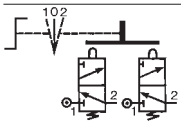

2 → 8	
2.7	
200	
•	
•	
8 → 18	
1	
•	
Ø 4	
-5 → +50	
1.5 x 10 ⁶	
65	

2 → 8	
2.7	
200	
•	
•	
8 → 18	
1	
•	
Ø 4	
-5 → +50	
1.5 x 10 ⁶	
65	

2 → 8	2 → 8
2.7	2.7
200	200
—	—
—	—
—	—
1	1
—	—
—	—
Ø 4	Ø 4
-5 → +50	-5 → +50
1.5 x 10 ⁶	1.5 x 10 ⁶
14	14

81 715 - 81 716

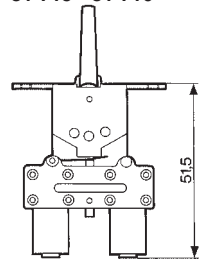

Square lever

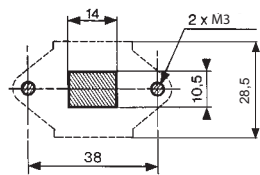

81 280 010 - 81 280 510

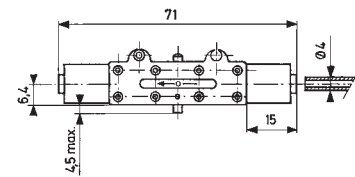

81 281 010 - 81 281 510

