

Vannes 3/2 à commande manuelle par boutons Ø 22 mm

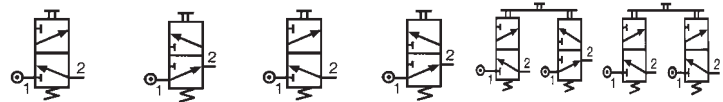

Vanne 3/2 (livrée avec vis de fixation de l'adaptateur)	Raccord Ø 4 Gaz 1/8	89 543 501	89 543 101	—	—	—	—	—
		89 543 701	89 543 201	—	—	—	—	—
Vanne(s) 3/2 montée(s) sur adaptateur (livrées avec adaptateur non monté)	Raccord Ø 4	—	—	89 543 105	89 543 005	89 543 305	89 543 205	—
Adaptateur pour vanne 3/2 sur boutons Ø 22		—	—	—	—	—	—	24 679 702
Version		NF	NO	NF	NO	NF + NO	NF + NF	

Symbole



Caractéristiques

Pression d'utilisation	bar	0 → 8	0 → 8	0 → 8	0 → 8	0 → 8	0 → 8	—
Ø de passage	mm	2	2	2	2	2	2	—
Débit à 6 bars	NI/min	112	112	112	112	112	112	—
Effort de commande	N	12,6	12,6	12,6	12,6	12,6	12,6	—
Température d'utilisation, air sec	°C	-5 → +60	-5 → +60	-5 → +60	-5 → +60	-5 → +60	-5 → +60	—
Endurance	manœuvres	1,5 x 10 ⁶	1,5 x 10 ⁶	1,5 x 10 ⁶	1,5 x 10 ⁶	1,5 x 10 ⁶	1,5 x 10 ⁶	—
Echappement non raccordable		●	●	●	●	●	●	—
Masse	g	50	50	60	60	110	110	40

Principe de fonctionnement

Version NF

Echappement

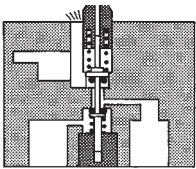

1 Alimentation 2 Utilisation

Encombrement

89 543 001 - 89 543 201

89 543 501 - 89 543 701

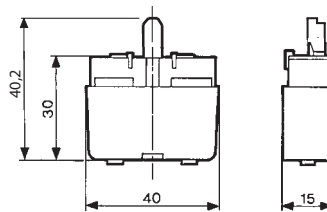

Série Ø 22

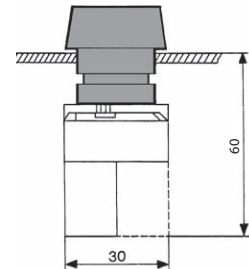

Perçage du support pour boutons Ø 22

EN 50007

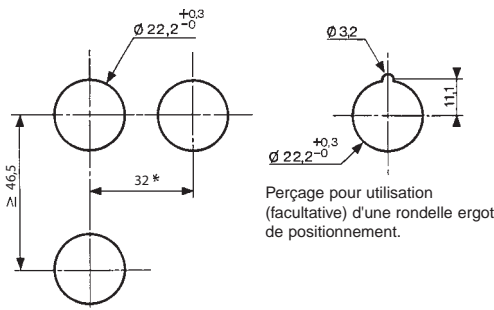



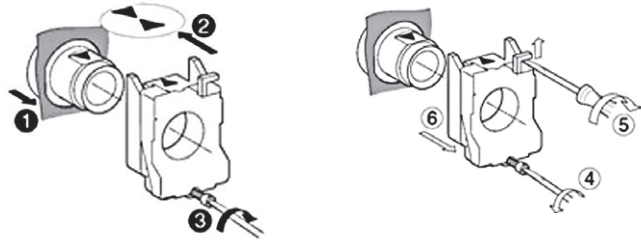

Perçage pour utilisation (facultative) d'une rondelle ergot de positionnement.

* > 40 pour poussoirs Ø 40
* > 45 pour manettes à levier

Mise en œuvre



Boutons Ø 22 mm pour vannes à commande manuelle

					
Boutons poussoirs	Rouge 24 678 129 Vert 24 678 128 Noir 24 678 127	24 678 173 — 24 678 172	24 678 171 — —	— — —	— — —
Boutons tournants 2 positions	—	—	—	24 678 174	24 678 175
Boutons tournants 3 positions	—	—	—	—	—
Actionnement	Bouton poussoir affleurant à impulsion	Bouton poussoir "coup de poing" Ø 40 plastique	Bouton poussoir "coup de poing" "pousser-tourner"	Manette symétrique noire	Manette à levier noire

Symbole



Position

					
Masse	g	30	45	45	45

Encombremments

24 678 127 - 24 678 128



24 678 171 - 24 678 172

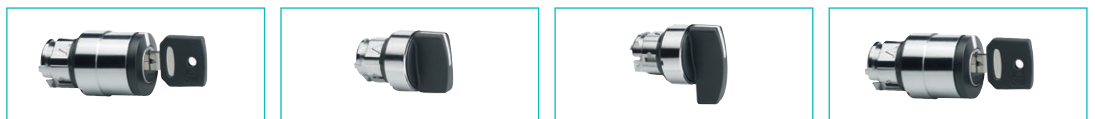
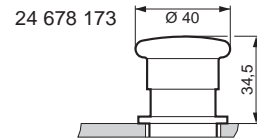







Boutons tournants 2 positions	24 678 180	—	24 678 176	24 678 178	24 678 177	24 678 179	24 678 182	24 678 181
Boutons tournants 3 positions	Clé RONIS 455 extraction position 0	Manette symétrique noire	Manette symétrique noire avec rappel	Manette à levier noire	Manette à levier noire avec rappel	Clé RONIS 455 extraction en 0 3 positions rappel au centre	Clé RONIS 455 extraction en 0 3 positions fixes	
Actionnement								

Symbole



Position

							
Masse	70	45	45	16	45	70	70

Encombremments

24 678 174 - 24 678 176

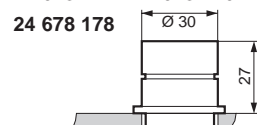

24 678 175 - 24 678 177

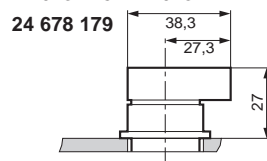

24 678 180 - 24 678 181

