

PyroMini Series Operators Guide



The PyroMini Series is a range of miniature non-contact infrared temperature sensors with separate electronics modules.

All models have an adjustable emissivity setting and are capable of measuring a wide variety of target materials, including food, paper, textiles, plastics, leather, tobacco, pharmaceuticals, chemicals, rubber, coal and asphalt.

The optional touch screen interface provides temperature indication, alarms, sensor configuration and data logging to MicroSD Card. The optional high-temperature sensing head may be used in ambient temperatures of up to 180°C without cooling. The low-noise cable on high ambient temperature models is resistant to interference from movement, so it is ideal for mounting on moving objects such as robot arms.

A choice of optics are available to measure small or large targets at short or long distances, and there is a choice of 4-20 mA, RS485 Modbus and alarm relay outputs.

SPECIFICATION

GENERAL

Temperature Range	See table of Model Numbers
Maximum Temperature Span (-CRT models)	1020°C
Minimum Temperature Span (-CRT models)	100°C
Output	4 to 20 mA or RS485 Modbus
Field of View	See table of Model Numbers
Accuracy	± 1°C or 1%, whichever is greater
Repeatability	± 0.5°C or 0.5%, whichever is greater
Emissivity Setting Range	0.20 to 1.00
Emissivity Setting Method	-CB models: via two rotary switches in electronics module -BB and -BT models: via RS485 -CRT and -BT models: via touch screen
Response Time, t_{90}	240 ms (90% response)
Spectral Range	8 to 14 μ m
Supply Voltage	24 V DC ± 5%
Maximum Current Draw	100 mA
Maximum Loop Impedance	-CB and -CRT models: 900 Ω (4 to 20 mA output)
Alarm Relays (-CRT models)	2 x Single Pole Changeover alarm relays rated 24 V DC, 1 A, isolated 500 V DC

MECHANICAL

	Sensing head	Electronics Module
Construction	Stainless Steel 316	Die-cast Aluminium
Major Dimensions	Ø18 x 45 mm	98(w) x 64(h) x 36(d) mm
Mounting	M16 x 1 mm thread	Two M4 screws for wall mounting (see diagram)

Cable Length (sensing head to electronics module)	1 m (standard), up to 30 m (optional)
Weight with 1 m Cable	390 g (approx)
Cable Connections	Removable screw terminal blocks (see Connections). Conductor size: 28 AWG to 18 AWG
Output Cable Gland	Suitable for cable diameters 3.0 to 6.5 mm

ENVIRONMENTAL

	Sensing Head	Electronics Module (without touch screen)	Electronics Module (with touch screen)
Environmental Rating	IP65 (NEMA 4)	IP65 (NEMA 4)	–
Ambient Temperature Range	See table of Model Numbers	0°C to 60°C	0°C to 60°C
Relative Humidity	Maximum 95% non-condensing	Maximum 95% non-condensing	Maximum 95% non-condensing
CE Marked	Yes	Yes	Yes
RoHS Compliant	Yes	Yes	Yes

ELECTROMAGNETIC COMPATIBILITY STANDARDS:

Class	Standard	Description
EMC Directive	EN61326-1:2006	Electrical equipment for measurement, control and laboratory use – Industrial
- Immunity	IEC 61000-4-2	Electrostatic Discharge Immunity
	IEC 61000-4-3	Electromagnetic Field Immunity
	IEC 61000-4-4	Burst Immunity
	IEC 61000-4-5	Surge Immunity
	IEC 61000-4-6	Conducted RF Immunity
- Emissions	EN 55022A	RF Emissions Class A
	EN 55022B	RF Emissions Class B

MODEL NUMBERS

The following combinations of ambient temperature range, optics, measured temperature range, output and interface are available on PyroMini sensors:

Series	Sensing Head Operating Temperature Range	Field of View	Measurement Temperature Range	Output and Interface
PM	MA	21 151 301 CF	LT MT HT XT	CB
			CT	CRT BB BRT
	HA	201	HT XT	CB
			CT	CRT BB BRT

SENSING HEAD OPERATING TEMPERATURE RANGE

- MA 0°C to 60°C
- HA 0°C to 180°C

The high ambient temperature sensing head on -HA models is capable of withstanding temperatures of up to 180°C without cooling. It is available with 20:1 optics.

There is no need to supply cooling air or water, and the miniature sensing head is much smaller than bulky, cooled sensors.

FIELD OF VIEW

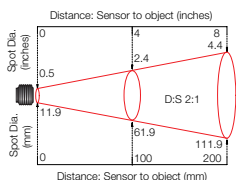

-21

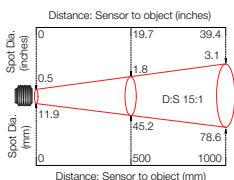

-151

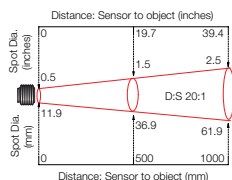

-201

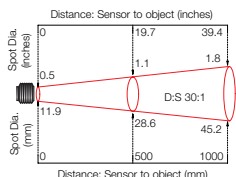

-301

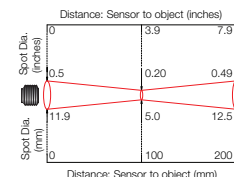

-CF

Diameter of target spot measured versus distance from sensing head at 90% energy

MEASUREMENT TEMPERATURE RANGE (°C)

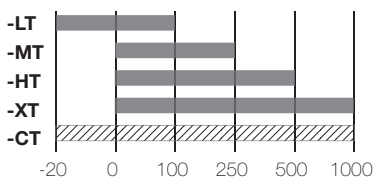

■ Fixed (e.g. -MT: 0°C @ 4 mA, 250°C @ 20 mA)

▨ -CRT models: 4 to 20 mA output configurable within this range
 -BRT and -BB models: Digital output, full temperature range

OUTPUT AND INTERFACE

- CB 4 to 20 mA output, no touch screen
- CRT 4 to 20 mA output and two alarm relay outputs, with touch screen
- BB RS485 Modbus output, no touch screen
- BRT RS485 Modbus output and two alarm relay outputs, with touch screen

EXAMPLE: PM-MA-301-CT-BRT

Series	Sensing Head Operating Temperature	Optics	Temperature Range	Output and Interface
PM PyroMini	-MA 0°C to 60°C	-301 30:1 divergent	-CT configurable within the limits: -20 to 1000 °C	-BRT RS485 Modbus output and two alarm relay outputs, with touch screen

EMISSIVITY ADJUSTMENT (-CB MODELS)

The emissivity setting on PyroMini -CB models may be adjusted via two rotary switches inside the electronics box. To adjust the emissivity setting:

Set the left switch to the first digit after the decimal point (0.1).

Set the right switch to the second digit after the decimal point (0.01).

To enter an emissivity setting of 1.00, set both switches to 0.

The minimum emissivity setting is 0.2. If a lower emissivity setting is selected, the sensor will default to an emissivity setting of 0.95.

For example:

Left switch	Right switch	Emissivity setting
6	3	0.63
0	0	1.00

TOUCH SCREEN (-CRT AND -BRT MODELS)



The optional backlit touch screen interface mounted in the lid of the electronics module provides a large, bright display of the measured temperature, as well as options for full configuration of the sensor. The graph view shows the history of the measured temperature.

In alarm conditions, the display changes colour to provide an immediate and obvious alarm indication. Alarm modes and levels can be configured via the touch screen.



TOUCH SCREEN SPECIFICATIONS



Touch Screen Display Format	2.83" (72 mm) resistive touch TFT, 320 x 240 pixels, backlit
Configurable Parameters	Temperature range, temperature units, emissivity setting, reflected energy compensation, alarms, signal processing, Modbus address (-BRT models), date and time, data logging
Temperature Units	°C or °F configurable
Temperature Resolution	0.1°
Alarm Configuration	Two alarms with adjustable level, individually configurable as HI or LO. Alarm 2 can be set to target temperature or sensing head internal temperature
Signal Processing	Average, peak hold, valley hold, minimum, maximum



USER INTERFACE

Default View	Temperature View Displays a large indication of the measured temperature. The background turns bright red when an alarm is activated.
Setting Temperature Units Selecting Displayed Temperature  	Press “°C” to switch to °F and vice versa. The units are changed throughout the interface. Press the temperature display to select which reading is shown: Filtered Temp The measured temperature, with averaging and hold processing. This temperature is output by the sensor on the 4 to 20 mA output (-CB and -CRT models). Average Temp The measured temperature with averaging but without hold processing. Unfiltered Temp The unprocessed measured temperature. MicroSD Card status. This icon is displayed when an SD card is inserted, and flashes when data logging is in progress. This icon is displayed when scheduled data logging is enabled and has yet to begin.



	List View Displays a list of the measured temperatures, alarm state and data logging state.
	Filtered Temp: The measured temperature, with averaging and hold processing. Unfiltered Temp: The unprocessed measured temperature. Average Temp: The Unfiltered Temperature averaged over the period specified in “Output Processing”. Maximum Temp: The highest temperature measured during the hold period, with averaging. Minimum Temp: The lowest temperature measured during the hold period, with averaging. Sensor Temp: The internal temperature of the sensing head. Reflected Temp: The reflected energy compensation temperature, as specified in “Emissivity and Compensation”.

 	<p>Lock/Unlock Prevents settings being changed via a four-digit numerical code.</p>
	<p>Change Password Enter, confirm and save a new four-digit code.</p>

 	<p>Start/Stop Logging Manually begins or ends data logging (requires MicroSD Card, available separately).</p> <p>If Scheduled Start is enabled in Settings > Data Logging, then logging cannot be started manually.</p> <p>To manually start logging, you must first disable Scheduled Start.</p>
--	---

	<p>Graph Displays the recent history of the Filtered Temperature and the Sensor Temperature. To scroll backwards and forwards in time, touch the graph and drag it. The graph stores the most recent 24 hours of temperature data.</p>
 	<p>Reset Graph Clears and restarts the graph.</p> <p>Real-Time Scrolling View Returns the graph to the real-time scrolling view, showing the most recent measurements.</p>

	<p>Acknowledge Alarms Switches the relay outputs for triggered alarms to their normal, untriggered state. The background of the Temperature View, List View and Graph View will stay red, and the alarms will not be triggered again, until the alarms are reset (see "Alarms" below). Alarms can be acknowledged when the display is locked.</p>
---	--

	<p>Settings Access the configuration parameters. Press Apply  to save the settings, or Exit  to leave the screen without saving.</p>
---	---

SETTINGS

	Date & Time Change the date and time for data logging purposes. The clock is reset when the power is cycled unless a battery is fitted.
---	---

	Output Processing
Averaging Period	Set the time, in seconds, over which the measured temperature is averaged. Note: averaging prevents the sensor from following rapid temperature changes. Minimum: 0 (no averaging). Maximum: 60.
Hold Mode	Peak The sensor holds the maximum temperature steady for the Hold Period. After this, the sensor responds normally. If the sensor detects a higher temperature, it holds this temperature steady for the Hold Period. Valley Similar to Peak Hold mode except that the sensor outputs the minimum detected temperature steady for the Hold Period. Off Disables hold processing.
Hold Period	Set the time, in seconds, for the sensor to hold the temperature as above. Minimum: 0 (no hold processing). Maximum: 1200.



	Data Logging
Sample Period	The time, in seconds, between samples. Minimum: 1. Maximum: 86,400 (1 day).
Number of Samples	The number of samples to collect before logging stops. Minimum: 0 (continuous logging). Maximum: 86,400 (1 day of data if Sample Period = 1 second).
Enable Scheduled Start	The sensor begins logging at the Date and Time specified. Logging can also be started and stopped manually.
Date and Time	The date and time for scheduled logging to start.

SETTINGS (continued)



	Emissivity and Compensation
Emissivity Setting	Enter the emissivity of the target. Target emissivity can be determined experimentally, or estimated using an emissivity table. For more information, contact Calex. Minimum: 0.2. Maximum: 1.0.
Enable Reflected Energy Compensation	If enabled, compensates for errors caused by reflected energy from hotter or colder objects.
Reflected Temperature	Enter the temperature of the surroundings of the target for Reflected Energy Compensation. Minimum: -20°C. Maximum: 1000°C.

	4 to 20 mA Output (-CRT models) Set the temperature range limits for the 4 to 20 mA output.
Temperature at 4 mA	The lower temperature range limit. Minimum: -20°C. Maximum: 900°C.
Temperature at 20 mA	The upper temperature range limit. Minimum: 80°C. Maximum: 1000°C.
Please note	The difference between the temperatures at 4 mA and at 20 mA must be at least 100°C. The temperature at 20 mA must be greater than the temperature at 4 mA.

	Modbus Address (-BRT models)
Modbus Address	The current Modbus address of the sensor is displayed. Enter a new address, then press Apply to save it to the sensor. Cycle the power to use the new address. Minimum: 1. Maximum: 247.

	Alarms Configure the settings for Alarm 1 and Alarm 2 separately, and configure alarm logging settings.
	Manually Reset Alarms If an alarm has been triggered, allows both alarms to be triggered again. Alarms will not be triggered again until they are reset, either automatically or manually.

SETTINGS > ALARMS

	<h3>Alarm 1 and Alarm 2</h3>
Alarm Set Point	The temperature at which the alarm is triggered. Minimum: -20°C. Maximum: 1000°C.
Hysteresis	The temperature difference between the Alarm Set Point and the reset temperature. Hysteresis is only used when Automatic Reset is enabled. Please see the diagrams below for more information Minimum: 0°C (hysteresis disabled). Maximum: 1000°C.
Filtered Temperature or Sensor Temperature (Alarm 2 only)	Select the temperature monitored by Alarm 2.
Alarm Type	High The alarm is triggered when the temperature rises above the Alarm Set Point. Low The alarm is triggered when the temperature drops below the Alarm Set Point. Off The alarm is disabled.
Reset	Automatic The alarm is acknowledged and reset automatically when the temperature reaches the reset temperature (see Hysteresis). It can also be acknowledged or reset manually. Manual The alarm is acknowledged by pressing Acknowledge  on the Temperature View or List View, and reset by pressing Reset  on the Alarms screen.

	<h3>Alarm Logging</h3> <p>Alarm events can be logged to the MicroSD Card. Alarm log files and settings are independent from Data Logging.</p>
Log Trigger Time	The time that an alarm is triggered will be logged.
Log Data While Triggered	Data logging will start when an alarm is triggered. 1 sample is logged per second. Logging stops when both alarms are reset.
Log Acknowledge Time	The time that the alarm is acknowledged will be logged.
Log Reset Time	The time that the alarm is reset will be logged.

ALARM OPERATION WITH HYSTERESIS & AUTOMATIC RESET

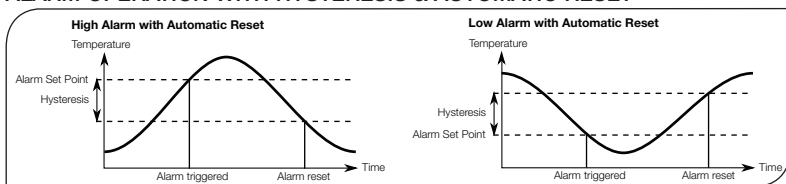

DATA LOGGING (-CRT AND -BRT MODELS)

The PyroMini can be used as a standalone data logger.

PyroMini models -CRT and -BRT include a MicroSD card slot for data logging, which can be configured via the touch screen interface. The user can select the sample rate and the number of samples to be taken and schedule the data logging to start at a certain time.

With a 2 GB card, the user can store 28.4 million readings, which provides almost 1 year's worth of data at the fastest possible sample rate of 1 per second.

Data is stored on the MicroSD card in .csv format and can be viewed and edited easily using spreadsheet software.







A MicroSD card with SD card adapter is available as an optional accessory.

The MicroSD card slot and battery holder are located on the touch screen circuit board in the lid of the PyroMini. Readings are time and date stamped using the sensor's internal clock. The clock is reset when the power is disconnected, or it will continue if the optional battery is fitted.

DATA LOGGING SPECIFICATIONS

Data Logging Interval	1 to 86,400 seconds (1 day)
MicroSD Card	Max. capacity: 2 GB (not included)
Internal Clock Battery	1 x BR 1225 3V (not included)
Variables Logged	Target temperature, sensing head temperature, electronics module temperature, max, min, average, emissivity setting, reflected energy compensation temperature
File format	.csv
Configurable Parameters	Sample period, number of samples, scheduled start date and time
Modbus address range	1 to 247

USING THE PYROMINI AS A DATA LOGGER

1. Insert a MicroSD card into the holder on the circuit board inside the lid of the PyroMini electronics module.
2. To retain the date and time when the PyroMini is switched off, fit a battery to the holder on the circuit board inside the lid.
3. Replace the lid and connect the sensor power supply.
4. To set the number of samples to be logged, the time period between samples, and, if required, to schedule data logging to automatically start, press  to access the Settings menu, then press  to access the Data Logging options.
5. To save data logging settings, press .
6. To manually start data logging, press  on the Temperature View or List View.
7. While logging is in progress, the logging icon  flashes on the Temperature View and List View.
8. To stop data logging, press .
9. To transfer data to a computer, remove the MicroSD Card from the sensor, insert the card into the SD Card adapter (supplied with MicroSD Card, accessory model MSD) and insert the adapter into an SD Card reader.

Note: MicroSDHC Cards are not compatible with the PyroMini.

INSTALLATION OF MICROSD CARD AND BATTERY

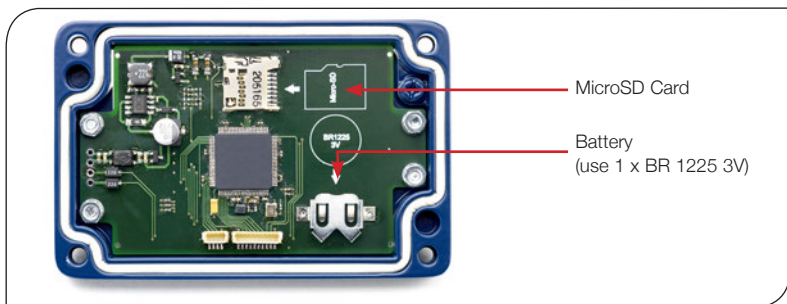

DATA LOG FILES

Data is saved to the MicroSD Card in .csv format. This file format can be opened or imported by spreadsheet software such as Microsoft Excel.

A new folder is created on the MicroSD Card for each day that data is logged.

A new log file is created every time logging is started. The start time is used as the file name.

DIMENSIONS

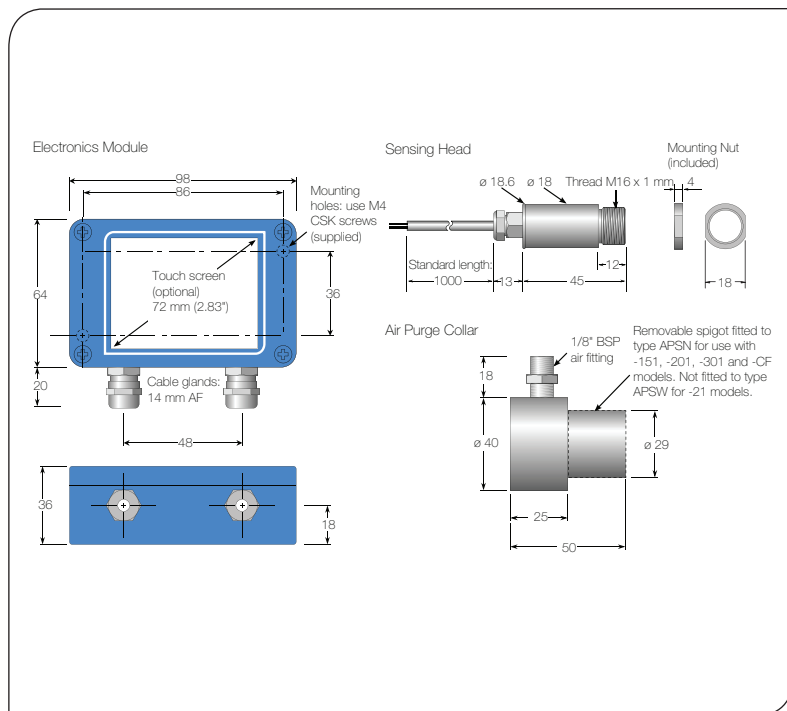

Fixed Mounting Bracket (FBS)

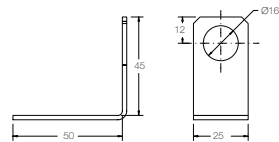

2 x Mounting Holes M4 Clearance

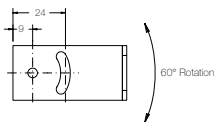

Adjustable Mounting Bracket (ABS)

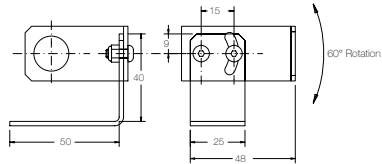

2 x Mounting Holes M4 Clearance

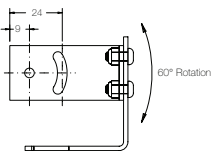

ACCESSORIES

A range of accessories to suit different applications and industrial environments is available. These may be ordered at any time and added on-site. The following accessories are available from Calex:

Fixed mounting bracket (see above for dimensions): Allows rotational adjustment in one dimension. Model number: FBS.

Adjustable mounting bracket (see above for dimensions): Allows rotational adjustment in two dimensions. Model number: ABS.

Air purge collar (see above for dimensions): The air purge collar is used to keep dust, fumes, moisture, and other contaminants away from the lens. It must be screwed fully onto the sensing head. Air flows into the 1/8" BSP fitting and out of the front aperture. Air flow should be 5 to 15 l/min. Clean or 'instrument' air is recommended. Model APSW is for use with sensors with 2:1 optics. Model APSN is for use with all other PyroMini models.

Laser sighting tool: When fitted to the sensor during installation or re-alignment, the laser sighting tool pinpoints the centre of the measured spot. Model number: LSTS.

Protective plastic window with stainless steel holder: When screwed over the lens of the sensor, this provides extra mechanical protection for the germanium lens and helps retain fragments of the lens in case of damage. The emissivity setting of the sensor should be adjusted to compensate for the presence of the window. This accessory is suitable for use in ambient temperatures of 0 to 100°C. For more information, please contact Calex. Model number: PWS

MicroSD Card: Stores logged data. For use with -BRT and -CRT models. Includes SD Card adapter. Model number: MSD.

OPTIONS

The following options are available. Options are factory installed and must be ordered with the sensor.

Calibration Certificate: UKAS traceable certificate showing the measured temperature at three points across the sensor's temperature range. Model number: CALCERTA.

Extended Cable (30 m maximum total cable length): 1 m cable is supplied with each sensor as standard. Extra cable can be added to this in increments of 1 m. Model number: PMCE (-MA models), PMCEHT (-HA models).

INSTALLATION

The installation process consists of the following stages:

Preparation

Mechanical installation

Electrical installation

Please read the following sections thoroughly before proceeding with the installation.

PREPARATION

Ensure that the sensor is positioned so that it is focused on the target only.

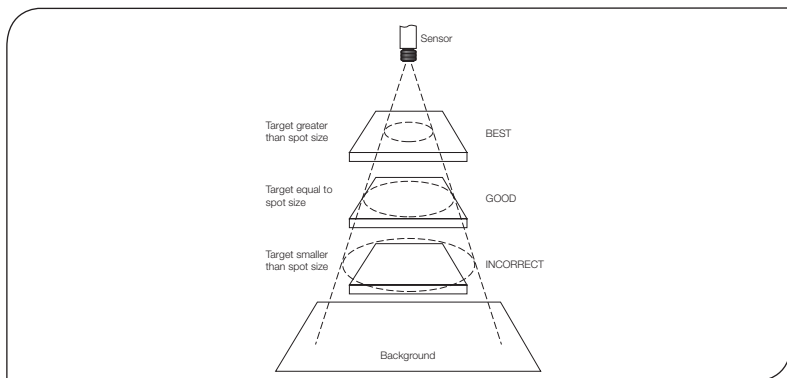

DISTANCE AND SPOT SIZE

The size of the area (spot size) to be measured determines the distance between the sensor and the target. The spot size must not be larger than the target. The sensor should be mounted so that the measured spot size is smaller than the target.

AMBIENT TEMPERATURE

The PyroMini is available with a choice of two miniature sensing heads, for use in low or high ambient temperatures:

-MA models: The sensing head is designed to operate in ambient temperatures from 0°C to 60°C.

-HA models: The sensing head is designed to operate in ambient temperatures from 0°C to 180°C. No cooling is required, which saves the energy and cost of supplying air or water to cool the sensor.

Avoid thermal shock. Allow 20 minutes for the unit to adjust to large changes in ambient temperature.

ATMOSPHERIC QUALITY

Smoke, fumes, dust or steam can contaminate the lens and cause errors in temperature measurement. In these types of environment the air purge collar should be used to help keep the lens clean.

INTERFERENCE FROM MOVEMENT

The low-noise sensing head cable on -HA models is resistant to interference caused by movement. The sensing head may be mounted on moving machinery such as robot arms without affecting the accuracy of the measured temperature.

ELECTRICAL INTERFERENCE

The PyroMini is tested to industrial standards for electromagnetic compatibility (EMC) as shown in Specifications at the beginning of this manual.

To minimise electromagnetic interference or 'noise', the sensor should be mounted away from motors, generators and such like.

POWER SUPPLY

Be sure to use a 24 V DC (100 mA) power supply.

MECHANICAL INSTALLATION

All sensors come with a 1 m cable and a mounting nut as standard. Longer cables are available to order. The sensor can be mounted on brackets or cut-outs of your own design, or you can use the fixed or adjustable mounting bracket accessories.

Note: The sensor housing must be connected to earth at one point, either the housing of the sensing head, the electronics module, or the output cable shield termination. To avoid ground loops, please ensure the sensor is grounded at only one of these points.

ELECTRICAL INSTALLATION

CONNECTIONS

-CB and -CRT models

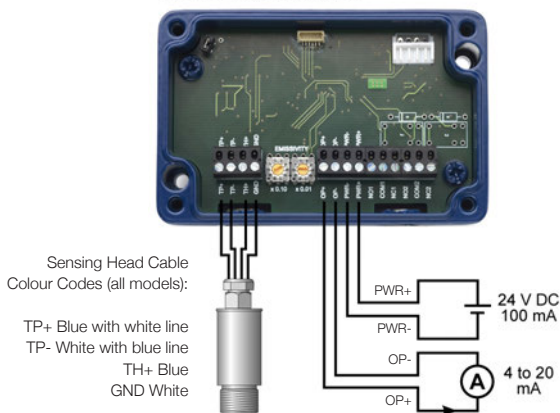

-BB and -BRT models

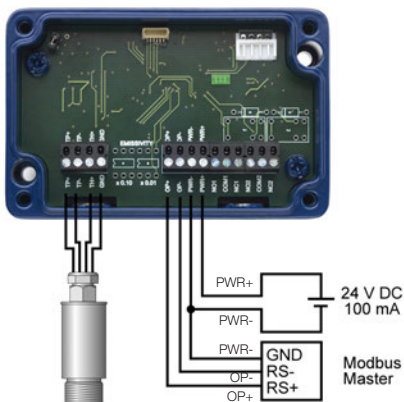

WIRING (ALL MODELS)

Check the distance between the sensing head and the electronics module, and between the electronics module and the instrumentation. If necessary, the sensor can be ordered with a longer cable between the sensing head and the electronics module.

The output cable from the electronics module should have an outer diameter between 3.0 and 6.5 mm, with conductors of size 28 to 18 AWG.

The terminal blocks in the electronics module may be removed from the circuit board for easy wiring.

Do not disconnect the touch screen circuit board from the main circuit board while the sensor is on.

WIRING (-BB AND -BRT MODELS)

When connecting several sensors in a single Modbus network, all of the sensors should be connected via a junction box to a single network bus cable, running from the furthest sensor to the Modbus Master.

Up to 247 sensors may be connected to a single Modbus network. Each sensor must have a unique Modbus address. PyroMini sensors are normally shipped with Modbus address 1. The Modbus address may be changed via the touch screen interface on -BRT models, or via Modbus.

To help prevent data reflections, please ensure the cable between each sensor and the main network bus is as short as possible. The network bus should be terminated with a resistor of 120Ω between the RS+ and RS- wires. The PWR- wire of the bus should be connected to the signal ground of the Modbus Master.

MODBUS OVER SERIAL LINE (RS485)

Interface

Baud rate	9600
Format	8 data, No parity, 1 stop bit
Reply delay (ms)	20

Supported functions

Read register	0x03, 0x04
Write single register	0x06
Write multiple register	0x10
Mask write register	0x16
Read/write	0x17

The list below includes all available addresses:

R = Read

W = Write (single, multiple or read/write)

MW = Mask write

Address	Length (words)	Description	R/W/MW
0x00	1	MODBUS slave address	R/W*
0x02	2	Sensor identification register Bits 0..19 - Serial number Bits 20..23 - Sensor type (12 = PyroMini) Bits 24..26 - Sensor field-of-view For MA : 0 = 2:1, 1 = 15:1, 2 = 30:1 For HA : 0 = 20:1 Bits 28..32 - Reserved	R

Address	Length (words)	Description	R/W/MW
0x06	1	Unfiltered object temperature	R
0x08	1	Sensor temperature	R
0x0A	1	Maximum temperature over hold period	R
0x0C	1	Minimum temperature over hold period	R
0x0E	1	Average temperature over hold period	R
0x10	1	Filtered object temperature	R
0x12	1	PCB temperature	R
0x14	1	Emissivity (1 LSB = 0.0001) Minimum 0.2000, Maximum 1.0000	R/W
0x16	1	Reflected temperature	R/W
0x18	1	Sensor status register Bits 0..1 - Reserved Bit 2 - Hold processing on (1)/off (0) Bit 3 - Hold peaks (1)/valleys (0) Bits 4..6 - Reserved Bit 7 - Reflected energy compensation on (1)/off (0) Bits 8..15 - Reserved	R/W/MW
0x1A	1	Average period (1 LSB = 0.05 seconds) Minimum 0.05 seconds, Maximum 60.00 seconds	R/W
0x1C	1	Hold period (1 LSB = 0.05 seconds) Minimum 0.05 seconds, Maximum 1200.00 seconds	R/W
0x1E	1	Temperature at 4 mA Minimum -20°C, Maximum 900°C	R/W
0x20	1	Temperature at 20 mA Minimum 80°C, Maximum 1000°C	R/W
0x22	1	Alarm 1 setpoint Minimum -20°C, Maximum 1000°C	R/W
0x24	1	Alarm 1 hysteresis Minimum 0°C, Maximum 1000°C	R/W
0x26	1	Alarm 1 status register Bit 0 – Relay triggered (R) Bit 1 – Visible alarm active (R) Bit 2 – Alarm triggered (R) Bit 3 – Auto reset (1)/manual reset (0) (R/W/MW) Bit 4 – Alarm acknowledge (R/W/MW) Bit 5 – Alarm reset (R/W/MW) Bits 6..7 – Reserved Bit 8 – High alarm (1)/low alarm (0) (R/W/MW) Bit 9 – Alarm enabled (1)/disabled (0) Bits 10..15 – Reserved	R/W/MW

Address	Length (words)	Description	R/W/MW
0x28	1	Alarm 2 status register Bit 0 – Relay triggered (R) Bit 1 – Visible alarm active (R) Bit 2 – Alarm triggered (R) Bit 3 – Auto reset (1)/manual reset (0) (R/W/MW) Bit 4 – Alarm acknowledge (R/W/MW) Bit 5 – Alarm reset (R/W/MW) Bit 6 – Reserved Bit 7 – Filtered object temperature (1)/head temperature (0) (R/W/MW) Bit 8 – High alarm (1)/low alarm (0) (R/W/MW) Bit 9 – Alarm enabled (1)/disabled (0) Bits 10..15 – Reserved	R/W/MW
0x2A	1	Alarm 2 setpoint Minimum -20°C, Maximum 1000°C	R/W
0x2C	1	Alarm 2 hysteresis Minimum 0°C, Maximum 1000°C	R/W

* Single register writes only. New address will not take effect until next power on.

Notes:

1. All temperatures are in tenths of degrees C
2. Writing to unlisted registers could cause malfunction
3. All write and mask operations are saved to non-volatile memory
4. For further information please refer to <http://www.modbus.org/specs.php>
5. Use address 255 to communicate with any connected sensor. Use address 0 to broadcast to all connected sensors (no response expected)

OPERATION

Once the sensor is in position and the appropriate power, air and cable connections are secure, the system is ready for continuous operation by completing the following simple steps:

1. Turn on the sensor power supply
2. Turn on the connected instrumentation
3. Read, monitor or log the temperature

IMPORTANT

Be aware of the following when using the sensor:

- If the sensor is exposed to significant changes in ambient temperature (hot to cold, or cold to hot), allow 20 minutes for the temperature to stabilise before taking or recording measurements.
- Do not operate the sensor near large electromagnetic fields (e.g. around arc welders or induction heaters). Electromagnetic interference can cause measurement errors.
- Wires must be connected only to the appropriate terminals.

VIEWING THROUGH A WINDOW

The PyroMini is capable of measuring the temperature of a target through a window made of a material that is transmissive to infrared radiation at 8-14 microns. The emissivity setting of the sensor should be adjusted to compensate for the presence of the window. Please contact Calex for more information on using the PyroMini with a window.

MAINTENANCE

Our customer service representatives are available for application assistance, calibration, repair, and solutions to specific problems. Contact our Service Department before returning any equipment. In many cases, problems can be solved over the telephone. If the sensor is not performing as it should, try to match the symptom below to the problem. If the table does not help, call Calnex for further advice.

Troubleshooting		
Symptom	Probable Cause	Solution
No output	No power to sensor	Check power supply
Erroneous temperature	Incorrect wire connection	Check wire colour codes
Erroneous temperature	Faulty sensor cable	Verify cable continuity
Erroneous temperature	Field of view obstruction	Remove obstruction

LENS CLEANING

Keep the lens clean at all times. Any foreign matter on the lens would affect measurement accuracy. Blow off loose particles (if not using the air purge accessory) with an air 'puffer'.

GUARANTEE

Calnex guarantees each instrument it manufactures to be free from defect in material and workmanship under normal use and service for the period of two years from the date of purchase. This guarantee extends only to the original buyer according to Calnex terms and conditions of Sale.